





# FIND IT ON TRUCK-LITE.COM

With over 8,000 available parts,  
you'll be sure to find what you need.  
Visit [www.truck-lite.com](http://www.truck-lite.com) today.



**Powerful Search**



**360° Product Images**



**Easy-To-Find Replacement Parts**



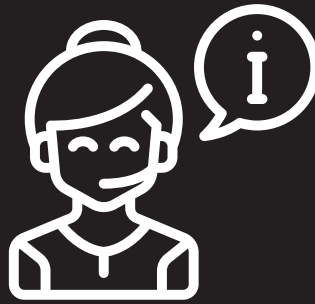

# DEDICATED SUPPORT.

When you have questions, Truck-Lite  
customer service and technical support  
have answers.



**Customer Service**

 (800) 562-5012



**Technical Support**

 (888) 562-5012



# This catalog features a new layout

## PRODUCT TYPE

The product type contains info such as series, lighting tech, shape, and mount type.

## NAVIGATION TABS

These will let you know where you are in the catalog.

## FEATURES & BENEFITS

The features & benefits contain important information pertaining to the product type.

**PRODUCT TYPE**  
LED STOP/TURN/TAIL STOP LIGHTS

**PRODUCT TYPE**  
SUPER 44, LED, 6 DIODES, 4" ROUND, FLANGE MOUNT, HARDWIRED

**NAVIGATION TABS**  
LED SUPER 44

**FEATURES & BENEFITS**  

- Faster illumination offers significant safety benefit for following drivers to react more quickly, resulting in an average distance of 3' reaction time advantage for every 10 mph
- Hardwired design results in decreased depth compared to integral plug versions, allowing for mounting in confined spaces
- LEDs have no filament, therefore are extremely resistant to shock & vibration, a major cause of failure for lamps with incandescent bulbs
- Less current draw, resulting in increased battery & alternator life while allowing more power for other vehicle requirements

**PAGE TABS**  
These are quick-info tabs that are meant to help navigate while flipping through.

**PRODUCT IMAGE**  
The product image is usually a representation of the product type. Color and connection options are listed in the product matrix.

**PRODUCT DRAWING**  
The product drawing displays its dimensions.

**PRODUCT MATRIX**  
The product matrix contains part numbers and important technical specifications.

Part Number	Lamp Connector	Plug Side 1	Plug Side 2	Lens Material	Mount Color	Volts	Amps Major/Minor	Diamond Shell
44356R	Hardwired	Hardwired	Stripped End	PC	White	12	0.3/0.03	No
44357R	Hardwired	Hardwired	Straight Female PL-3	PC	White	12	0.3/0.03	No
44360R	Hardwired	Hardwired	Packard Connector	PC	White	12	0.3/0.03	No
44361R	Hardwired	Hardwired	Male Pin	PC	White	12	0.3/0.03	No
44362R	Hardwired	Hardwired	Stripped End	PC	Gray	12	0.3/0.03	No
44363R	Hardwired	Hardwired	Straight Female PL-3	PC	Gray	12	0.3/0.03	No
44365R	Hardwired	Hardwired	Fit 'N Forget S.S.	PC	Gray	12	0.3/0.03	No
44366R	Hardwired	Hardwired	Packard Connector	PC	Gray	12	0.3/0.03	No
44367R	Hardwired	Hardwired	Male Pin	PC	Gray	12	0.3/0.03	No
44953R	Hardwired	Hardwired	Stripped End	PC	Gray	12	0.3/0.03	Yes
44954R	Hardwired	Hardwired	Straight Female PL-3	PC	Gray	12	0.3/0.03	Yes
44956R	Hardwired	Hardwired	Fit 'N Forget S.S.	PC	Gray	12	0.3/0.03	Yes
44975R	Hardwired	Hardwired	Stripped End	PC	White	12	0.3/0.03	Yes
44980R	Hardwired	Hardwired	Male Pin	PC	White	12	0.3/0.03	Yes

## PRODUCT ICONS

These icons include information such as warranty and kit call-outs.

## FYI: Common Abbreviations

**S.S = SURE SEAL**







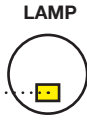
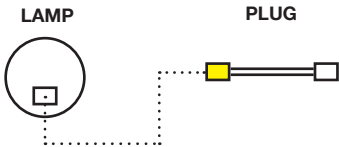
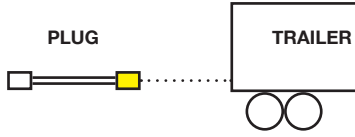





















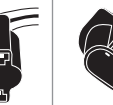





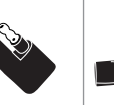
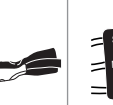

**PC = POLYCARBONATE**

**AC = ACRYLIC**

# Lamp Connector, Plug Side 1 and Plug Side 2

<h2>Connection Information</h2> <p>When it comes to choosing the correct lamps for your truck or trailer, it's important to know the connection type on your vehicle's harness.</p> <p>If the harness connector type does not match your desired light (lamp connector), you will need a plug to complete the connection.</p>	<p><b>Lamp Connector</b></p> <p>The connector type located on the back of a lamp</p> 
	<p><b>Plug Side 1</b></p> <p>The connection between a plug and a lamp</p> 
	<p><b>Plug Side 2</b></p> <p>The connection between a plug and a trailer's harness</p> 

## Common connector types we offer

PL-10 	19 Series Male Pin 	Right Angle PL-3 	Fit 'N Forget S.S. 	Fit 'N Forget M/C 	Right Angle PL-2 	Straight PL-2 	Straight PL-3 	Female Fit 'N Forget S.S. 	Female PL-10 
Female PL-3 	Female PL-2 	Super 21 Plug 	M/C Self Seal 	Male Pin 	Female Male Pin 	19 Series Hot Wire 	Female Right Angle .180 Bullet Terminal 	Female H4 Connector 	H13 Connector 
H5 Connector 	Male H4 Connector 	Ring Terminal with .180 Bullet 	Female .180 Bullet 	Deutsch Connector 	Molded Four Position .180 	2 Position .180 Bullet 	Heat Shrink Splice 	Female TA-1415 	.156 Bullet Shunt 
.180 Bullet/ Ring Terminal 	.180 Bullet 	Ring Terminal / Stripped End 	Stripped End 	.156 Bullet 	Female .156 Bullet 	Blunt Cut 			

## Product Attribute Definitions

These terms are used throughout this catalog. Here is what they all mean.

ATTRIBUTE	DEFINITION
Beacon Frequency (FPM)	The number of times a beacon flashes per minute
Beam Pattern	Light pattern type (spot, work, flood)
Breakout	Plug types that branch off from the primary harness
Bulb Wattage (W)	The specific wattage of a bulb
Center Distance (in)	Distance between plugs in inches
Common Size (in)	The general size of a product in inches
Compatible Conductor Size Range – Max	The largest compatible wire size
Compatible Conductor Size Range – Min	The smallest compatible wire size
Current Major (AMP)	Current used for a light’s “high” function measured in amps
Current Minor (AMP)	Current used for a light’s “low” function measured in amps
Current (AMP)	Electric current measured in amps
DB Level	Sound level of a back-up alarm measured in decibels
DB Level – Max	The maximum sound level of a back-up alarm measured in decibels
DB Level – Min	The minimum sound level of a back-up alarm measured in decibels
Diamond Shell (Y/N)	Durable, protective lens coating
Flasher Mechanism	Type of flasher: electro-mechanical, heavy duty solid state, thermal or solid-state
Flashing Patterns	The number of times a strobe flashes in a series (dual or quad)
Lamp Connection	A light’s integral electrical connection type—identifying the plug type required
Light Intensity (CP)	The power emitted by a light source, measured in candelas

ATTRIBUTE	DEFINITION
Lighting Technology	The method by which light is produced (LED, halogen, incandescent)
Mount Type	Method by which a lamp is mounted
Number of Plugs	The number of terminations on a harness
Open/Close	Open or closed-back grommet
Plug Side One	The side of a plug that usually mates directly with the light
Plug Side Two	The side of a plug that usually mates directly with the harness
Series	Product line, usually distinguished by product shape, size, function or technology
Sound Regulation	Single or self-adjusting sound volume
Split/Solid Pin	Pin construction
Standards Met	The regulations/certifications with which a product is designed to comply
Strobe Frequency – Max FPM	A strobe lamp's maximum number of flashes per minute
Strobe Frequency – Min FPM	A strobe lamp's minimum number of flashes per minute
Strobe Frequency (FPM)	A strobe lamp's number of flashes per minute
Warning Class	The SAE classification system for warning lights
Lumens_LM	Light intensity measure in lumens
Maximum Reflective Intensity_CP	Reflective intensity measured in candela power
Metalized/Non-Metalized	Metalized reflector is brighter
Mirror Connection	A plug that fits a type of Mirror

# TABLE OF CONTENTS

<b>Stop Lighting</b>	<b>8-53</b>
Stop/Turn/Tail	13-43
High-Mounted Stop Lights	44-47
Combination Box Lights	48-52

<b>Headlights &amp; Fog Lights</b>	<b>226-255</b>
Headlights	230-236
Fog & Driving Lights	238-247
Snow Plow Lights	248-255

<b>Signal Lighting</b>	<b>54-105</b>
Turn Signal Lights	58-75
Front/Park/Turn	76-92
Long Life Vehicle (LLV)	93
Pedestal Lights	94-105

<b>Warning &amp; Emergency Lighting</b>	<b>256-287</b>
Strobe Lights	260-273
Beacons	274-280
Light Bars	282-285
Traffic Control Light Bars	286-287

<b>Light Modules</b>	<b>106-117</b>
----------------------	----------------

<b>Interior Utility &amp; Dome Lights</b>	<b>288-307</b>
---	----------------

<b>Marker &amp; Clearance Lighting</b>	<b>118-163</b>
--	----------------

<b>Lighting Replacement Parts</b>	<b>308-337</b>
Replacement Lenses	310-318
Replacement Bulbs	320-324
Strobe Motors & Rotators	325
Strobe Mounting Magnets	326
Strobe Power Supplies	327
Flasher Modules	328-335
Relays	336-337

<b>Identification Bars</b>	<b>164-171</b>
----------------------------	----------------

<b>Personal Trailer Kits</b>	<b>172-177</b>
------------------------------	----------------

<b>License &amp; Back-Up Lighting</b>	<b>178-207</b>
License Lights	182-190
Back-Up Lights	191-206

<b>Light Mounting</b>	<b>338-385</b>
Light Housing	340-341
Light Mounting Brackets & Flanges	342-369
Light Mounting Gaskets	370-374
Light Mounting Hardware	375-378
Grommet Mounts	379-385

<b>Work Lights</b>	<b>208-225</b>
--------------------	----------------



<b>Harness</b>	<b>386-449</b>
Harnesses	390-407
Plugs	408-427
Strings	428-429
Sockets	430-431
Nose Boxes	432
Nose Box Accessories	433-434
Receptacles	435-437
Trailer Cords	438
Trailer Connector Cable Plugs	439
Junction Boxes	440-442
Junction Box Accessories	443-445
Conductor Fittings & Clips	446-447
Heat Shrink Tubing & Wire Splices	448
Fuses	449

<b>Mirrors</b>	<b>450-483</b>
Combination Mirrors	453
West Coast Mirrors	454-461
Flat Mirrors	462-469
Convex Mirrors	470-476
Mirror Brackets & Accessories	478-483

<b>Reflectors &amp; Reflective Tape</b>	<b>484-493</b>
Reflectors	486-489
Reflective Tape	490-491
Warning Triangles	492

<b>Maintenance</b>	<b>494-503</b>
Anti-Corrosion Compounds	498-499
Tester Kits & Accessories	500-502
Light Repair Kits	503

<b>Alarms &amp; Switches</b>	<b>504-517</b>
Back-Up Alarms	506-509
Turn Signal Switches	510-516

<b>Merchandising</b>	<b>518-529</b>
Display Racks & Accessories	520-523
Lighted Displays	524-528
Shop Floor Cabinet	529

<b>Technical Information</b>	<b>530-560</b>
------------------------------	----------------

<b>Numerical Index</b>	<b>561-584</b>
------------------------	----------------

# STOP LIGHTS

**STOP / TURN /TAIL**

**Pages 13-43**

## LED

SERIES	COMMON SIZE	PAGES
44® Series	4"	13
Super 44®	4"	14-20
45® Series	3" x 5"	20-21
60® Series	2" x 6"	22-25
Super 66	2" x 6"	25-26
Signal-Stat Round	4"	27
Signal-Stat Oval	2" x 6"	28
Signal-Stat Rectangular	3" x 5"	29

## INCANDESCENT

SERIES	COMMON SIZE	PAGES
40® Series	4"	30-32
40® Economy	4"	33-34
Super 40®	4"	35-36
41 Series	3" x 5"	37
Super 45®	3" x 5"	37-38
60® Series	2" x 6"	38
60® Economy	2" x 6"	38-39
Super 60®	2" x 6"	39
80 Series	4"	40
90 Series	7"	41
91® Series	7"	42
4 Screw	4" x 6"	43

# HIGH-MOUNTED STOP LIGHTS

Pages 44-47

## LED

SERIES	COMMON SIZE	PAGES
21® Series	2" x 6"	44
60® Series	2" x 6"	44-45
Adhesive Mount	1" x 9"	45

## INCANDESCENT

SERIES	COMMON SIZE	PAGES
40® Series	4"	46
45® Series	3" x 5"	46
60® Series	2" x 6"	46-47
Super 60®	2" x 6"	47

# COMBINATION BOX LIGHTS

Pages 48-52

## LED

SERIES	PAGES
2 Stud Mount	48
3 Stud Mount	48

## INCANDESCENT

SERIES	PAGES
Ford	49
Ford/Dodge	49
Freightliner	49
Freightliner/Peterbilt/ GM	49
Freightliner/Peterbilt/GM/Oshkosh	50
Navistar	50
Volvo	51
2 Stud Mount	52
3 Stud Mount	52



# Stop Lights

Whether your vehicle calls for a classic stop/turn/tail lamp or a combination box lamp, Truck-Lite has the right size, shape, material, mount and connection type for any application.

## Shapes

Round, Oval, Rectangular, Square

## Mount Types

Grommet, Flange, 2 Screw, 4 Screw

## Connection Information

When it comes to choosing the correct lamps for your truck or trailer, it's important to know the connection type on your vehicle's harness.

If the harness connector type does not match your desired light (lamp connector), you will need a plug to complete the connection.

### Lamp Connector

The connector type located on the back of a lamp

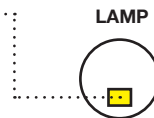

### Plug Side 1

The connection between a plug and a lamp

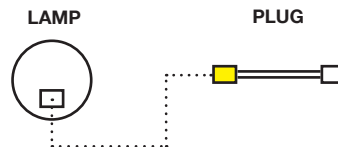





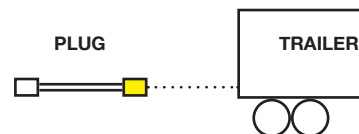





### Plug Side 2

The connection between a plug and a trailer's harness



(800) 562-5012 | [truck-lite.com](http://truck-lite.com)

 <p><b>Manufacturing &amp; Quality</b></p>	 <p><b>Testing &amp; Safety</b></p>
<p>Truck-Lite's LED stop/turn/tail lighting is built using premium materials and backed by industry-leading warranties.</p> <p>Designed to last the life of your vehicle, Truck-Lite's solid-state construction and sealed circuitry mean that you can depend on your lighting to withstand shock, vibration, moisture and debris.</p>	<p>All Truck-Lite lamps are subjected to rigorous environmental, electrical and mechanical testing before they are validated and released to the market.</p> <p>All lamps comply with FMVSS/CMVSS-108, SAE and DOT standards when properly mounted.</p>
 <p><b>Performance &amp; Maintenance</b></p>	 <p><b>Customer Support</b></p>
<ul style="list-style-type: none"> <li>• Lower energy consumption</li> <li>• Impact-resistant, non-yellowing lenses and rugged housing protect against damage from even the toughest applications</li> <li>• Robust, cost-effective design</li> </ul>	<p><b>Customer Service</b>                (800) 562-5012  <a href="mailto:customerservice@truck-lite.com">customerservice@truck-lite.com</a></p> <p><b>Technical Support</b>                (888) 562-5012  <a href="mailto:tltech@truck-lite.com">tltech@truck-lite.com</a></p> <p><b>S/T/T Light Warranties</b></p> <div style="display: flex; justify-content: space-around;">     </div>
<p>(800) 562-5012   <a href="http://truck-lite.com">truck-lite.com</a></p>	

# Looking for even more product information?

Visit [truck-lite.com](http://truck-lite.com)



**Powerful Search**



**360° Product Images**



**Easy-To-Find Replacement Parts**

## 44<sup>®</sup> SERIES, LED, 1 DIODE, 4" ROUND, GROMMET MOUNT, HARDWIRED



- Electronics completely sealed in epoxy to resist moisture & corrosion
- Lamp hardwired - wire leads incorporate .180 jacketed bullet terminals
- Sealed polycarbonate lens & housing
- Voltage 10V to 30V

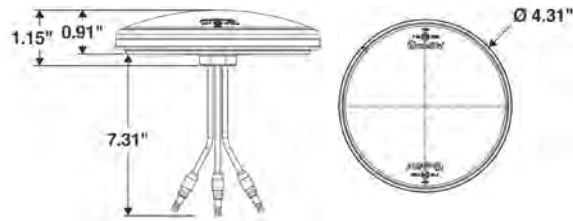

Part Number	Lamp Connector	Plug Side 1	Plug Side 2	Lens Material	Volts	Amps Major/Minor
44932R	Hardwired	Hardwired	.180 Bullet	PC	12   24	0.23 / 0.02

LED

44 SERIES

## 44<sup>®</sup> SERIES, LED, 1 DIODE, 4" ROUND, GROMMET MOUNT, HARDWIRED, KIT



- Electronics completely sealed in epoxy to resist moisture & corrosion
- Lamp hardwired - wire leads incorporate .180 jacketed bullet terminals
- Sealed polycarbonate lens & housing
- Voltage 10V to 30V

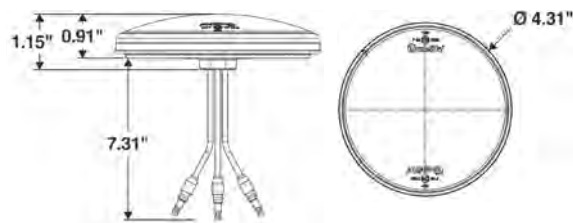

Part Number	Lamp Connector	Plug Side 1	Plug Side 2	Lens Material	Mount Color	Volts	Amps Major/Minor	Kit Includes/ Replacement Parts
44121R	Hardwired	Hardwired	.180 Bullet	PC	Black	12   24	0.23 / 0.02	44932R lamp, 40700 grommet

LED

44 SERIES

## 44<sup>®</sup> SERIES, LED, 1 DIODE, 4" ROUND, FLANGE MOUNT, HARDWIRED



- Electronics completely sealed in epoxy to resist moisture & corrosion
- Lamp hardwired - wire leads incorporate .180 jacketed bullet terminals
- Sealed polycarbonate lens & housing
- Voltage 10V to 30V

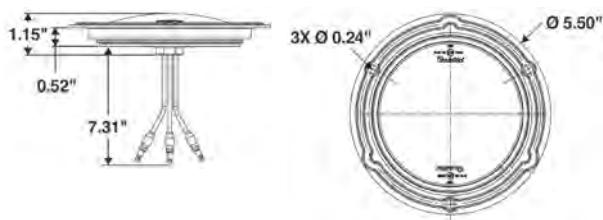

Part Number	Lamp Connector	Plug Side 1	Plug Side 2	Lens Material	Mount Color	Volts	Amps Major / Minor
44936R	Hardwired	Hardwired	.180 Bullet	PC	Black	12   24	0.23 / 0.02

LED

44 SERIES

**SUPER 44® , LED, 6 DIODES, 4" ROUND, GROMMET MOUNT**

LED

SUPER 44

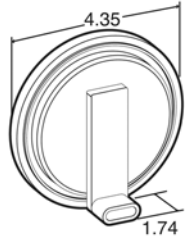

- Faster illumination offers significant safety benefit for following drivers to react more quickly, resulting in an average distance of 3' reaction time advantage for every 10 mph
- LEDs have no filament, therefore are extremely resistant to shock & vibration
- Less current draw, resulting in increased battery & alternator life while allowing more power for other vehicle requirements



Part Number	Lamp Connector	Lens Material	Volts	Amps Major/Minor	Diamond Shell
44302R	Fit 'N Forget S.S.	PC	12	0.24 / 0.03	No
44982R	Fit 'N Forget S.S.	AC	12	0.24 / 0.03	Yes

LED

SUPER 44

**SUPER 44® , LED, 6 DIODES, 4" ROUND, GROMMET MOUNT, KIT**



- Faster illumination offers significant safety benefit for following drivers to react more quickly, resulting in an average distance of 3' reaction time advantage for every 10 mph
- LEDs have no filament, therefore are extremely resistant to shock & vibration
- Less current draw, resulting in increased battery & alternator life while allowing more power for other vehicle requirements Light includes 94706 Stop/Turn/Tail adapter plug



Part Number	Lamp Connector	Plug Side 1	Plug Side 2	Lens Material	Mount Color	Volts	Amps Major/Minor	Diamond Shell	Kit Includes/ Replacement Parts
44030R	Fit 'N Forget S.S.	Fit 'N Forget S.S.	Straight Female PL-3	PC	Black	12	0.24 / 0.03	No	4700 grommet, 94706 plug
44092R	Fit 'N Forget S.S.	Fit 'N Forget S.S.	Straight Female PL-3	AC	Black	12	0.24 / 0.03	Yes	4700 grommet, 94706 plug

**Keep Your Connections Safe. Don't Forget Your Dielectric Gel.**

Dielectric gel protects your lights by protecting the points of contact between elements of your lighting and harness system. Our dielectric compounds prevent arcing and corrosion and keep your lights performing as they should.

You can find our dielectric products on page 498





# SUPER 44<sup>®</sup>, LED, 6 DIODES, 4" ROUND, GROMMET MOUNT, HARDWIRED



- Faster illumination offers significant safety benefit for following drivers to react more quickly, resulting in an average distance of 3' reaction time advantage for every 10 mph
- design results in decreased depth compared to integral plug versions, allowing for mounting in confined spaces
- LEDs have no filament, therefore are extremely resistant to shock & vibration, a major cause of failure for lamps with incandescent bulbs
- Less current draw, resulting in increased battery & alternator life while allowing more power for other vehicle requirements



Part Number	Lamp Connector	Plug Side 1	Plug Side 2	Lens Material	Volts	Amps Major/Minor	Diamond Shell
44350R	Hardwired	Hardwired	Stripped End	PC	12	0.24 / 0.03	No
44351R	Hardwired	Hardwired	Straight Female PL-3	PC	12	0.24 / 0.03	No
44353R	Hardwired	Hardwired	Fit 'N Forget S.S.	PC	12	0.24 / 0.03	No
44354R	Hardwired	Hardwired	Packard Connector	PC	12	0.24 / 0.03	No
44355R	Hardwired	Hardwired	Male Pin	PC	12	0.24 / 0.03	No
44959R	Hardwired	Hardwired	Stripped End	PC	12	0.24 / 0.03	Yes
44960R	Hardwired	Hardwired	Straight Female PL-3	PC	12	0.24 / 0.03	Yes
44972R	Hardwired	Hardwired	Fit 'N Forget S.S.	PC	12	0.24 / 0.03	Yes
44973R	Hardwired	Hardwired	Packard Connector	PC	12	0.24 / 0.03	Yes
44974R	Hardwired	Hardwired	Male Pin	PC	12	0.24 / 0.03	Yes

Stop/Turn/Tail

**Need some back-up?  
Super 44<sup>®</sup> Combo Lights  
now available.**

Receive the same safety and low-maintenance benefits of existing LED stop/turn/tail and back-up lights— now in one package.

You can find our Super 44<sup>®</sup> combo lights on page 18



Back-Up

## SUPER 44<sup>®</sup>, LED, 6 DIODES, 4" ROUND, FLANGE MOUNT

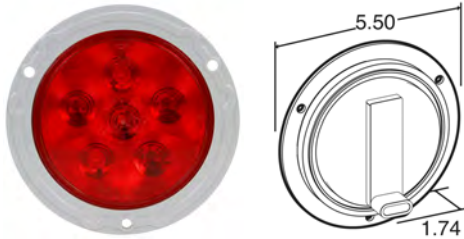

- Faster illumination offers significant safety benefit for following drivers to react more quickly, resulting in an average distance of 3' reaction time advantage for every 10 mph
- Flange mounts are permanently affixed to lamp
- LEDs have no filament, therefore are extremely resistant to shock & vibration
- Less current draw, resulting in increased battery & alternator life while allowing more power for other vehicle requirements



Part Number	Lamp Connector	Lens Material	Mount Color	Volts	Amps Major / Minor	Diamond Shell
44322R	Fit 'N Forget S.S.	PC	Gray	12	0.24 / 0.03	No
44326R	Fit 'N Forget S.S.	PC	Black	12	0.24 / 0.03	No
44328R	Fit 'N Forget S.S.	PC	White	12	0.24 / 0.03	No
44334R	Fit 'N Forget S.S.	PC	Silver	12	0.24 / 0.03	No
44983R	Fit 'N Forget S.S.	AC	Gray	12	0.24 / 0.03	Yes
44986R	Fit 'N Forget S.S.	AC	Black	12	0.24 / 0.03	Yes
44988R	Fit 'N Forget S.S.	AC	White	12	0.24 / 0.03	Yes

## SUPER 44<sup>®</sup>, LED, 6 DIODES, 4" ROUND, FLANGE MOUNT, KIT



- Faster illumination offers significant safety benefit for following drivers to react more quickly, resulting in an average distance of 3' reaction time advantage for every 10 mph
- Flange mounts are permanently affixed to lamp
- LEDs have no filament, therefore are extremely resistant to shock & vibration
- Less current draw, resulting in increased battery & alternator life while allowing more power for other vehicle requirements



Part Number	Lamp Connector	Plug Side 1	Plug Side 2	Lens Material	Mount Color	Volts	Amps Major/Minor	Diamond Shell	Kit Includes/ Replacement Parts
44032R	Fit 'N Forget S.S.	Fit 'N Forget S.S.	Straight Female PL-3	PC	Gray	12	0.24 / 0.03	No	94706 plug
44034R	Fit 'N Forget S.S.	Fit 'N Forget S.S.	Straight Female PL-3	PC	Silver	12	0.24 / 0.03	No	94706 plug
44036R	Fit 'N Forget S.S.	Fit 'N Forget S.S.	Straight Female PL-3	PC	Black	12	0.24 / 0.03	No	94706 plug
44038R	Fit 'N Forget S.S.	Fit 'N Forget S.S.	Straight Female PL-3	PC	White	12	0.24 / 0.03	No	94706 plug

## SUPER 44<sup>®</sup>, LED, 6 DIODES, 4" ROUND, FLANGE MOUNT, HARDWIRED



- Faster illumination offers significant safety benefit for following drivers to react more quickly, resulting in an average distance of 3' reaction time advantage for every 10 mph
- Hardwired design results in decreased depth compared to integral plug versions, allowing for mounting in confined spaces
- LEDs have no filament, therefore are extremely resistant to shock & vibration, a major cause of failure for lamps with incandescent bulbs
- Less current draw, resulting in increased battery & alternator life while allowing more power for other vehicle requirements



Part Number	Lamp Connector	Plug Side 1	Plug Side 2	Lens Material	Mount Color	Volts	Amps Major/Minor	Diamond Shell
44356R	Hardwired	Hardwired	Stripped End	PC	White	12	0.24 / 0.03	No
44357R	Hardwired	Hardwired	Straight Female PL-3	PC	White	12	0.24 / 0.03	No
44360R	Hardwired	Hardwired	Packard Connector	PC	White	12	0.24 / 0.03	No
44361R	Hardwired	Hardwired	Male Pin	PC	White	12	0.24 / 0.03	No
44362R	Hardwired	Hardwired	Stripped End	PC	Gray	12	0.24 / 0.03	No
44363R	Hardwired	Hardwired	Straight Female PL-3	PC	Gray	12	0.24 / 0.03	No
44365R	Hardwired	Hardwired	Fit 'N Forget S.S.	PC	Gray	12	0.24 / 0.03	No
44366R	Hardwired	Hardwired	Packard Connector	PC	Gray	12	0.24 / 0.03	No
44367R	Hardwired	Hardwired	Male Pin	PC	Gray	12	0.24 / 0.03	No
44953R	Hardwired	Hardwired	Stripped End	AC	Gray	12	0.24 / 0.03	Yes
44954R	Hardwired	Hardwired	Straight Female PL-3	AC	Gray	12	0.24 / 0.03	Yes
44956R	Hardwired	Hardwired	Fit 'N Forget S.S.	AC	Gray	12	0.24 / 0.03	Yes
44975R	Hardwired	Hardwired	Stripped End	AC	White	12	0.24 / 0.03	Yes
44980R	Hardwired	Hardwired	Male Pin	AC	White	12	0.24 / 0.03	Yes

## Keep Your Connections Safe. Don't Forget Your Dielectric Gel.

Dielectric gel protects your lights by protecting the points of contact between elements of your lighting and harness system. Our dielectric compounds prevent arcing and corrosion and keep your lights performing as they should.

You can find our dielectric products on page 498



## SUPER 44<sup>®</sup>, LED, 8 DIODES, 4" ROUND, GROMMET MOUNT, S/T/T + BACK-UP COMBO, HARDWIRED

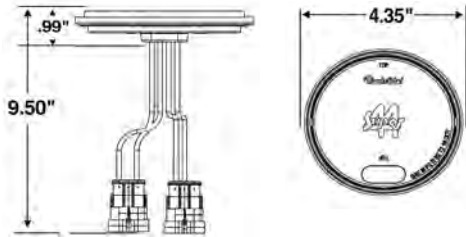

- Offers the same safety and low-maintenance benefits of existing LED S/T/T and BU lights now in one package
- Complies with FMVSS requirement for minimum of 75 cm<sup>2</sup> of luminous red area
- Saves space in inventory when stocking a two-in-one product
- New combination lamps are the same size as existing Truck-Lite Model 44 lights, so they fit into existing mounting holes
- Lower-cost system when replacing other hardwired 44 products



Part Number	Lamp Connector	Plug Side 1	Plug Side 2	Lens Material	Lens Color	Volts	Amps Major/Minor	Diamond Shell
44353R	Hardwired	Hardwired	Fit 'N Forget S.S.	PC	Red   Clear	12	0.24 / 0.03	No

## SUPER 44<sup>®</sup>, LED, 8 DIODES, 4" ROUND, FLANGE MOUNT, S/T/T + BACK-UP COMBO, HARDWIRED

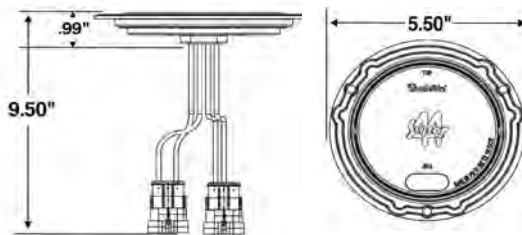

- Offers the same safety and low-maintenance benefits of existing LED S/T/T and BU lights now in one package
- Complies with FMVSS requirement for minimum of 75 cm<sup>2</sup> of luminous red area
- Saves space in inventory when stocking a two-in-one product
- New combination lamps are the same size as existing Truck-Lite Model 44 lights, so they fit into existing mounting holes
- Lower-cost system when replacing other hardwired 44 products



Part Number	Lamp Connector	Plug Side 1	Plug Side 2	Lens Material	Lens Color	Mount Color	Volts	Amps Major/Minor	Diamond Shell
44550R	Hardwired	Hardwired	Fit 'N Forget S.S.	PC	Red   Clear	Black	12	0.24 / 0.03	No
44551R	Hardwired	Hardwired	Fit 'N Forget S.S.	PC	Red   Clear	Gray	12	0.24 / 0.03	No

## SUPER 44<sup>®</sup>, LED, 17 DIODES, 4" ROUND, GROMMET MOUNT



- Faster illumination offers significant safety benefit for following drivers to react more quickly, resulting in an average distance of 3' reaction time advantage for every 10 mph
- LEDs have no filament, therefore are extremely resistant to shock & vibration
- Less current draw, resulting in increased battery & alternator life while allowing more power for other vehicle requirements

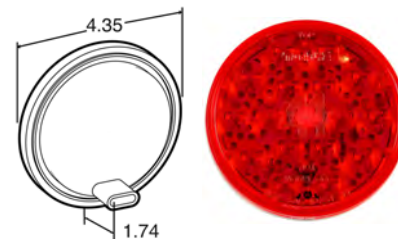

Part Number	Lamp Connector	Lens Material	Volts	Amps Major/Minor	Diamond Shell
44253R	Fit 'N Forget S.S.	PC	24	0.13 / 0.04	No

## SUPER 44<sup>®</sup>, LED, 17 DIODES, 4" ROUND, FLANGE MOUNT



- Faster illumination offers significant safety benefit for following drivers to react more quickly, resulting in an average distance of 3' reaction time advantage for every 10 mph
- Flange mounts are permanently affixed to lamp
- LEDs have no filament, therefore are extremely resistant to shock & vibration
- Less current draw, resulting in increased battery & alternator life while allowing more power for other vehicle requirements

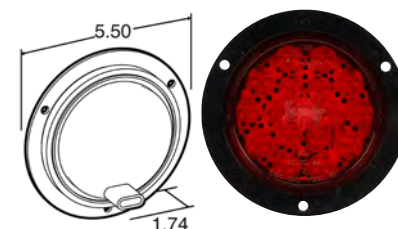

Part Number	Lamp Connector	Lens Material	Mount Color	Volts	Amps Major / Minor	Diamond Shell
44266R	Fit 'N Forget S.S.	PC	Black	24	0.13 / 0.04	No

## SUPER 44<sup>®</sup>, LED, 42 DIODES, 4" ROUND, GROMMET MOUNT



- Faster illumination offers significant safety benefit for following drivers to react more quickly, resulting in an average distance of 3' reaction time advantage for every 10 mph
- LEDs have no filament, therefore are extremely resistant to shock & vibration
- Less current draw, resulting in increased battery & alternator life while allowing more power for other vehicle requirements



Part Number	Lamp Connector	Lens Material	Volts	Amps Major/Minor	Diamond Shell
44202R	Fit 'N Forget S.S.	PC	12	0.5 / 0.1	No
44882R	Fit 'N Forget S.S.	AC	12	0.5 / 0.1	Yes

## SUPER 44<sup>®</sup>, LED, 42 DIODES, 4" ROUND, GROMMET MOUNT, KIT



- Faster illumination offers significant safety benefit for following drivers to react more quickly, resulting in an average distance of 3' reaction time advantage for every 10 mph
- Flange mounts are permanently affixed to lamp
- LEDs have no filament, therefore are extremely resistant to shock & vibration
- Less current draw, resulting in increased battery & alternator life while allowing more power for other vehicle requirements



Part Number	Lamp Connector	Plug Side 1	Plug Side 2	Lens Material	Mount Color	Volts	Amps Major/Minor	Diamond Shell	Kit Includes/ Replacement Parts
44002R	Fit 'N Forget S.S.	Fit 'N Forget S.S.	Straight Female PL-3	PC	Black	12	0.5 / 0.1	No	4700 grommet, 94706 plug
44082R	Fit 'N Forget S.S.	Fit 'N Forget S.S.	Straight Female PL-3	AC	Black	12	0.5 / 0.1	Yes	4700 grommet, 94706 plug

## SUPER 44<sup>®</sup>, LED, 42 DIODES, 4" ROUND, FLANGE MOUNT

LED

SUPER 44

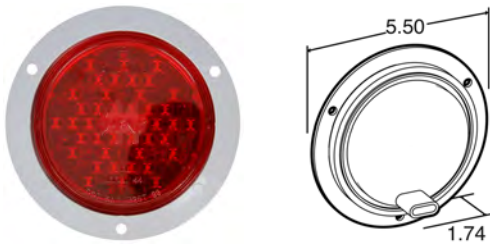

- Faster illumination offers significant safety benefit for following drivers to react more quickly, resulting in an average distance of 3' reaction time advantage for every 10 mph
- Flange mounts are permanently affixed to lamp
- LEDs have no filament, therefore are extremely resistant to shock & vibration
- Less current draw, resulting in increased battery & alternator life while allowing more power for other vehicle requirements



Part Number	Lamp Connector	Lens Material	Mount Color	Volts	Amps Major / Minor	Diamond Shell
44226R	Fit 'N Forget S.S.	PC	Black	12	0.5 / 0.1	No
44222R	Fit 'N Forget S.S.	PC	Gray	12	0.5 / 0.1	No
44883R	Fit 'N Forget S.S.	AC	Gray	12	0.5 / 0.1	Yes

## SUPER 44<sup>®</sup>, LED, 42 DIODES, 4" ROUND, FLANGE MOUNT, KIT

LED

SUPER 44

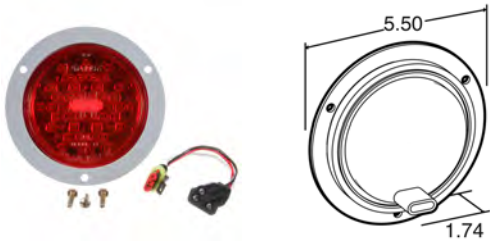

- Faster illumination offers significant safety benefit for following drivers to react more quickly, resulting in an average distance of 3' reaction time advantage for every 10 mph
- Flange mounts are permanently affixed to lamp
- LEDs have no filament, therefore are extremely resistant to shock & vibration
- Less current draw, resulting in increased battery & alternator life while allowing more power for other vehicle requirements



Part Number	Lamp Connector	Plug Side 1	Plug Side 2	Lens Material	Mount Color	Volts	Amps Major/Minor	Diamond Shell	Kit Includes/ Replacement Parts
44026R	Fit 'N Forget S.S.	Fit 'N Forget S.S.	Straight Female PL-3	PC	Black	12	0.5 / 0.1	No	94706 plug
44022R	Fit 'N Forget S.S.	Fit 'N Forget S.S.	Straight Female PL-3	PC	Gray	12	0.5 / 0.1	No	94706 plug
44083R	Fit 'N Forget S.S.	Fit 'N Forget S.S.	Straight Female PL-3	AC	Gray	12	0.5 / 0.1	Yes	94706 plug

## 45<sup>®</sup> SERIES, LED, 15 DIODES, 3"X 5", GROMMET MOUNT

LED

45 SERIES

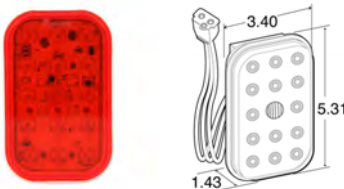

- Mount horizontally or vertically
- Specifically designed for use in trailer & body applications



Part Number	Lamp Connector	Plug Side 1	Plug Side 2	Lens Material	Volts	Amps Major/Minor
45258R	Hardwired	Hardwired	Straight Female PL-3	AC	12   24	0.25 / 0.01

## 45<sup>®</sup> SERIES, LED, 15 DIODES, 3"X 5", GROMMET MOUNT, KIT



- Mount horizontally or vertically
- Specifically designed for use in trailer & body applications



Part Number	Lamp Connector	Plug Side 1	Plug Side 2	Lens Material	Mount Color	Volts	Amps Major/Minor	Kit Includes/ Replacement Parts
45058R	Hardwired	Hardwired	Straight Female PL-3	AC	Black	12   24	0.25/0.01	45700 grommet, 45250 lamp

## 45<sup>®</sup> SERIES, LED, 15 DIODES, 3"X 5", FLANGE MOUNT



- Mount horizontally or vertically.
- Specifically designed for use in trailer & body applications

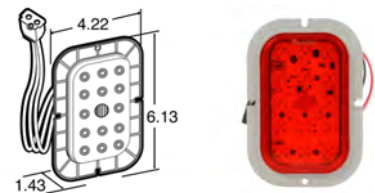

Part Number	Lamp Connector	Plug Side 1	Plug Side 2	Lens Material	Mount Color	Volts	Amps Major/Minor
45259R	Hardwired	Hardwired	Straight Female PL-3	AC	Gray	12   24	0.25 / 0.01

## 45<sup>®</sup> SERIES, LED, 19 DIODES, 3"X 5", GROMMET MOUNT, KIT



- Direct pin-to-circuit board solders assure vibration resistant contacts
- ECE approved for rear position/stop direction indicator and rear fog functions

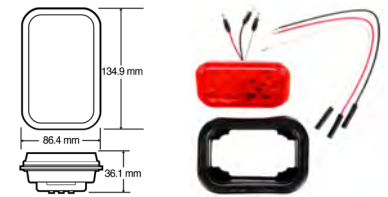

Part Number	Lamp Connector	Plug Side 1	Plug Side 2	Lens Material	Mount Color	Volts	Amps Major/Minor	Kit Includes/ Replacement Parts
45042R	Hardwired	Hardwired	.180 Bullet	PC	Black	12   24	0.28 / 0.03	45700 grommet, 45932R lamp

## 45<sup>®</sup> SERIES, LED, 24 DIODES, 3"X 5", GROMMET MOUNT



- Direct pin-to-circuit board solders assure vibration resistant contacts
- ECE approved for rear position/stop direction indicator and rear fog functions
- Electronics completely sealed in epoxy to resist corrosion & moisture
- Lamps are hardwired with standard 0.180 molded bullet connectors
- LEDs are less susceptible to shock & vibration
- Low current draw, leaving more power for other vehicle universal lighting products

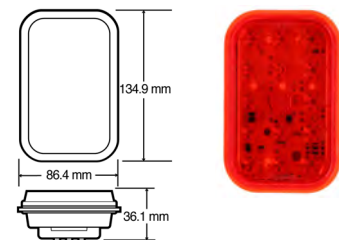

Part Number	Lamp Connector	Plug Side 1	Plug Side 2	Lens Material	Volts	Amps Major/Minor
45932R	Hardwired	Hardwired	.180 Bullet	PC	12 24	0.28/0.03

## 60<sup>®</sup> SERIES, LED, 8 DIODES, 2" X 6" OVAL, GROMMET MOUNT, S/T/T + BACK-UP COMBO

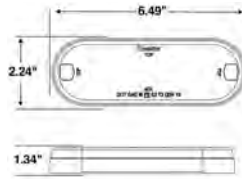

- Offers the same safety and low maintenance benefits of existing LED S/T/T and BU lights now in one package
- Not orientation dependent; complies with FMVSS 108 vertically or horizontally
- Save space in inventory
- Lower-cost system
- The new combination lamps are the same size as existing Truck-Lite Model 60 lights, which means they fit into existing mounting holes



Part Number	Lamp Connector	Lens Material	Lens Color	Volts	Amps Major/Minor	Diamond Shell
60557R	Fit 'N Forget 4 Pin S.S.	PC	Red   Clear	12	0.24/0.02	No

## 60<sup>®</sup> SERIES, LED, 8 DIODES, 2" X 6" OVAL, GROMMET MOUNT, S/T/T + BACK-UP COMBO, HARDWIRED

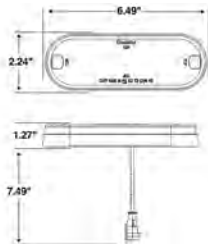

- Offers the same safety and low maintenance benefits of existing LED S/T/T and BU lights now in one package
- Not orientation dependent; complies with FMVSS 108 vertically or horizontally
- Save space in inventory
- Lower-cost system
- The new combination lamps are the same size as existing Truck-Lite Model 60 lights, which means they fit into existing mounting holes



Part Number	Lamp Connector	Plug Side 1	Plug Side 2	Lens Material	Lens Color	Volts	Amps Major/Minor	Diamond Shell
60556R	Hardwired	Hardwired	Fit 'N Forget S.S.	PC	Red   Clear	12	0.24/0.02	No

## 60<sup>®</sup> SERIES, LED, 8 DIODES, 2" X 6" OVAL, SURFACE MOUNT, S/T/T + BACK-UP COMBO

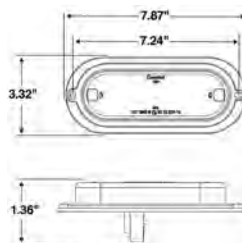

- Offers the same safety and low maintenance benefits of existing LED S/T/T and BU lights now in one package
- Not orientation dependent; complies with FMVSS 108 vertically or horizontally
- Save space in inventory
- Lower-cost system
- The new combination lamps are the same size as existing Truck-Lite Model 60 lights, which means they fit into existing mounting holes



Part Number	Lamp Connector	Lens Material	Lens Color	Mount Color	Volts	Amps Major/Minor	Diamond Shell
60555R	Fit 'N Forget 4 Pin S.S.	PC	Red   Clear	Black	12	0.24/0.02	No



## 60<sup>®</sup> SERIES, LED, 8 DIODES, 2" X 6" OVAL, SURFACE MOUNT, S/T/T + BACK-UP COMBO, HARDWIRED



- Offers the same safety and low maintenance benefits of existing LED S/T/T and BU lights now in one package
- Not orientation dependent; complies with FMVSS 108 vertically or horizontally
- Save space in inventory
- Lower-cost system
- The new combination lamps are the same size as existing Truck-Lite Model 60 lights, which means they fit into existing mounting holes



Part Number	Lamp Connector	Plug Side 1	Plug Side 2	Lens Material	Lens Color	Mount Color	Volts	Amps Major/Minor	Diamond Shell
60554R	Hardwired	Hardwired	Fit 'N Forget S.S.	PC	Red   Clear	Black	12	0.24/0.02	No

## 60<sup>®</sup> SERIES, LED, 8 DIODES, 2" X 6" OVAL, FLUSH MOUNT, S/T/T + BACK-UP COMBO



- Offers the same safety and low maintenance benefits of existing LED S/T/T and BU lights now in one package
- Not orientation dependent; complies with FMVSS 108 vertically or horizontally
- Save space in inventory
- Lower-cost system
- The new combination lamps are the same size as existing Truck-Lite Model 60 lights, which means they fit into existing mounting holes

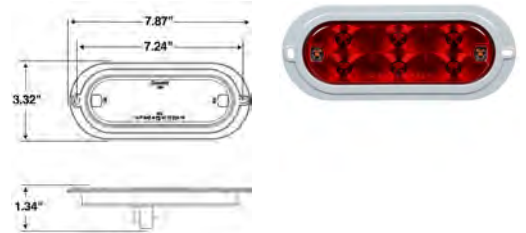

Part Number	Lamp Connector	Lens Material	Lens Color	Mount Color	Volts	Amps Major/Minor	Diamond Shell
60552R	Fit 'N Forget 4 Pin S.S.	PC	Red   Clear	Black	12	0.24/0.02	No
60553R	Fit 'N Forget 4 Pin S.S.	PC	Red   Clear	Gray	12	0.24/0.02	No

## 60<sup>®</sup> SERIES, LED, 8 DIODES, 2" X 6" OVAL, FLUSH MOUNT, S/T/T + BACK-UP COMBO, HARDWIRED



- Offers the same safety and low maintenance benefits of existing LED S/T/T and BU lights now in one package
- Not orientation dependent; complies with FMVSS 108 vertically or horizontally
- Save space in inventory
- Lower-cost system
- The new combination lamps are the same size as existing Truck-Lite Model 60 lights, which means they fit into existing mounting holes



Part Number	Lamp Connector	Plug Side 1	Plug Side 2	Lens Material	Lens Color	Mount Color	Volts	Amps Major/Minor	Diamond Shell
60550R	Hardwired	Hardwired	.180 Bullet	PC	Red   Clear	Black	12	0.24/0.02	No
60551R	Hardwired	Hardwired	Fit 'N Forget S.S.	PC	Red   Clear	Gray	12	0.24/0.02	No

## 60<sup>®</sup> SERIES, LED, 18 DIODES, 2"X 6" OVAL, FLANGE MOUNT

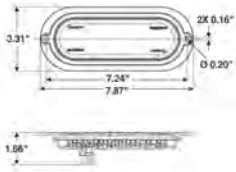

- Features a PL-3 connector
- Ideal for vehicles featuring liftgates
- Shallow curved lens profile allows for flush mounting in applications where space is at a premium



Part Number	Lamp Connector	Lens Material	Mount Color	Volts	Amps Major / Minor	Diamond Shell
60356R	PL-3	PC	Black	12	0.36/0.07	No

## 60<sup>®</sup> SERIES, LED, 26 DIODES, 2"X 6" OVAL, GROMMET MOUNT

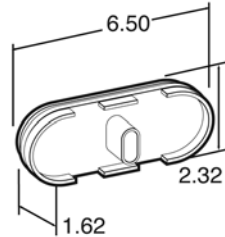

- Faster illumination offers significant safety benefit for following drivers to react quicker, resulting in average 3' reaction time advantage for every 10 mph



Part Number	Lamp Connector	Lens Material	Volts	Amps Major / Minor	Diamond Shell
60250R	Fit 'N Forget S.S.	PC	12	0.34/0.04	No
60253R	Fit 'N Forget S.S.	PC	24	0.34/0.04	No
60264R	Fit 'N Forget S.S.	AC	24	0.34/0.04	Yes
60885R	Fit 'N Forget S.S.	AC	12	0.34/0.04	Yes

## 60<sup>®</sup> SERIES, LED, 26 DIODES, 2"X 6" OVAL, GROMMET MOUNT, KIT

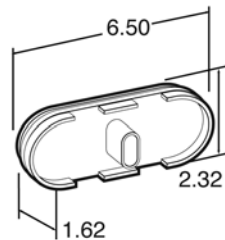

- Faster illumination offers significant safety benefit for following drivers to react quicker, resulting in average 3' reaction time advantage for every 10 mph



Part Number	Lamp Connector	Plug Side 1	Plug Side 2	Lens Material	Mount Color	Volts	Amps Major/Minor	Diamond Shell	Kit Includes/ Replacement Parts
60050R	Fit 'N Forget S.S.	Fit 'N Forget S.S.	Straight Female PL-3	PC	Black	12	0.34/0.04	No	4700 grommet, 94706 plug
60085R	Fit 'N Forget S.S.	Fit 'N Forget S.S.	Straight Female PL-3	AC	Black	12	0.34/0.04	Yes	4700 grommet, 94706 plug

## 60<sup>®</sup> SERIES, LED, 26 DIODES, 2"X 6" OVAL, FLANGE MOUNT



- Faster illumination offers significant safety benefit for following drivers to react more quickly, resulting in average 3' reaction time advantage for every 10 mph

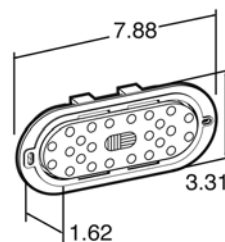

Part Number	Lamp Connector	Lens Material	Mount Color	Volts	Amps Major / Minor	Diamond Shell
60252R	Fit 'N Forget S.S.	PC	Gray	12	0.34/0.04	No
60256R	Fit 'N Forget S.S.	PC	Black	12	0.34/0.04	No

LED

60 SERIES

## 60<sup>®</sup> SERIES, LED, 26 DIODES, 2"X 6" OVAL, FLANGE MOUNT, KIT



- Faster illumination offers significant safety benefit for following drivers to react more quickly, resulting in average 3' reaction time advantage for every 10 mph

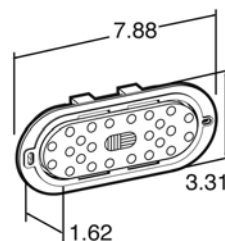

Part Number	Lamp Connector	Plug Side 1	Plug Side 2	Lens Material	Mount Color	Volts	Amps Major/Minor	Diamond Shell	Kit Includes/ Replacement Parts
60052R	Fit 'N Forget S.S.	Fit 'N Forget S.S.	Straight Female PL-3	PC	Gray	12	0.34/0.04	No	4700 grommet, 94706 plug
60056R	Fit 'N Forget S.S.	Fit 'N Forget S.S.	Straight Female PL-3	PC	Black	12	0.34/0.04	No	4700 grommet, 94706 plug

LED

60 SERIES

## SUPER 66, LED, 1 DIODE, 2"X 6" OVAL, GROMMET MOUNT



- Designed to look more like a standard incandescent lamp but has more light output
- Less current draw, resulting in increased battery & alternator life while allowing more power for other vehicle requirements
- World's first single diode LED stop, turn & tail lamp

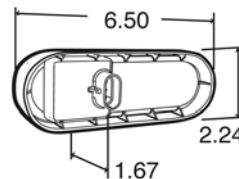

Part Number	Lamp Connector	Lens Material	Volts	Amps Major / Minor	Diamond Shell
66250R	Fit 'N Forget S.S.	PC	12	0.47/0.03	No

LED

SUPER 66

## SUPER 66, LED, 1 DIODE, 2"X 6" OVAL, GROMMET MOUNT, KIT

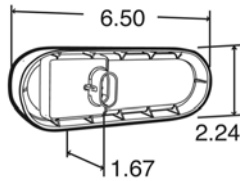

- Designed to look more like a standard incandescent lamp but has more light output
- Less current draw, resulting in increased battery & alternator life while allowing more power for other vehicle requirements
- World's first single siode LED stop, turn & tail lamp



Part Number	Lamp Connector	Plug Side 1	Plug Side 2	Lens Material	Mount Color	Volts	Amps Major/Minor	Diamond Shell	Kit Includes/ Replacement Parts
66885R	Fit 'N Forget S.S.	Fit 'N Forget S.S.	Straight Female PL-3	AC	Black	12	0.47/0.03	Yes	4700 grommet, 94706 plug
66050R	Fit 'N Forget S.S.	Fit 'N Forget S.S.	Straight Female PL-3	PC	Black	12	0.47/0.03	No	4700 grommet, 94706 plug
66085R	Fit 'N Forget S.S.	Fit 'N Forget S.S.	Straight Female PL-3	AC	Black	12	0.47/0.03	Yes	4700 grommet, 94706 plug

## SUPER 66, LED, 1 DIODE, 2"X 6" OVAL, FLANGE MOUNT

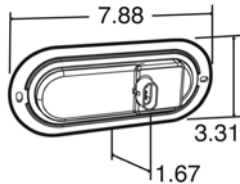

- Designed to look more like a standard incandescent lamp but has more light output
- Less current draw, resulting in increased battery & alternator life while allowing more power for other vehicle requirements
- World's first single siode LED stop, turn & tail lamp



Part Number	Lamp Connector	Lens Material	Mount Color	Volts	Amps Major / Minor	Diamond Shell
66252R	Fit 'N Forget S.S.	PC	Gray	12	0.47/0.03	No
66254R	Fit 'N Forget S.S.	PC	White	12	0.47/0.03	No
66256R	Fit 'N Forget S.S.	PC	Black	12	0.47/0.03	No
66882R	Fit 'N Forget S.S.	AC	Gray	12	0.47/0.03	Yes

## SUPER 66, LED, 1 DIODE, 2"X 6" OVAL, FLANGE MOUNT, KIT

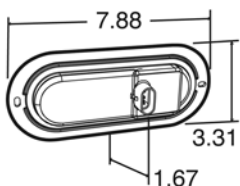

- Designed to look more like a standard incandescent lamp but has more light output
- Less current draw, resulting in increased battery & alternator life while allowing more power for other vehicle requirements
- World's first single siode LED stop, turn & tail lamp



Part Number	Lamp Connector	Plug Side 1	Plug Side 2	Lens Material	Mount Color	Volts	Amps Major/Minor	Diamond Shell	Kit Includes/ Replacement Parts
66052R	Fit 'N Forget S.S.	Fit 'N Forget S.S.	Straight Female PL-3	PC	Gray	12	0.47/0.03	No	66252R lamp, 97406 plug
66054R	Fit 'N Forget S.S.	Fit 'N Forget S.S.	Straight Female PL-3	PC	White	12	0.47/0.03	No	66254R lamp, 97406 plug
66056R	Fit 'N Forget S.S.	Fit 'N Forget S.S.	Straight Female PL-3	PC	Black	12	0.47/0.03	No	66256R lamp, 97406 plug
66082R	Fit 'N Forget S.S.	Fit 'N Forget S.S.	Straight Female PL-3	AC	Gray	12	0.47/0.03	Yes	66882R lamp, 97406 plug

## SIGNAL-STAT, LED, 10 DIODES, 4" ROUND, GROMMET MOUNT



- Uses standard PL-3 connector When properly mounted, exceeds FMVSS-P2 DOT requirements for marker/clearance performance
- Designed with impact-resistant acrylic material
- Sealed lens and housing locks moisture out
- Snap fit grommet requires no screws for installation LEDs do not have a filament, therefore are not susceptible to shock and vibration damage major cause of failure for lamps with an incandescent bulb.
- Epoxy encapsulated electronics prevents damage from moisture and corrosion.

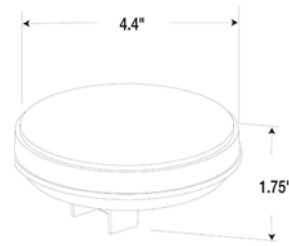

Part Number	Lamp Connector	Lens Material	Volts	Amps Major/Minor
4058	PL-3	AC	12	0.12 / 0.02

## SIGNAL-STAT, LED, 24 DIODES, 4" ROUND, GROMMET MOUNT



- Epoxy encapsulated electronics prevents damage from moisture & corrosion
- Unique LED array displays a full pattern light output design
- Uses standard right angle connection

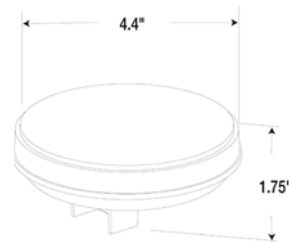

Part Number	Lamp Connector	Lens Material	Lens Color	Volts	Amps Major/Minor
4050	PL-3	PC	Red	12	0.14 / 0.01
4051	PL-3	PC	Red   Clear	12	0.14 / 0.01

## SIGNAL-STAT, LED, 24 DIODES, 4" ROUND, FLANGE MOUNT



- Uses standard right angle PL-3 connection
- Designed with impact-resistant polycarbonate material
- LEDs do not have a filament, therefore are not susceptible to damage from shock and vibration
- Epoxy encapsulated electronics prevents damage from moisture and corrosion
- When properly mounted, exceeds FMVSS DOT requirements for S/T/T and F/P/T

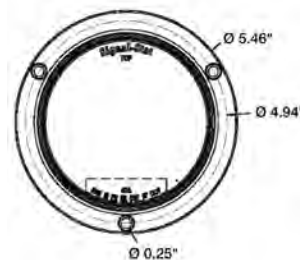

Part Number	Lamp Connector	Lens Material	Mount Color	Volts	Amps Major/Minor
4053	PL-3	PC	Gray	12	0.14 / 0.01

## SIGNAL-STAT, LED, 10 DIODES, 2"X 6" OVAL, GROMMET MOUNT

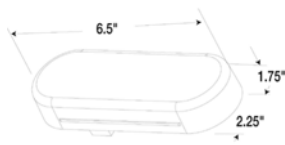

- When properly mounted, exceeds FMVSS-P2 DOT requirements for marker/clearance performance
- Designed with impact-resistant acrylic material
- Sealed lens and housing locks moisture out
- Snap fit grommet requires no screws for installation
- LEDs do not have a filament, therefore are not susceptible to damage from shock and vibration
- Epoxy encapsulated electronics prevents damage from moisture and corrosion
- Popular on owner/operator and show trucks



Part Number	Lamp Connector	Lens Material	Volts	Amps Major / Minor
6058	PL-3	AC	12	0.17/0.02

## SIGNAL-STAT, LED, 24 DIODES, 2"X 6" OVAL, GROMMET MOUNT

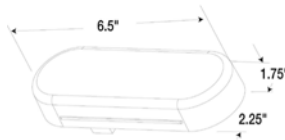

- Epoxy encapsulated electronics prevents damage from moisture & corrosion
- Unique LED array displays full pattern light output design
- Uses standard right angle plug



Part Number	Lamp Connector	Lens Material	Lens Color	Volts	Amps Major / Minor
6050	PL-3	PC	Red	12	0.26/0.02
6051	PL-3	PC	Red   Clear	12	0.26/0.02

## SIGNAL-STAT, LED, 24 DIODES, 2"X 6" OVAL, FLANGE MOUNT

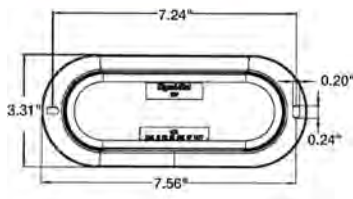

- Housing and flange are molded together to form one piece
- Uses standard right angle PL-3 connection
- Designed with impact-resistant polycarbonate material
- LEDs do not have a filament, therefore are not susceptible to shock and vibration damage - a major cause of failure for lamps with an incandescent bulb
- Epoxy encapsulated electronics prevents damage from moisture and corrosion
- When properly mounted, exceeds FMVSS DOT requirements for S/T/T and F/P/T



Part Number	Lamp Connector	Lens Material	Mount Color	Volts	Amps Major / Minor
6053	PL-3	PC	Gray	12	0.26/0.02

## SIGNAL-STAT, LED, 10 DIODES, 3"X 5" REC., GROMMET MOUNT



- Uses standard right angle PL-3 connection
- Unique LED array displays full pattern light output Epoxy encapsulated electronics

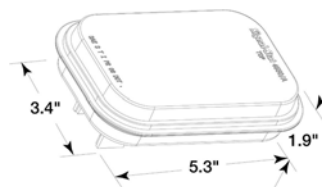

Part Number	Lamp Connector	Lens Material	Volts	Amps Major/Minor
4558	PL-3	AC	12	0.28 / 0.03

LED

SIGNAL-STAT

## SIGNAL-STAT, LED, 24 DIODES, 3"X 5" REC., GROMMET MOUNT



- 24 diode pattern
- Unique LED array displays full pattern light output
- Uses standard right angle PL-3 connection

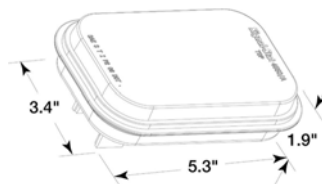

Part Number	Lamp Connector	Lens Material	Volts	Amps Major/Minor
4550	PL-3	AC	12	0.38 / 0.03

LED

SIGNAL-STAT

## Keep Your Connections Safe. Don't Forget Your Dielectric Gel.

Dielectric gel protects your lights by protecting the points of contact between elements of your lighting and harness system. Our dielectric compounds prevent arcing and corrosion and keep your lights performing as they should.

You can find our dielectric products on page 498



## 40<sup>®</sup> SERIES, INCANDESCENT, 1 BULB, 4" ROUND, GROMMET MOUNT

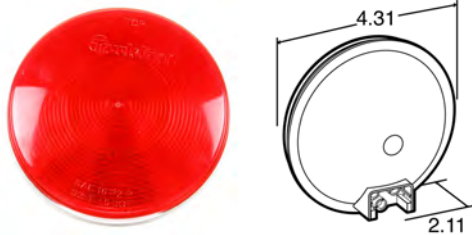

- Shock mount absorbs road shock & vibration, extending lamp life
- Welded connections eliminate failures caused by arcing
- Heavy-duty bulb offers long-lasting life
- Features clear back housing
- Grommet kit features flush mounting in a 4-1/2" hole
- Not recommended for clearance marker applications
- Welded connections eliminate failures caused by arcing



Part Number	Lamp Connector	Lens Material	Volts	Amps Major/Minor
40202R	PL-3	PC	12	2.1/0.48
40209R	PL-3	PC	24	0.93/0.34
49202R	Male Pin	PC	12	2.1/0.48

## 40<sup>®</sup> SERIES, INCANDESCENT, 1 BULB, 4" ROUND, GROMMET MOUNT, KIT



- Flush-mount grommets are designed for mounting in a 4-1/2" hole
- Heavy-duty bulb last longer
- Shock mount absorbs road shock & vibration, extending lamp life
- Welded connections eliminate failures caused by arcing



Part Number	Lamp Connector	Plug Side 1	Plug Side 2	Lens Material	Mount Color	Volts	Amps Major/Minor	Kit Includes/ Replacement Parts
40002R	PL-3	Right Angle PL-3	Stripped End/ Ring Terminal	PC	Black	12	2.1/0.48	40700 grommet, 94993 plug, 40202R lamp
40009R	PL-3	Right Angle PL-3	Stripped End/ Ring Terminal	PC	Black	24	0.93/0.34	40700 grommet, 94993 plug, 40209R lamp
49002R	Male Pin	Male Pin	Stripped End/ Ring Terminal	PC	Black	12	2.1/0.48	40700 grommet, 96107 plug

## 40<sup>®</sup> SERIES, INCANDESCENT, 1 BULB, 4" ROUND, GROMMET MOUNT, SNAP FIT, KIT



- Replaces 40302R/Y and 40318R/Y
- Polycarbonate lens and housing
- Grommet features flush mounting in a 4-1/2" hole



Part Number	Lamp Connector	Plug Side 1	Plug Side 2	Lens Material	Mount Color	Volts	Amps Major/Minor	Kit Includes/ Replacement Parts
40302R	Twist Socket	Twist Socket	Stripped End/ Ring Terminal	PC	Black	12	2.1/0.48	40700 grommet, 94938 bulb/plug, 99010R housing



## 40<sup>®</sup> SERIES, INCANDESCENT, 1 BULB, 4" ROUND, GROMMET MOUNT, CLEAR BACK



- Features clear back housing
- Shock mount absorbs road shock & vibration, extending lamp life
- Welded connections eliminate failures caused by arcing
- Heavy-duty bulb offers long-lasting life
- Uniquely designed shock-mount extends lamp life
- Not recommended for clearance marker applications
- Welded connections eliminate failures caused by arcing

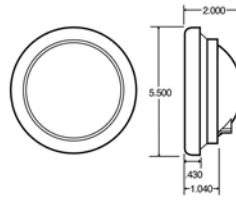

Part Number	Lamp Connector	Lens Material	Volts	Amps Major/Minor
40206R	PL-3	PC	12	2.1/0.48

INCANDESCENT

40 SERIES

## 40<sup>®</sup> SERIES, INCANDESCENT, 1 BULB, 4" ROUND, GROMMET MOUNT, CLEAR BACK, KIT



- Features clear back housing
- Not recommended for clearance marker applications
- Grommet kit features flush mounting in a 4-1/2" hole

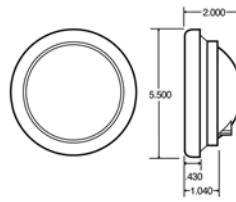

Part Number	Lamp Connector	Plug Side 1	Plug Side 2	Lens Material	Mount Color	Volts	Amps Major/Minor	Kit Includes/ Replacement Parts
40006R	PL-3	Right Angle PL-3	Stripped End/ Ring Terminal	PC	Black	12	2.1/0.48	40700 grommet, 94993 plug, 40206R lamp

INCANDESCENT

40 SERIES

## 40<sup>®</sup> SERIES, INCANDESCENT, 1 BULB, GROMMET MOUNT, REFLECTORIZED



- Flush mount grommets are designed for mounting in a 4-1/2" hole
- Heavy-duty bulb offers long-lasting life
- Reflectorized lens
- Uniquely designed shock-mount extends lamp life

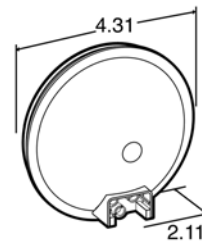

Part Number	Lamp Connector	Lens Material	Volts	Amps Major/Minor
40215R	PL-3	PC	12	2.1/0.48
40232R	PL-3	PC	24	0.93/0.34

INCANDESCENT

40 SERIES

## 40<sup>®</sup> SERIES, INCANDESCENT, 1 BULB, 4" ROUND, GROMMET MOUNT, REFLECTORIZED, KIT



- Flush-mount grommets are designed for mounting in a 4-1/2" hole
- Heavy-duty bulb offers long-lasting life
- Reflectorized lens
- Uniquely designed shock-mount extends lamp life



Part Number	Lamp Connector	Plug Side 1	Plug Side 2	Lens Material	Mount Color	Volts	Amps Major/Minor	Kit Includes/ Replacement Parts
40015R	PL-3	Right Angle PL-3	Stripped End/Ring Terminal	PC	Black	12	2.1 / 0.48	40700 grommet, 94993 plug, 40215R lamp

## 40<sup>®</sup> SERIES, INCANDESCENT, 1 BULB, 4" ROUND, FLANGE MOUNT

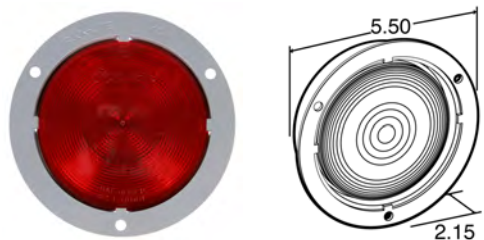

- Flush-mount grommets are designed for mounting in a 4-1/2" hole
- Gray flange mounts are permanently affixed to housing



Part Number	Lamp Connector	Lens Material	Mount Color	Volts	Amps Major/Minor
40222R	PL-3	PC	Gray	12	2.1/0.48

## 40<sup>®</sup> SERIES, INCANDESCENT, 1 BULB, 4" ROUND, FLANGE MOUNT, KIT

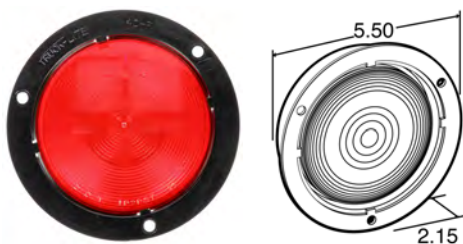

- Flush-mount grommets are designed for mounting in a 4-1/2" hole
- Heavy-duty bulb offers long-lasting life
- Uniquely designed shock-mount extends lamp life



Part Number	Lamp Connector	Plug Side 1	Plug Side 2	Lens Material	Mount Color	Volts	Amps Major/Minor
40233R	PL-3	Right Angle PL-3	Stripped End/Ring Terminal	PC	Black	12	2.1/0.48

## 40<sup>®</sup> ECONOMY, INCANDESCENT, 1 BULB, 4" ROUND, GROMMET MOUNT



- Flange kits feature a high impact plastic affixed to lamp
- Grommet kit features flush mounting in a 4-1/2" hole

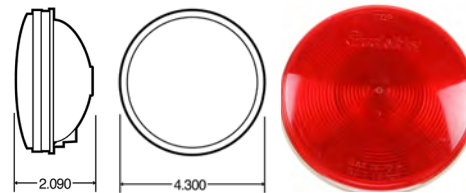

Part Number	Lamp Connector	Lens Material	Volts	Amps Major/Minor
40282R	PL-3	PC	12	2.1/0.48

INCANDESCENT

40 ECONOMY

## 40<sup>®</sup> ECONOMY, INCANDESCENT, 1 BULB, 4" ROUND, GROMMET MOUNT, KIT



- Flange kits feature a high-impact plastic affixed to lamp
- Grommet kit features flush mounting in a 4-1/2" hole

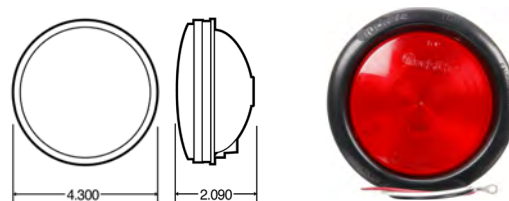

Part Number	Lamp Connector	Plug Side 1	Plug Side 2	Lens Material	Mount Color	Volts	Amps Major/Minor	Kit Includes/ Replacement Parts
40028R	PL-3	Right Angle PL-3	Stripped End/ Ring Terminal	PC	Black	12	2.1/0.48	40700 grommet, 94993 plug, 40282R lamp

INCANDESCENT

40 ECONOMY

## Keep Your Connections Safe. Don't Forget Your Dielectric Gel.

Dielectric gel protects your lights by protecting the points of contact between elements of your lighting and harness system. Our dielectric compounds prevent arcing and corrosion and keep your lights performing as they should.

You can find our dielectric products on page 498



## 40<sup>®</sup> ECONOMY, INCANDESCENT, 1 BULB, 4" ROUND, GROMMET MOUNT, REFLECTORIZED

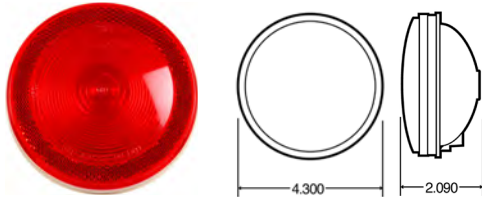

- Flange kits feature a high impact plastic affixed to lamp
- Grommet kit features flush mounting in a 4-1/2" hole



Part Number	Lamp Connector	Lens Material	Volts	Amps Major/Minor
40285R	PL-3	PC	12	2.16/0.47

## 40<sup>®</sup> ECONOMY, INCANDESCENT, 1 BULB, 4" ROUND, FLANGE MOUNT

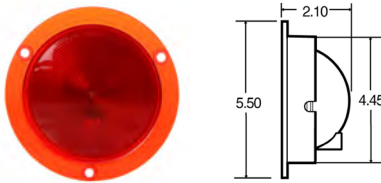

- Flange kits feature a high impact plastic affixed to lamp
- Grommet kit features flush mounting in a 4-1/2" hole



Part Number	Lamp Connector	Lens Material	Mount Color	Volts	Amps Major/Minor
40229R	PL-3	PC	Red	12	2.16/0.47

## 40<sup>®</sup> ECONOMY, INCANDESCENT, 1 BULB, 4" ROUND, FLANGE MOUNT, KIT

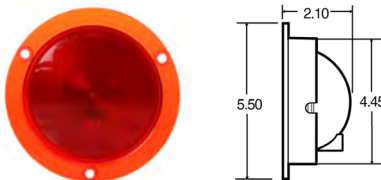

- Flange kits feature a high impact plastic affixed to lamp
- Grommet kit features flush mounting in a 4-1/2" hole



Part Number	Lamp Connector	Plug Side 1	Plug Side 2	Lens Material	Mount Color	Volts	Amps Major/Minor	Kit Includes/ Replacement Parts
40029R	PL-3	Straight PL-3	Stripped End/ Ring Terminal	PC	Red	12	2.16/0.47	40229R lamp, 94993 plug

## SUPER 40<sup>®</sup>, INCANDESCENT, 1 BULB, 4" ROUND, GROMMET MOUNT



- Uniquely designed shock-mount extends lamp life

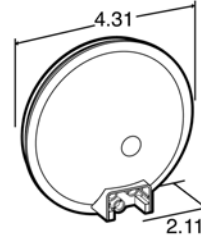

Part Number	Lamp Connector	Lens Material	Volts	Amps Major/Minor
40242R	PL-3	PC	12	2.16/0.47

INCANDESCENT

SUPER 40

## SUPER 40<sup>®</sup>, INCANDESCENT, 1 BULB, 4" ROUND, GROMMET MOUNT, KIT



- 8 square inch (illuminating) stop/turn lens area for vehicles under 80 inches wide
- Meets reflex, tail or clearance function for vehicles over 80 inches wide (Use part# 40248R)
- Flush-mount grommets are designed for mounting in a 4 1/2" hole
- Uniquely designed shock-mount extends lamp life
- Upgrade to LED lighting systems using Truck-Lite's Super 44 series

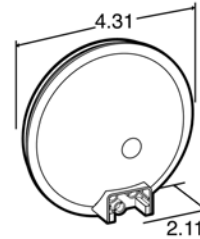

Part Number	Lamp Connector	Plug Side 1	Plug Side 2	Lens Material	Mount Color	Volts	Amps Major/Minor	Kit Includes/ Replacement Parts
40042R	PL-3	Right Angle PL-3	Stripped End/ Ring Terminal	PC	Black	12	2.16/0.47	40700 grommet, 94993 plug, 40242R lamp

INCANDESCENT

SUPER 40

## SUPER 40<sup>®</sup>, INCANDESCENT, 1 BULB, 4" ROUND, GROMMET MOUNT, REFLECTORIZED



- Uniquely designed shock-mount extends lamp life

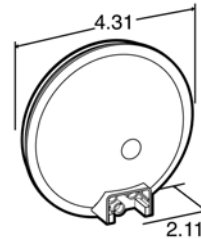

Part Number	Lamp Connector	Lens Material	Volts	Amps Major/Minor
40248R	PL-3	PC	12	2.16/0.47

INCANDESCENT

SUPER 40

## SUPER 40<sup>®</sup>, INCANDESCENT, 1 BULB, 4" ROUND, GROMMET MOUNT, REFLECTORIZED, KIT

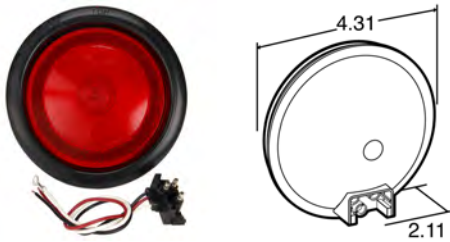

- Flush mount grommets are designed for mounting in a 4-1/2" hole
- ReflectORIZED lens



Part Number	Lamp Connector	Plug Side 1	Plug Side 2	Lens Material	Mount Color	Volts	Amps Major/Minor	Kit Includes/ Replacement Parts
40048R	PL-3	Right Angle PL-3	Stripped End/ Ring Terminal	PC	Black	12	2.16/0.47	40700 grommet, 94993 plug, 40248R lamp

## SUPER 40<sup>®</sup>, INCANDESCENT, 1 BULB, 4" ROUND, FLANGE MOUNT

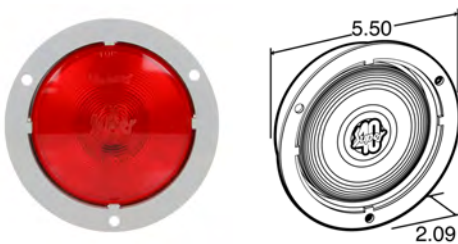

- Uniquely designed shock-mount extends lamp life



Part Number	Lamp Connector	Lens Material	Mount Color	Volts	Amps Major/Minor
40258R	PL-3	PC	Gray	12	2.16/0.47
40259R	PL-3	PC	Black	12	2.16/0.47

## SUPER 40<sup>®</sup>, INCANDESCENT, 1 BULB, 4" ROUND, FLANGE MOUNT, KIT

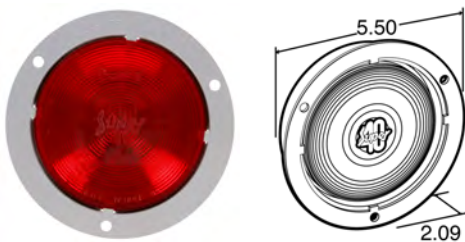

- Uniquely designed shock-mount extends lamp life



Part Number	Lamp Connector	Plug Side 1	Plug Side 2	Lens Material	Mount Color	Volts	Amps Major/Minor	Kit Includes/ Replacement Parts
40058R	PL-3	Right Angle PL-3	Stripped End/ Ring Terminal	PC	Gray	12	2.16/0.47	94993 plug, 40258R lamp

## 41 SERIES, INCANDESCENT, 1 BULB, 3"X 5", FLANGE MOUNT



- Mounts in 7.83" x 4.43" hole
- Requires separate reflector to meet legal requirements

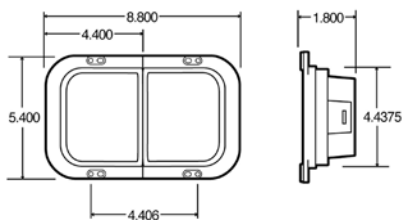

Part Number	Position	Lamp Connector	Lens Material	Mount Color	Volts	Amps Major/Minor
41202R	LH	PL-3	PC	White	12	2.1/0.48
41203R	RH	PL-3	PC	White	12	2.1/0.48

INCANDESCENT

41 SERIES

## 41 SERIES, INCANDESCENT, 1 BULB, 3"X 5", FLANGE MOUNT, KIT



- Mounts in 7.83" x 4.43" hole
- Requires separate reflector to meet legal requirements

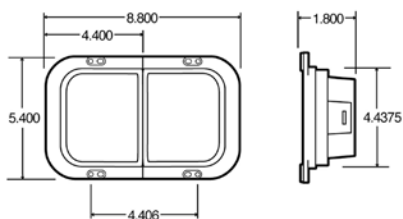

Part Number	Position	Lamp Connector	Plug Side 1	Plug Side 2	Lens Material	Mount Color	Volts	Amps Maj/Min	Kit Includes/ Replacement Parts
41005R	LH	PL-3	Straight PL-3	Ring Terminal/Molded Four-Position .180	PC	White	12	2.1/0.48	94948 plug, 41202R lamp, 41203R lamp
41006R	RH	PL-3	Straight PL-3	Ring Terminal/Molded Four-Position .180	PC	White	12	2.1/0.48	94949 plug, 41202R lamp, 41203R lamp
41007R	Universal	PL-3	Straight PL-3	Stripped End/ Ring Terminal	PC	White	12	2.1/0.48	94926 plug, 41202R lamp, 41203R lamp
41008R	Universal	PL-3	Straight PL-3	Ring Terminal/ 2-Position Plug	PC	White	12	2.1/0.48	41202R, 41203R lamp

INCANDESCENT

41 SERIES

## SUPER 45<sup>®</sup>, INCANDESCENT, 1 BULB, 3"X 5", GROMMET MOUNT



- Heavy-duty dual filament cartridge bulb
- Mount horizontally or vertically
- Unique shock mount absorbs shock & vibration

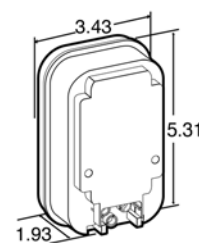

Part Number	Lamp Connector	Lens Material	Volts	Amps Major/Minor
45202R	PL-3	PC	12	2.16/0.47

INCANDESCENT

SUPER 45

## SUPER 45<sup>®</sup>, INCANDESCENT, 1 BULB, 3"X 5" REC., GROMMET MOUNT, KIT

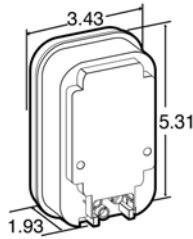

- Heavy-duty dual filament cartridge bulb
- Mount horizontally or vertically
- Unique shock mount absorbs shock & vibration



Part Number	Lamp Connector	Plug Side 1	Plug Side 2	Lens Material	Mount Color	Volts	Amps Major/Minor	Kit Includes/ Replacement Parts
45002R	PL-3	Hardwired	Stripped End/Ring Terminal	PC	Black	12	2.16/0.47	94993 plug, 45700 grommet, 45202R lamp

## 60<sup>®</sup> SERIES, INCANDESCENT, 1 BULB, 2"X 6" OVAL, GROMMET MOUNT, HARDWIRED, KIT

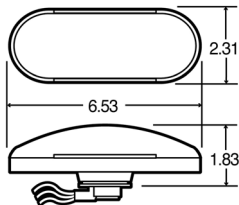

- Lamp may be either grommet or screw-mounted
- Mounts horizontally or vertically



Part Number	Lamp Connector	Plug Side 1	Plug Side 2	Lens Material	Mount Color	Volts	Amps Major/Minor	Kit Includes/ Replacement Parts
60302R	Hardwired	Hardwired	Stripped End/Ring Terminal	PC	Gray	12	2.1/0.48	99011R lamp
60340R	Hardwired	Hardwired	Stripped End/Ring Terminal	PC	Black	12	2.1/0.48	95407 bulb, 99184R lamp

## 60<sup>®</sup> ECONOMY, INCANDESCENT, 1 BULB, 2"X 6" OVAL, GROMMET MOUNT

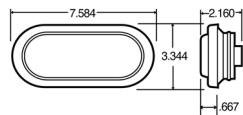

- Contains a heavy-duty dual filament bulb
- Mounts horizontally or vertically



Part Number	Lamp Connector	Lens Material	Volts	Amps Major/Minor
60283R	PL-3	PC	12	2.1/0.48



## 60<sup>®</sup> ECONOMY, INCANDESCENT, 1 BULB, 2"X 6" OVAL, GROMMET MOUNT, KIT



- Contains a heavy-duty dual filament bulb
- Mounts horizontally or vertically

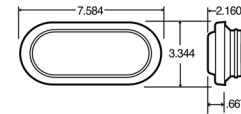

Part Number	Lamp Connector	Plug Side 1	Plug Side 2	Lens Material	Mount Color	Volts	Amps Major/Minor	Kit Includes/ Replacement Parts
60083R	PL-3	PL-3	Stripped End/ Ring Terminal	PC	Black	12	2.1/0.48	94993 plug, 60700 grommet, 60283R lamp

INCANDESCENT

60 ECONOMY

## SUPER 60<sup>®</sup>, INCANDESCENT, 1 BULB, 2"X 6" OVAL, GROMMET MOUNT



- Mounts horizontally or vertically
- Right angle plug assembly

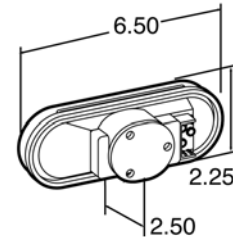

Part Number	Lamp Connector	Lens Material	Volts	Amps Major/Minor
60202R	PL-3	PC	12	2.1/0.48
60207R	PL-3	PC	24	0.93/0.34

INCANDESCENT

SUPER 60

## SUPER 60<sup>®</sup>, INCANDESCENT, 1 BULB, 2"X 6" OVAL, GROMMET MOUNT, KIT



- Mounts horizontally or vertically
- Right angle plug assembly

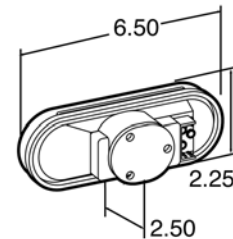

Part Number	Lamp Connector	Plug Side 1	Plug Side 2	Lens Material	Mount Color	Volts	Amps Major/Minor	Kit Includes/ Replacement Parts
60002R	PL-3	PL-3	Stripped End/ Ring Terminal	PC	Black	12	2.1/0.48	60700 grommet, 60202R lens, 94993 plug
60007R	PL-3	PL-3	Stripped End/ Ring Terminal	PC	Black	24	0.93/0.34	60083R grommet, 60207R lens

INCANDESCENT

SUPER 60

## 80 SERIES, INCANDESCENT, 1 BULB, 4" ROUND, FLANGE MOUNT, HARDWIRED

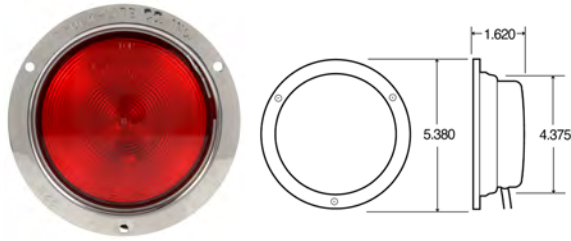

- Mounts flush to vehicle with recessed lens
- Features rubber housing for shock absorbcency



Part Number	Lamp Connector	Plug Side 1	Plug Side 2	Lens Material	Mount Color	Volts	Amps Major/Minor	Housing Material
80302R	Hardwired	Hardwired	Blunt Cut	AC	Black	12	2.25/1.44	Stainless Steel
80335R	Hardwired	Hardwired	Blunt Cut	PC	Silver	12	2.25/1.44	Unpolished Steel
80336R	Hardwired	Hardwired	Blunt Cut	PC	Silver	12	2.25/1.44	Polished Steel
80339R	Hardwired	Hardwired	Blunt Cut	PC	Black	12	2.25/1.44	

## 80 SERIES, INCANDESCENT, 1 BULB, 4" ROUND, FLANGE MOUNT, HARDWIRED, KIT

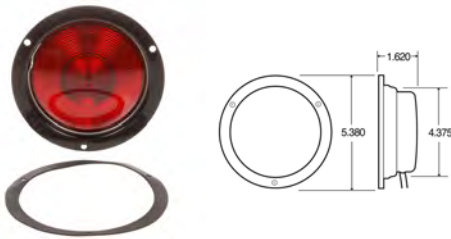

- Mounts flush to vehicle



Part Number	Lamp Connector	Plug Side 1	Plug Side 2	Lens Material	Mount Color	Volts	Amps Major/Minor	Kit Includes/ Replacement Parts
80334R	Hardwired	Hardwired	Blunt Cut	PC	Black	12	2.25/1.44	94993 plug, 60700 grommet, 60283R lamp

## 80 SERIES, INCANDESCENT, 1 BULB, 4" ROUND, STUD MOUNT, HARDWIRED

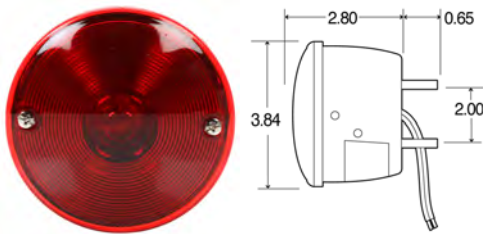

- Universal or 2 bolt mount 1/4" - 20
- Dual screws secure lens



Part Number	Lamp Connector	Plug Side 1	Plug Side 2	Lens Material	Lens Color	Mount Color	Mount Type	Volts	Amps Major/Minor
80461R	Hardwired	Hardwired	Stripped End	AC	Red/Clear	Black	Bracket	12	2.25/1.44
80462R	Hardwired	Hardwired	Stripped End	AC	Red	Black	Bracket	12	2.25/1.44
80463R	Hardwired	Hardwired	Stripped End	AC	Red/Clear	Black		12	2.25/1.44

## 90 SERIES, INCANDESCENT, 1 BULB, 7" ROUND, 4 SCREW



- Popular lamp on many school buses and emergency vehicles
- Recess mounts in a 5.25" diameter hole, 2.37" deep and uses four bolts on a 6.25" bolt circle

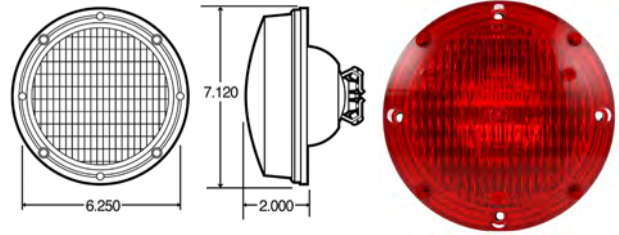

Part Number	Lamp Connector	Lens Material	Volts	Amps Major/Minor
90326R	Two Screw Terminal	AC	12	2.1/0.59

INCANDESCENT

90 SERIES

## 90 SERIES, INCANDESCENT, 1 BULB, 7" ROUND, 4 SCREW, HARDWIRED



- Popular lamp on many school buses and emergency vehicles
- Recess mounts in a 5.25" diameter hole, 2.37" deep and uses four bolts on a 6.25" bolt circle

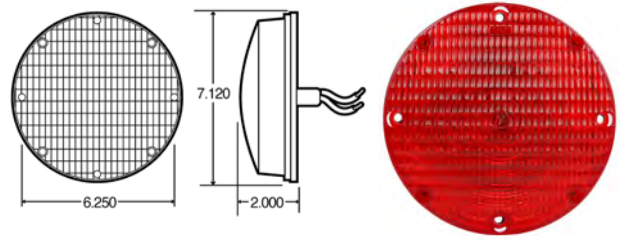

Part Number	Lamp Connector	Plug Side 1	Plug Side 2	Lens Material	Volts	Amps Major/Minor
90327R	Hardwired	Hardwired	Stripped End	AC	12	2.1/0.59

INCANDESCENT

90 SERIES

## Keep Your Connections Safe. Don't Forget Your Dielectric Gel.

Dielectric gel protects your lights by protecting the points of contact between elements of your lighting and harness system. Our dielectric compounds prevent arcing and corrosion and keep your lights performing as they should.

You can find our dielectric products on page 498



## 91<sup>®</sup> SERIES, INCANDESCENT, 1 BULB, 7" ROUND, 4 SCREW

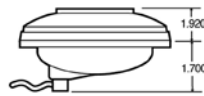
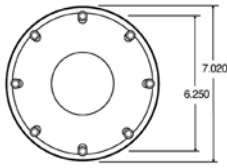

- Contains a heavy-duty shock mount
- 12 volt dual filament bulb
- Mounting gasket provides additional protection between lamp & body
- Mounts in a 5.375" hole



Part Number	Lamp Connector	Lens Material	Volts	Amps Major/Minor
91202R	PL-3	PC	12	2.1/0.48
91205R	PL-3	PC	24	0.93/0.34

## 91<sup>®</sup> SERIES, INCANDESCENT, 1 BULB, 7" ROUND, 4 SCREW, KIT

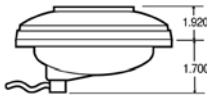
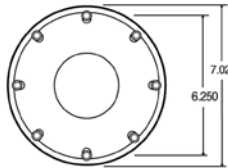

- Contains a heavy-duty shock mount
- 12 volt dual filament bulb
- Mounting gasket provides additional protection between lamp & body
- Mounts in a 5.375" hole



Part Number	Lamp Connector	Plug Side 1	Plug Side 2	Lens Material	Volts	Amps Major/Minor	Kit Includes/ Replacement Parts
91002R	PL-3	PL-3	Stripped End/Ring Terminal	PC	12	2.1/0.48	94993 plug, 91202R lamp

## 91<sup>®</sup> SERIES, INCANDESCENT, 1 BULB, 7" ROUND, 4 SCREW, HARDWIRED

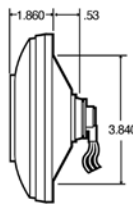
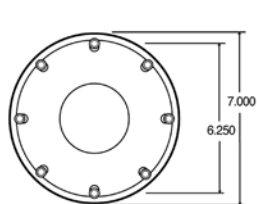

- Mounting gasket provides additional protection between lamp & body
- Mounts in a 3.84" hole



Part Number	Lamp Connector	Plug Side 1	Plug Side 2	Lens Material	Volts	Amps Major/Minor
91315R	Hardwired	Hardwired	Stripped End/Ring Terminal	PC	12	2.1/0.48

# INCANDESCENT, RECTANGULAR, 4 SCREW, 4" X 6", SOCKET ASSEMBLY



- Recess mounts using two screws at 3.0" centers and two screws at 4.2" centers

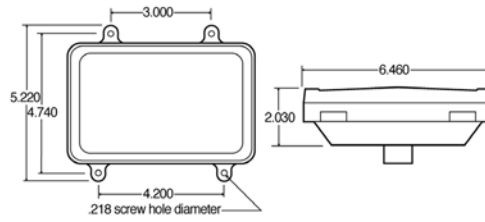

Part Number	Lamp Connector	Lens Material
07098	Socket Assembly	PC

INCANDESCENT

4 SCREW

# INCANDESCENT, 1 BULB, RECTANGULAR, 4 SCREW, 4" X 6"



- Recess mounts using two screws at 3.0" centers and two screws at 4.2" centers
- Watertight lamp mates with Packard connector
- 12v lamps mate with P.E. Connector 6288471

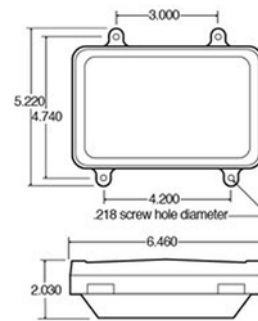

Part Number	Lamp Connector	Lens Material	Volts	Amps Major/Minor
07081	Blade Terminal	PC	12	2.1/0.48
07092	Blade Terminal	PC	12	2.1/0.48
07093	Blade Terminal	PC	24	3.1/1.48

INCANDESCENT

4 SCREW

LED

21 SERIES

## 21<sup>®</sup> SERIES, LED, 16 DIODES, 2"X6", BRACKET MOUNT, KIT

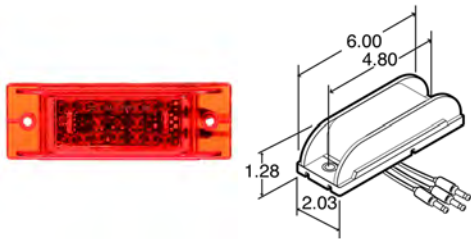

- Optional gaskets available to improve seal between lamp and body
- Electronics completely sealed in epoxy to resist corrosion and moisture
- Hardwired design eliminates pin corrosion
- Recommended for use in center high mounted stop lamp applications only



Part Number	Lamp Connector	Plug Side 1	Plug Side 2	Lens Color	Lens Material	Volts	Amps Major/Minor	Kit Includes/ Replacement Parts
21271R	Hardwired	Hardwired	.180 Bullet	Red	PC	12	0.14/0.04	

LED

60 SERIES

## 60<sup>®</sup> SERIES, LED, 26 DIODES, 2"X6", GROMMET MOUNT

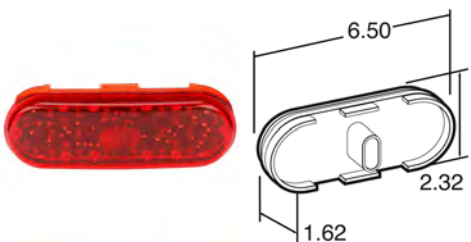

- Recommended for auxiliary brake light applications only
- Electronics completely sealed in epoxy to resist corrosion and moisture



Part Number	Lamp Connector	Lens Color	Lens Material	Mount Color	Volts	Amps Major/Minor
60260R	Fit 'N Forget S.S.	Red	PC		12	0.21/0.04

LED

60 SERIES

## 60<sup>®</sup> SERIES, LED, 26 DIODES, 2"X6", GROMMET MOUNT, KIT



- Recommended for auxiliary brake light applications only
- Electronics completely sealed in epoxy to resist corrosion and moisture



Part Number	Lamp Connector	Plug Side 1	Plug Side 2	Lens Color	Lens Material	Mount Color	Volts	Amps Major/Minor	Kit Includes/ Replacement Parts
60061R	Fit 'N Forget S.S.	Fit 'N Forget S.S.	Straight PL-2	Red	PC	Black	12	0.21/0.04	60260R lens, 60700 grommet, 94789 plug
60060R	Fit 'N Forget S.S.	Fit 'N Forget S.S.	Packard Connector 12020398	Red	PC	Black	12	0.21/0.04	45701 grommet, 60701 grommet

## 60<sup>®</sup> SERIES, LED, 26 DIODES, 2"X6", FLANGE MOUNT



- Recommended for auxiliary brake light applications only
- Electronics completely sealed in epoxy to resist corrosion and moisture

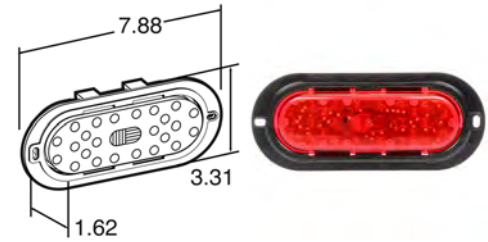

Part Number	Lamp Connector	Lens Color	Lens Material	Mount Color	Volts	Amps Major/Minor
60266R	Fit 'N Forget S.S.	Red	PC	Black	12	0.21/0.04
60262R	Fit 'N Forget S.S.	Red	PC	Gray	12	0.21/0.04

## 60<sup>®</sup> SERIES, LED, 26 DIODES, 2"X6", FLANGE MOUNT, KIT



- Recommended for auxiliary brake light applications only
- Electronics completely sealed in epoxy to resist corrosion and moisture



Part Number	Lamp Connector	Plug Side 1	Plug Side 2	Lens Color	Lens Material	Mount Color	Volts	Amps Major/Minor	Kit Includes/ Replacement Parts
60062R	Fit 'N Forget S.S.	Fit 'N Forget S.S.	Straight PL-2	Red	PC	Gray	12	0.21/0.04	60262R lens, 94789 plug

## LED, 9 DIODES, 1"X9", ADHESIVE MOUNT, KIT



- Slim lamp welcomes applications where space is at a premium
- Adhesive back adheres to mounting surface without the need for installation screws or brackets
- Peel-and-stick design makes for a tight, unbreakable seal
- DOT/SAE compliant
- 96" wire lead makes wiring easier
- Recommended for use in center high-mounted stop lamp applications only

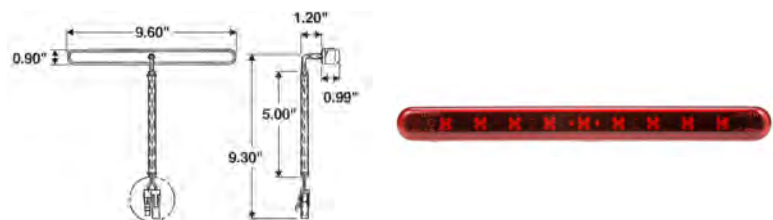

Part Number	Lamp Connector	Plug Side 1	Plug Side 2	Lens Color	Lens Material	Volts	Amps Major/Minor
92101	Hardwired	Hardwired	Packard Connector	Red	PC	12	0.23
92100	Hardwired	Hardwired	Stripped End	Red	PC	12	0.23

## 40<sup>®</sup> SERIES, INCANDESCENT, 1 BULB, 4", GROMMET MOUNT

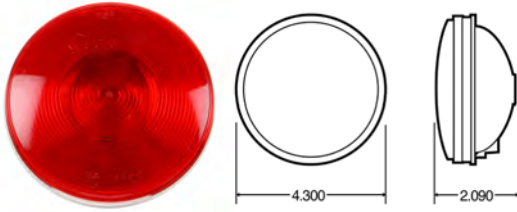

- Features high-mount stop function when center mounted on the top rear of the vehicle
- Heavy-duty, shock-mounted bulb
- Recommended for use in center high mount stop lamp applications only



Part Number	Lamp Connector	Lens Color	Lens Material	Mount Color	Volts	Amps Major/Minor
40247R	PL-3	Red	PC		12	1.44

## 45<sup>®</sup> SERIES, INCANDESCENT, 1 BULB, 3"X5", GROMMET MOUNT



- Features high mount stop function when center mounted on the top rear of the vehicle
- Heavy-duty, shock-mounted bulb
- Recommended for use in center high-mounted stop lamp applications

Part Number	Lamp Connector	Lens Color	Lens Material	Mount Color	Volts	Amps Major/Minor
45207R	PL-3	Red	PC	Black	12	1.44

## 45<sup>®</sup> SERIES, INCANDESCENT, 1 BULB, 3"X5", GROMMET MOUNT, KIT

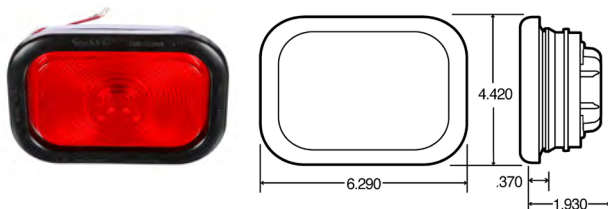

- Features high mount stop function when center mounted on the top rear of the vehicle
- Heavy-duty, shock-mounted bulb
- Recommended for use in center high-mounted stop lamp applications



Part Number	Lamp Connector	Plug Side 1	Plug Side 2	Lens Color	Lens Material	Mount Color	Volts	Amps Major/Minor	Kit Includes/ Replacement Parts
45007R	PL-2	PL-2	Stripped End/Ring Terminal	Red	PC	Black	12	1.44	45207R lens, 45700 grommet, 94992 plug

## 60<sup>®</sup> SERIES, INCANDESCENT, 1 BULB, 2"X6", GROMMET MOUNT

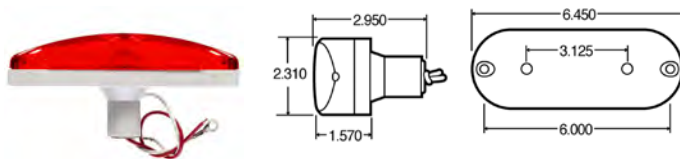

- Lamp may be either grommet or screw-mounted
- Mounts horizontally or vertically
- .250 Internal Knockout hole / 1.620 clearance hole
- Upgrade to Truck-Lite LED lighting systems using 60 Series LED products



Part Number	Lamp Connector	Plug Side 1	Plug Side 2	Lens Color	Lens Material	Volts	Amps Major/Minor
60303R	Hardwired	Hardwired	Stripped End/Ring Terminal	Red	PC	12	1.44



## 60<sup>®</sup> SERIES, INCANDESCENT, 1 BULB, 2"X6", GROMMET MOUNT, KIT



- Features high-mount stop function when center mounted on the top rear of the vehicle
- Single filament bayonet-base bulb
- Uses standard mounting holes & accessories
- Welded lamp grommet mounts

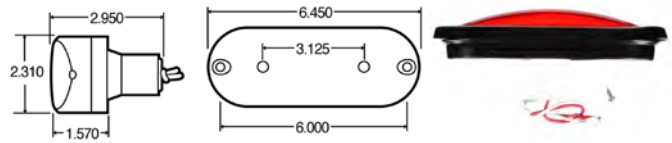

Part Number	Lamp Connector	Plug Side 1	Plug Side 2	Lens Color	Lens Material	Mount Color	Volts	Amps Major/Minor	Kit Includes
60324R	Hardwired	Hardwired	Stripped End Ring Terminal	Red	PC	Black	12	1.44	99011R lens, 60700 grommet, 60789 housing

INCANDESCENT

60 SERIES

## SUPER 60<sup>®</sup>, INCANDESCENT, 1 BULB, 2"X6", GROMMET MOUNT



- Features high-mount stop function when center mounted on the top rear of the vehicle
- Heavy-duty, shock-mounted bulb
- Recommended for auxiliary brake light applications only
- Upgrade to Truck-Lite LED Systems using part #60061R or 60260R

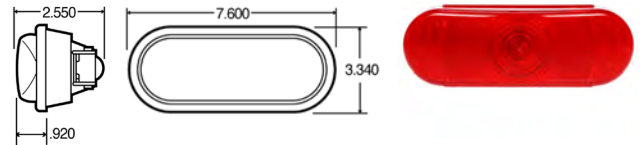

Part Number	Lamp Connector	Lens Color	Lens Material	Volts	Amps Major/Minor
60213R	PL-2	Red	PC	12	1.44

INCANDESCENT

60 SERIES

## SUPER 60<sup>®</sup>, INCANDESCENT, 1 BULB, 2"X6", GROMMET MOUNT, KIT



- Features high-mount stop function when center mounted on the top rear of the vehicle
- Heavy-duty shock-mounted bulb
- Recommended for auxiliary brake light applications only
- Upgrade to Truck-Lite LED Systems using part #60061R or 60260R

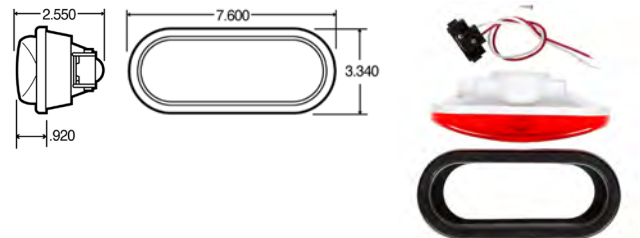

Part Number	Lamp Connector	Plug Side 1	Plug Side 2	Lens Color	Lens Material	Mount Color	Volts	Amps Major/Minor	Kit Includes
60013R	PL-2	Right Angle PL-2	Stripped End Ring Terminal	Red	PC	Black	12	1.44	60213R lens, 60700 grommet, 94992 plug

INCANDESCENT

SUPER 60

LED

SIGNAL-STAT

## SIGNAL-STAT, LED, 2 STUD MOUNT

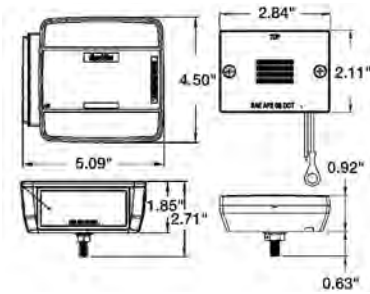

- Kit provides all legal lamps & reflective products for trailers less than 80" wide
- Popular on camping, motorcycle, horse & utility trailers



Part Number	Position	License Lamp	Lamp Connection	Plug Side 1	Plug Side 2	Lens Material	Volts	Amps Major/Minor
5055D	RH	No	Hardwired	Hardwired	Stripped End	AC	12	0.16/0.05
5056D	LH	No	Hardwired	Hardwired	Stripped End	AC	12	0.16/0.05

LED

SIGNAL-STAT

## SIGNAL-STAT, LED, 3 STUD MOUNT

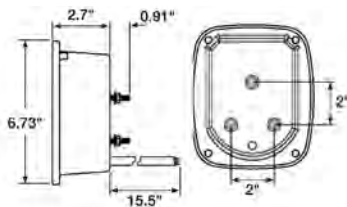

- Kit provides all legal lamps & reflective products for trailers less than 80" wide
- Popular on camping, motorcycle, horse & utility trailers



Part Number	Position	License Lamp	Lamp Connection	Plug Side 1	Plug Side 2	Lens Material	Volts	Amps Major/Minor
5070	LH	Yes	Hardwired	Hardwired	Stripped End	AC	12	0.14/0.06
5071	RH	No	Hardwired	Hardwired	Stripped End	AC	12	0.14/0.06
5072	LH	Yes	Hardwired	Hardwired	Packard Connector/ Ring Terminal	AC	12	0.14/0.06
5073	RH	No	Hardwired	Hardwired	Packard Connector/ Ring Terminal	AC	12	0.14/0.06

INCANDESCENT

FORD

## SIGNAL-STAT, LED, 3 STUD MOUNT, FORD

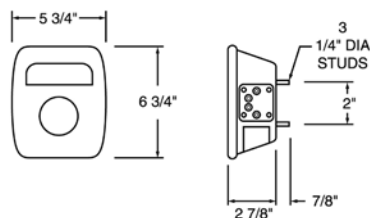

- Ford #D9HZ13405A and B (curbside)
- Ford #D9HZ13404A and B (roadside)
- Fits 1979 and later Ford models
- Freightliner #A06-13581-001 (curbside)
- Freightliner #A06-13581-000 (roadside)
- Includes junction box cover
- Rear lamp assembly combining stop, tail, turn, back-up and reflex reflector



Part Number	Position	License Lamp	Lamp Connection	Lens Material	Volts	Amps Major/Minor
4023	RH	Yes	Stud Terminal	PC	12	2.25/0.59
4024	LH	Yes	Stud Terminal	PC	12	2.25/0.59

## SIGNAL-STAT, LED, 2 STUD MOUNT, FORD/DODGE



- Dodge Truck #3895020 and 3895021
- Ford #DOTZ13404A, D3KZ13404A, D3TZ13403B, E2TB13404A and E2TB13405A
- Combination stop, tail, turn, back-up lamp with reflex reflector replaces Dodge and Ford truck models
- Universal rear pigtail connection
- Dual-optic lens and housing molded from tough polycarbonate with high heat and impact resistance

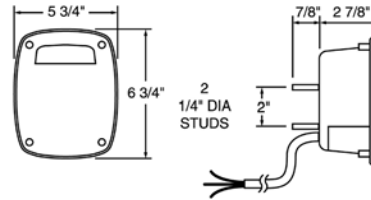

Part Number	Position	License Lamp	Lamp Connection	Plug Side 1	Plug Side 2	Lens Material	Volts	Amps Major/Minor
4028		Yes	Hardwired	Hardwired	Stripped End	PC	12	2.1/0.59

INCANDESCENT

FORD/DODGE

## SIGNAL-STAT, LED, 3 STUD MOUNT, FREIGHTLINER



- Ford #D9HZ13405A and B (curbside)
- Ford #D9HZ13404A and B (roadside)
- Fits 1979 and later Ford models
- Freightliner #A06-13581-001 (curbside)
- Freightliner #A06-13581-000 (roadside)
- Includes junction box cover
- Rear lamp assembly combining stop, tail, turn, back-up and reflex reflector

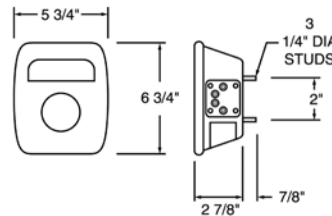

Part Number	Position	License Lamp	Lamp Connection	Lens Material	Volts	Amps Major/Minor
4023Y106	RH	Yes	Stud Terminal	Acrylic	12	2.25/0.59
4024Y106	LH	Yes	Stud Terminal	Acrylic	12	2.25/0.59

INCANDESCENT

FREIGHTLINER

## SIGNAL-STAT, LED, 3 STUD MOUNT, FREIGHTLINER/PETERBILT/GM



- 5024: Freightliner #681-544-0503 Peterbilt #16-06291 Volvo GM #8067855
- 5023: Freightliner #681-544-0503 Peterbilt #16-06291 Volvo GM #8067855

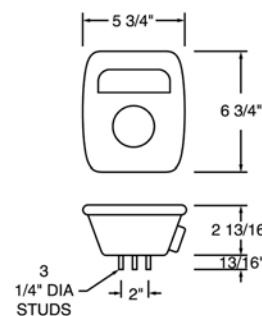

Part Number	Position	License Lamp	Lamp Connection	Lens Material	Volts	Amps Major/Minor
5023	LH	Yes	Packard Connector 12020116/ Packard Connector 12066271	PC	12	2.1/0.59
5024	RH	Yes	Packard Connector 12066271/ Packard Connector 12020116	PC	12	2.1/0.59

INCANDESCENT

FREIGHTLINER / PETERBILT / GM

## SIGNAL-STAT, LED, 3 STUD MOUNT, FREIGHTLINER/PETERBILT/GM/OSHKOSH

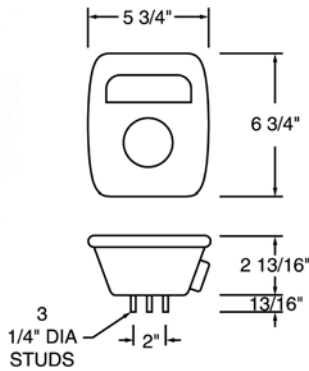

- 5013, 5013K: GM #15565731, 15574697, 15613943, 15684994 Oshkosh #2078210 Peterbilt #16-06160L
- 5014: GM #15565732, 15574696, 15613944, 15684995 Freightliner #681-544-04-03 Oshkosh #2078200 Peterbilt #16-06160R, 16-06292
- 5023Y102: Navistar #1661281C91



Part Number	Position	License Lamp	Lamp Connection	Plug Side 1	Plug Side 2	Lens Material	Volts	Amps Major/Minor
5013	LH	Yes	Packard Connector 12066271			PC	12	2.1/0.59
5013K	LH	Yes	Packard Connector	Packard Connector	Stripped End	PC	12	2.1/0.59
5014	RH	No	Packard Connector			PC	12	2.1/0.59
5014K	RH	No	Packard Connector	Packard Connector	Stripped End	PC	12	2.1/0.59

## SIGNAL-STAT, LED, 3 STUD MOUNT, NAVISTAR

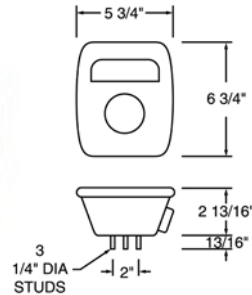

- 5023Y102: Navistar #1661281C91



Part Number	Position	License Lamp	Lamp Connection	Lens Material	Volts	Amps Major/Minor
5014Y102	RH	No	Packard Connector 12034047	PC	12	2.1/0.59
5023Y102	LH	Yes	Packard Connector 12020116/ Packard Connector 12034047	PC	12	2.1/0.59

INCANDESCENT

FREIGHTLINER / PETERBILT / GM / OSHKOSH

INCANDESCENT

NAVISTAR

## SIGNAL-STAT, LED, 3 STUD MOUNT, NAVISTAR



- Navistar #1661281C91
- Navistar #1661282C91
- RH lamp popular replacement for GM/IH OE #56139474, #15565732
- Combination stop, tail, turn, back-up and reflex reflector
- Dual-optic acrylic lens
- Permastat body provides impact resistance
- 5315Y101 has dual Metri-Pack connectors-one on either side of the lamp
- 5315Y101 uses #9470 main harness
- 5316Y101 uses #9469 jumper harness

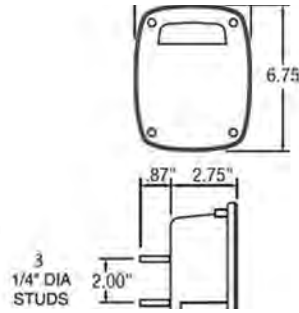

Part Number	Position	License Lamp	Lamp Connection	Lens Material	Volts	Amps Major/Minor
5315Y101	LH	Yes	Packard Connector	PC	12	2.1/0.59
5316Y101	RH	Yes	Packard Connector	PC	12	2.1/0.59

INCANDESCENT

NAVISTAR

## SIGNAL-STAT, LED, 3 STUD MOUNT, NAVISTAR



- Navistar #467707C91 and 424538C91 (LH).
- Navistar #467708C91 and 424539C91 (RH).
- Includes junction box cover.

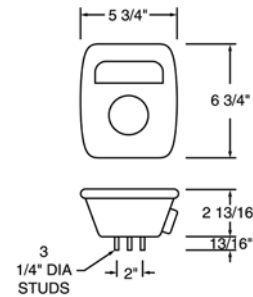

Part Number	Position	License Lamp	Lamp Connection	Lens Material	Volts	Amps Major/Minor
4015	LH	Yes	Blade Terminal	PC	12	2.1/0.59
4016	RH	Yes	Blade Terminal	PC	12	2.1/0.59

INCANDESCENT

NAVISTAR

## SIGNAL-STAT, LED, 3 STUD MOUNT, VOLVO



- 5014Y101: Volvo GM #8067856

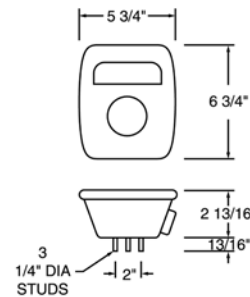

Part Number	Position	License Lamp	Lamp Connection	Lens Material	Volts	Amps Major/Minor
5014Y101	Volvo	No	Packard Connector 12066271	PC	12	2.1/0.59

INCANDESCENT

VOLVO

## INCANDESCENT, 2 STUD MOUNT

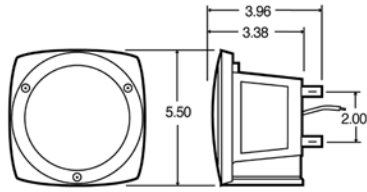

- Features reflectorized lens
- 2 bolt mounting
- Available with or without license window



Part Number	License Lamp	Lamp Connection	Plug Side 1	Plug Side 2	Lens Material	Volts	Amps Major/Minor
80322R	No	Hardwired	Hardwired	Blunt Cut	AC	12	2.1/0.27
80324R	Yes	Hardwired	Hardwired	Blunt Cut	AC	12	2.1/0.27

## SIGNAL-STAT, INCANDESCENT, 3 STUD MOUNT

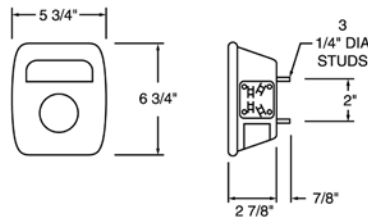

- Replaces all GM medium and heavy-duty 1972 to 1985
- Integral housing with 3 bolt mount
- Includes junction box cover



Part Number	Position	License Lamp	Lamp Connection	Lens Material	Volts	Amps Major/Minor
4017	LH	No	Screw Terminal	PC	12	2.1/0.59
4018	RH	Yes	Screw Terminal	PC	12	2.1/0.59

## SIGNAL-STAT, INCANDESCENT, 3 STUD MOUNT, HARDWIRED

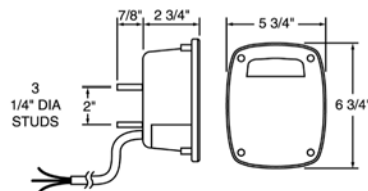

- Combination stop/turn/tail, back-up and reflex reflector
- Three bolt on 2" triangle
- Upgrade to LED Truck-Lite LED Products using #5070-#5073



Part Number	Packaging Type	License Lamp	Lamp Connection	Plug Side 1	Plug Side 2	Lens Material	Volts	Amps Major/Minor
4027	Standard	No	Hardwired	Hardwired	Stripped End	AC	12	2.1/0.59
4027D	Display	No	Hardwired	Hardwired	Stripped End	AC	12	2.1/0.59

# Looking for even more product information?

Visit [truck-lite.com](http://truck-lite.com)



**Powerful Search**



**360° Product Images**



**Easy-To-Find Replacement Parts**

# SIGNAL LIGHTING

## TURN SIGNAL LIGHTS

Pages 58-75

### LED

SERIES	COMMON SIZE	PAGES
Super 44®	4"	58-59
45® Series	3" x 5"	60-61
60® Series	2" x 6"	62-65
Super 60®	2" x 6"	66-67

### INCANDESCENT

SERIES	COMMON SIZE	PAGES
20 Series	2"	68
22® Series	2" x 6"	68
40® Series	7" x 13"	69
Super 40®	4"	69
45® Series	3" x 5"	70
Super 45®	3" x 5"	70
60® Series	2" x 6"	70-71
Super 60®	2" x 6"	71-72
Signal Stat Round	6"	72
Signal-Stat Oval	2" x 6"	72-73
Signal-Stat Square	7" x 7"	73
Round 1 Bulb	4"	74
Oval 1 Bulb	2" x 6"	74
Rectangular 1 Bulb	4" x 6"	75



## FRONT / PARK / TURN

Pages 76-92

### LED

SERIES	COMMON SIZE	PAGES
Super 44®	4"	76-79
60® Series	2" x 6"	80-81
91® Series	7"	82
Signal-Stat Round	4"	83
Signal-Stat Oval	2" x 6"	84

### INCANDESCENT

SERIES	COMMON SIZE	PAGES
40® Series	4"	86
40® Economy	4"	87
Super 45®	3" x 5"	88
60® Series	2" x 6"	88-89
Super 60®	2" x 6"	89-90
60® Economy	2" x 6"	90
91® Series	7"	91
7in 1 Bulb	7"	92
4in x 6in 1 Bulb	4" x 6"	92
6in x 10in 1 Bulb	6" x 10"	92
4in 1 Bulb	4"	92

## LONG LIFE VEHICLE LIGHTING (LLV)

Page 93

### LED

SERIES	PAGES
45® Series	93

### INCANDESCENT

SERIES	PAGES
60® Series	93

## PEDESTAL LIGHTS

Pages 94-105

### LED

SERIES	PAGES
Single Face	94
Dual Face	94-95

### INCANDESCENT

SERIES	PAGES
Signal Face Round	96-98
Dual Face Round	98-101
Signal Face Square	102
Dual Face Square	102-105







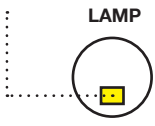
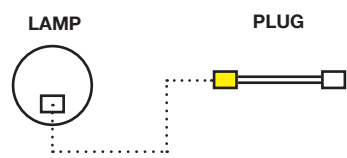
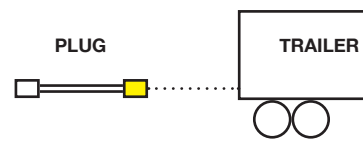

# Signal Lighting

**Truck-Lite's LED turn signal lighting is designed to exceed legal requirements and increase conspicuity when correctly mounted. With faster illumination time, other drivers on the road are able to react more quickly.**

<p><b>Shapes</b></p>	<p>Round, Oval, Rectangular</p>
<p><b>Mount Types</b></p>	<p>Grommet, Flange, Bracket, 2 Screw, 4 Screw, Adhesive, 2 Bolt, 1 Stud, 2 Stud</p>
<p><b>Connection Information</b></p> <p>When it comes to choosing the correct lamps for your truck or trailer, it's important to know the connection type on your vehicle's harness.</p> <p>If the harness connector type does not match your desired light (lamp connector), you will need a plug to complete the connection.</p>	<p><b>Lamp Connector</b></p> <p>The connector type located on the back of a lamp</p>  <p><b>Plug Side 1</b></p> <p>The connection between a plug and a lamp</p>  <p><b>Plug Side 2</b></p> <p>The connection between a plug and a trailer's harness</p> 

(800) 562-5012 | [truck-lite.com](http://truck-lite.com)

 <p><b>Manufacturing &amp; Quality</b></p>	 <p><b>Testing &amp; Safety</b></p>
<p>Truck-Lite’s LED marker/clearance lighting is built using premium materials and backed by industry-leading warranties. Designed to last the life of your vehicle, Truck-Lite’s solid-state construction and sealed circuitry mean that you can depend on your lighting to withstand shock, vibration, moisture and debris.</p>	<p>All Truck-Lite lamps are subjected to rigorous environmental, electrical and mechanical testing before they are validated and released to the market.</p> <p>All lamps comply with FMVSS/CMVSS-108, SAE and DOT standards when properly mounted.</p>
 <p><b>Performance &amp; Maintenance</b></p>	 <p><b>Customer Support</b></p>
<ul style="list-style-type: none"> <li>• Lower energy consumption, allowing more power for other vehicle requirements</li> <li>• Impact-resistant lenses and rugged housing protect against damage from even the toughest applications</li> <li>• Sealed electronics resist damage caused by moisture and corrosion</li> <li>• Reduced lighting costs associated with physical damage and heat entrapment</li> </ul>	<p><b>Customer Service</b></p> <p>(800) 562-5012 customerservice@truck-lite.com</p> <p><b>Technical Support</b></p> <p>(888) 562-5012 tltech@truck-lite.com</p> <p><b>Signal Lighting Warranties</b></p>   
<p>(800) 562-5012   truck-lite.com</p>	

# SUPER 44<sup>®</sup>, LED, 42 DIODES, 4" ROUND, GROMMET MOUNT

LED

SUPER 44

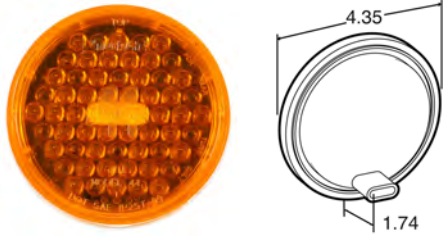

- Less current draw, resulting in increased battery and alternator life while allowing more power for other vehicle requirements
- Faster illumination offers significant safety benefit for following drivers to react more quickly, resulting in an average of 3' reaction time advantage for every 10 m.p.h.
- LEDs do not have a filament, therefore are not susceptible to damage from shock and vibration



Part Number	Lamp Connector	Lens Material	Volts	Amps Major/Minor
44201Y	Fit 'N Forget S.S.	PC	12	0.65/0.42
44881Y	Fit 'N Forget S.S.	AC	12	0.65/0.42

LED

SUPER 44

# SUPER 44<sup>®</sup>, LED, 42 DIODES, 4" ROUND, GROMMET MOUNT, KIT



- Less current draw, resulting in increased battery and alternator life while allowing more power for other vehicle requirements
- Faster illumination offers significant safety benefit for following drivers to react more quickly, resulting in an average of 3' reaction time advantage for every 10 m.p.h.
- LEDs do not have a filament, therefore are not susceptible to damage from shock and vibration



Part Number	Lamp Connector	Plug Side 1	Plug Side 2	Lens Material	Mount Color	Volts	Amps Major/Minor	Kit Includes/ Replacement Parts
44001Y	Fit 'N Forget S.S.	Fit 'N Forget S.S.	Straight Female PL-3	PC	Black	12	0.65/0.42	40700 grommet, 44201Y lamp

## Keep Your Connections Safe. Don't Forget Your Dielectric Gel.

Dielectric gel protects your lights by protecting the points of contact between elements of your lighting and harness system. Our dielectric compounds prevent arcing and corrosion and keep your lights performing as they should.

You can find our dielectric products on page 498



## SUPER 44<sup>®</sup>, LED, 42 DIODES, 4" ROUND, FLANGE MOUNT



- Less current draw, resulting in increased battery and alternator life while allowing more power for other vehicle requirements
- Faster illumination offers significant safety benefit for following drivers to react more quickly, resulting in an average of 3' reaction time advantage for every 10 m.p.h.
- LEDs do not have a filament, therefore are not susceptible to damage from shock and vibration

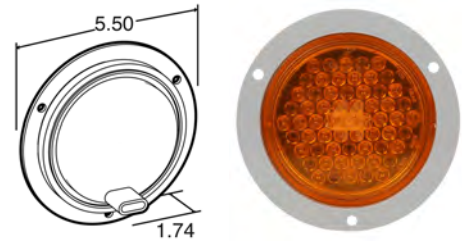

Part Number	Lamp Connector	Lens Material	Mount Color	Volts	Amps Major / Minor
44221Y	Fit 'N Forget S.S.	PC	Gray	12	0.65/0.42
44227Y	Fit 'N Forget S.S.	PC	Black	12	0.65/0.42
44231Y	Fit 'N Forget S.S.	PC	White	12	0.65/0.42
44276Y	Fit 'N Forget S.S.	PC	Black	24	0.26/0.02
44887Y	Fit 'N Forget S.S.	AC	Gray	12	0.65/0.42
44888Y	Fit 'N Forget S.S.	AC	Black	12	0.65/0.42

## SUPER 44<sup>®</sup>, LED, 42 DIODES, 4" ROUND, FLANGE MOUNT, KIT



- Less current draw, resulting in increased battery and alternator life while allowing more power for other vehicle requirements
- Faster illumination offers significant safety benefit for following drivers to react more quickly, resulting in an average of 3' reaction time advantage for every 10 m.p.h.
- LEDs do not have a filament, therefore are not susceptible to damage from shock and vibration

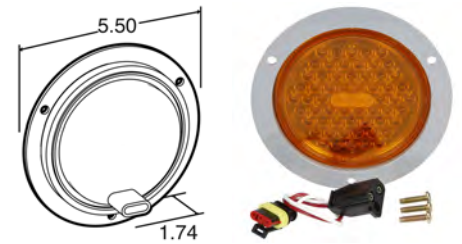

Part Number	Lamp Connector	Plug Side 1	Plug Side 2	Lens Material	Mount Color	Volts	Amps Major/Minor	Kit Includes/ Replacement Parts
44021Y	Fit 'N Forget S.S.	Fit 'N Forget S.S.	Straight Female PL-3	PC	Gray	12	0.65/0.42	94789 plug, 44221Y lamp
44027Y	Fit 'N Forget S.S.	Fit 'N Forget S.S.	Straight Female PL-3	PC	Black	12	0.65/0.42	94789 plug, 44221Y lamp

LED  
45 SERIES

## 45<sup>®</sup> SERIES, LED, 19 DIODES, 3"X 5" RECTANGULAR, GROMMET MOUNT

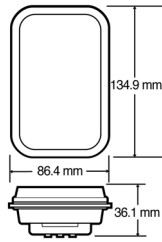

- OmniVolt<sup>®</sup> universal lighting products address increasing vehicle power demands by operating equally in electrical systems that range from 10 to 30 volts
- Lamps are hardwired with standard .180 molded bullet connectors
- Module receptacle wires with ring terminals available for retrofitting LED lamps to existing modules
- Direct pin-to-circuit board solders assure vibration resistant contacts
- Electronics completely sealed in epoxy to resist corrosion and moisture
- Low current draw, leaving more power for other vehicle requirements
- Sonically sealed lens and housing
- LEDs are less susceptible to shock and vibration
- Available in three versions - high intensity fog (red), direction indicator (yellow) and rear position (red)
- Approved to comply with ECE regulations for rear position/stop, direction indicator and rear fog functions



Part Number	Lamp Connector	Plug Side 1	Plug Side 2	Lens Material	Volts	Amps Major/Minor
45934Y	Hardwired	Hardwired	.180 Bullet	PC	12 24	0.31/0.03

LED  
45 SERIES

## 45<sup>®</sup> SERIES, LED, 70 DIODES, 3"X 5" RECTANGULAR, GROMMET MOUNT

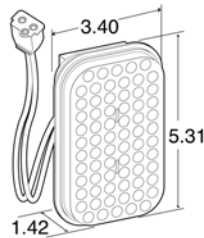
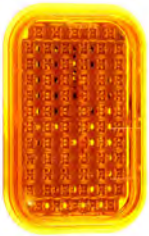

- Hardwired design
- Mounts horizontally or vertically
- Permanently affixed flange-mount version
- Standard connector makes retrofitting easy



Part Number	Lamp Connector	Plug Side 1	Plug Side 2	Lens Material	Volts	Amps Major/Minor
45251Y	Hardwired	Hardwired	Straight PL-3	PC	12	0.36/0.03
45263Y	Hardwired	Hardwired	Straight PL-3	PC	24	0.28/0.03

## 45<sup>®</sup> SERIES, LED, 70 DIODES, 3"X 5" RECTANGULAR, GROMMET MOUNT, KIT



- Hardwired design
- Mounts horizontally or vertically
- Permanently affixed flange-mount version
- Standard connector makes retrofitting easy

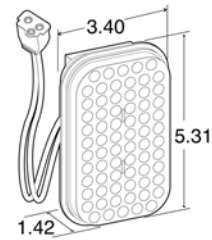

Part Number	Lamp Connector	Plug Side 1	Plug Side 2	Lens Material	Mount Color	Volts	Amps Major/Minor	Kit Includes/ Replacement Parts
45051Y	Hardwired	Hardwired	Straight PL-3	PC	Black	12	0.28/0.03	45700 grommet, 45251Y lamp
45063Y	Hardwired	Hardwired	Straight PL-3	PC	Black	24	0.28/0.03	94789 plug, 45263Y lamp

## 45<sup>®</sup> SERIES, LED, 70 DIODES, 3"X 5" RECTANGULAR, FLANGE MOUNT



- Hardwired design
- Mounts horizontally or vertically
- Permanently affixed flange-mount version
- Standard connector makes retrofitting easy

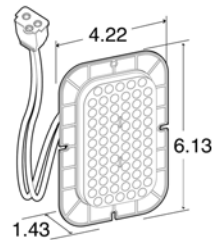

Part Number	Lamp Connector	Plug Side 1	Plug Side 2	Lens Material	Mount Color	Volts	Amps Major / Minor
45256Y	Hardwired	Hardwired	Straight PL-3	PC	Yellow	12	0.36/0.03

## Keep Your Connections Safe. Don't Forget Your Dielectric Gel.

Dielectric gel protects your lights by protecting the points of contact between elements of your lighting and harness system. Our dielectric compounds prevent arcing and corrosion and keep your lights performing as they should.

You can find our dielectric products on page 498



**60<sup>®</sup> SERIES, LED, 25 DIODES, 2"X 6" OVAL, GROMMET MOUNT**

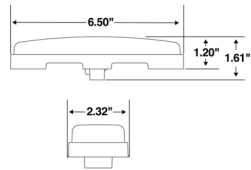

- 26 Diode for auxiliary turn lamps and 25 diode for sequential arrow lamps
- Auxiliary turn is a two-function lamp and complies with SAE 592E and 2042 on both functions
- Use part #60315Y for LED side turn applications SAE J2039
- Sequential arrow is to be used as an auxiliary lamp only and requires a 50% on time flasher, part #97231
- Not suitable for “stand alone” front or rear turn applications
- Electronics completely sealed in epoxy to resist corrosion and moisture



Part Number	Lamp Connector	Lens Material	Volts	Amps Major/Minor
60280Y	Fit 'N Forget S.S.	PC	12	0.12/0.08

**60<sup>®</sup> SERIES, LED, 25 DIODES, 2"X 6" OVAL, GROMMET MOUNT, KIT**

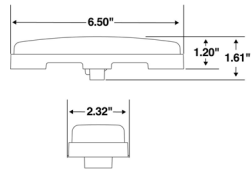

- 26 Diode for Auxiliary Turn Lamps and 25 Diode for Sequential Arrow Lamps
- Auxiliary turn is a two-function lamp and complies with SAE 592E and 2042 on both functions
- Use part #60315Y for LED side turn applications SAE J2039
- Sequential arrow is to be used as an auxiliary lamp only and requires a 50% on time flasher, part #97231
- Not suitable for “stand alone” front or rear turn applications
- Electronics completely sealed in epoxy to resist corrosion and moisture



Part Number	Lamp Connector	Plug Side 1	Plug Side 2	Lens Material	Mount Color	Volts	Amps Major/Minor	Kit Includes/ Replacement Parts
60080Y	Fit 'N Forget S.S.	Fit 'N Forget S.S.	Straight Female PL-3	PC	Black	12	0.12/0.08	60700 grommet, 94706 plug, 60280Y lamp

**Keep Your Connections Safe. Don't Forget Your Dielectric Gel.**

Dielectric gel protects your lights by protecting the points of contact between elements of your lighting and harness system. Our dielectric compounds prevent arcing and corrosion and keep your lights performing as they should.

You can find our dielectric products on page 498





## 60<sup>®</sup> SERIES, LED, 25 DIODES, 2" X 6" OVAL, FLANGE MOUNT



- 26 Diode for Auxiliary Turn Lamps and 25 Diode for Sequential Arrow Lamps
- Auxiliary turn is a two-function lamp and complies with SAE 592E and 2042 on both functions
- Use part #60315Y for LED side turn applications SAE J2039
- Sequential arrow is to be used as an auxiliary lamp only and requires a 50% on time flasher, part #97231
- Not suitable for "stand alone" front or rear turn applications
- Electronics completely sealed in epoxy to resist corrosion and moisture

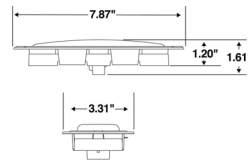

Part Number	Lamp Connector	Lens Material	Mount Color	Volts	Amps Major / Minor
60282Y	Fit 'N Forget S.S.	PC	Gray	12	0.12/0.08
60286Y	Fit 'N Forget S.S.	PC	Black	12	0.12/0.08

## 60<sup>®</sup> SERIES, LED, 25 DIODES, 2" X 6" OVAL, FLANGE MOUNT, KIT



- 26 Diode for Auxiliary Turn Lamps and 25 Diode for Sequential Arrow Lamps
- Auxiliary turn is a two-function lamp and complies with SAE 592E and 2042 on both functions
- Use part #60315Y for LED side turn applications SAE J2039
- Sequential arrow is to be used as an auxiliary lamp only and requires a 50% on time flasher, part #97231
- Not suitable for "stand alone" front or rear turn applications
- Electronics completely sealed in epoxy to resist corrosion and moisture

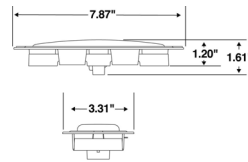

Part Number	Lamp Connector	Plug Side 1	Plug Side 2	Lens Material	Mount Color	Volts	Amps Major/Minor	Kit Includes/ Replacement Parts
60082Y	Fit 'N Forget S.S.	Fit 'N Forget S.S.	Straight Female PL-3	PC	Gray	12	0.12/0.08	94706 plug, 60282Y lamp

**60<sup>®</sup> SERIES, LED, 26 DIODES, 2" X 6" OVAL, GROMMET MOUNT**

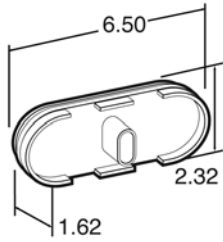

- Auxiliary turn is a two-function lamp and complies with SAE 592E and 2042 on both functions
- Use part #60315Y for LED side turn applications SAE J2039
- Sequential arrow is to be used as an auxiliary lamp only and requires a 50% on time flasher, part #97231
- Not suitable for “stand alone” front or rear turn applications
- Electronics completely sealed in epoxy to resist corrosion and moisture



Part Number	Lamp Connector	Lens Material	Volts	Amps Major/Minor
60255Y	Fit 'N Forget S.S.	PC	24	0.18/0.06
60275Y	Fit 'N Forget S.S.	PC	12	0.42/0.1
60891Y	Fit 'N Forget S.S.	AC	12	0.42/0.1

**60<sup>®</sup> SERIES, LED, 26 DIODES, 2" X 6" OVAL, GROMMET MOUNT, KIT**

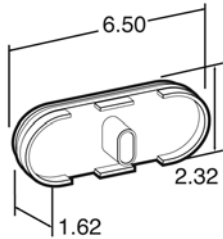

- Auxiliary turn is a two-function lamp and complies with SAE 592E and 2042 on both functions
- Use part #60315Y for LED side turn applications SAE J2039
- Sequential arrow is to be used as an auxiliary lamp only and requires a 50% on time flasher, part #97231
- Not suitable for “stand alone” front or rear turn applications
- Electronics completely sealed in epoxy to resist corrosion and moisture



Part Number	Lamp Connector	Plug Side 1	Plug Side 2	Lens Material	Mount Color	Volts	Amps Major/Minor	Kit Includes/ Replacement Parts
60075Y	Fit 'N Forget S.S.	Fit 'N Forget S.S.	Straight Female PL-3	PC	Black	12	0.42/0.1	60700 grommet, 94706 plug, 60275Y lamp,

LED

60 SERIES

LED

60 SERIES

## 60<sup>®</sup> SERIES, LED, 26 DIODES, 2"X 6" OVAL, FLANGE MOUNT



- Auxiliary turn is a two-function lamp and complies with SAE 592E and 2042 on both functions
- Not suitable for "stand alone" front or rear turn applications
- Electronics completely sealed in epoxy to resist corrosion and moisture

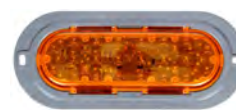
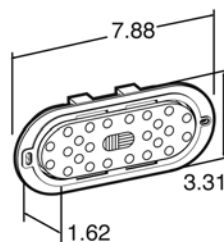

Part Number	Lamp Connector	Lens Material	Mount Color	Volts	Amps Major / Minor
60272Y	Fit 'N Forget S.S.	PC	Gray	12	0.42/0.1
60276Y	Fit 'N Forget S.S.	PC	Black	12	0.42/0.1
60872Y	Fit 'N Forget S.S.	AC	Gray	12	0.42/0.1

LED

60 SERIES

## 60<sup>®</sup> SERIES, LED, 26 DIODES, 2"X 6" OVAL, FLANGE MOUNT, KIT



- Auxiliary turn is a two-function lamp and complies with SAE 592E and 2042 on both functions
- Use part #60315Y for LED side turn applications SAE J2039
- Sequential arrow is to be used as an auxiliary lamp only and requires a 50% on time flasher, part #97231
- Not suitable for "stand alone" front or rear turn applications
- Electronics completely sealed in epoxy to resist corrosion and moisture

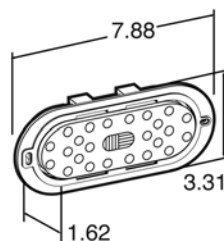

Part Number	Lamp Connector	Plug Side 1	Plug Side 2	Lens Material	Mount Color	Volts	Amps Major/Minor	Kit Includes/ Replacement Parts
60072Y	Fit 'N Forget S.S.	Fit 'N Forget S.S.	Straight Female PL-3	PC	Gray	12	0.42/0.08	94706 plug, 60272Y lamp

LED

60 SERIES

## Keep Your Connections Safe. Don't Forget Your Dielectric Gel.

Dielectric gel protects your lights by protecting the points of contact between elements of your lighting and harness system. Our dielectric compounds prevent arcing and corrosion and keep your lights performing as they should.

You can find our dielectric products on page 498



# SUPER 60®, LED, 11 DIODES, 2"X 6" OVAL, GROMMET MOUNT

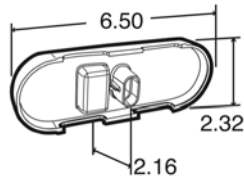

- U.S. Patent #7055996
- World's first LED side turn to surpass SAE J2039 standards in large vehicle applications
- Commonly mounted at "mid-point" on trailers or "no zone" areas on tractors
- LEDs do not have a filament, therefore are not susceptible to damage from shock and vibration
- Less current draw, resulting in increased battery and alternator life while allowing more power for other vehicle requirements
- Faster illumination offers significant safety benefit for following drivers to react quickly, resulting in an average of 3' reaction time advantage for every 10 m.p.h.



Part Number	Lamp Connector	Lens Material	Volts	Amps Major/Minor
60315Y	Fit 'N Forget S.S.	PC	12	0.52/0.08

# SUPER 60®, LED, 11 DIODES, 2"X 6" OVAL, GROMMET MOUNT, KIT

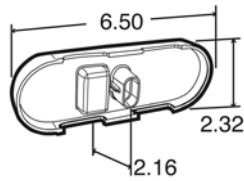

- U.S. Patent #7055996
- World's first LED side turn to surpass SAE J2039 standards in large vehicle applications
- Commonly mounted at "mid-point" on trailers or "no zone" areas on tractors
- LEDs do not have a filament, therefore are not susceptible to damage from shock and vibration
- Less current draw, resulting in increased battery and alternator life while allowing more power for other vehicle requirements
- Faster illumination offers significant safety benefit for following drivers to react quickly, resulting in an average of 3' reaction time advantage for every 10 m.p.h.



Part Number	Lamp Connector	Plug Side 1	Plug Side 2	Lens Material	Mount Color	Volts	Amps Major/Minor	Kit Includes/ Replacement Parts
60115Y	Fit 'N Forget S.S.	Fit 'N Forget S.S.	Straight Female PL-3	PC	Black	12	0.52/0.08	60700 grommet, 94706 plug, 60315Y lamp

LED

SUPER 60

LED

SUPER 60

## SUPER 60<sup>®</sup>, LED, 11 DIODES, 2"X 6" OVAL, FLANGE MOUNT



- U.S. Patent #7055996
- World's first LED side turn to surpass SAE J2039 standards in large vehicle applications
- Commonly mounted at "mid-point" on trailers or "no zone" areas on tractors
- LEDs do not have a filament, therefore are not susceptible to damage from shock and vibration
- Less current draw, resulting in increased battery and alternator life while allowing more power for other vehicle requirements
- Faster illumination offers significant safety benefit for following drivers to react quickly, resulting in an average of 3' reaction time advantage for every 10 m.p.h.

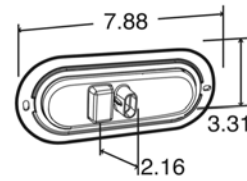

Part Number	Lamp Connector	Lens Material	Mount Color	Volts	Amps Major / Minor
60317Y	Fit 'N Forget S.S.	PC	Yellow	12	0.52/0.08

## SUPER 60<sup>®</sup>, LED, 11 DIODES, 2"X 6" OVAL, FLANGE MOUNT, KIT



- U.S. Patent #7055996
- World's first LED side turn to surpass SAE J2039 standards in large vehicle applications
- Commonly mounted at "mid-point" on trailers or "no zone" areas on tractors
- LEDs do not have a filament, therefore are not susceptible to damage from shock and vibration
- Less current draw, resulting in increased battery and alternator life while allowing more power for other vehicle requirements
- Faster illumination offers significant safety benefit for following drivers to react quickly, resulting in an average of 3' reaction time advantage for every 10 m.p.h.

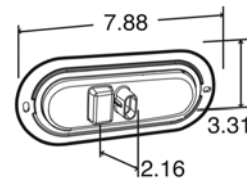

Part Number	Lamp Connector	Plug Side 1	Plug Side 2	Lens Material	Mount Color	Volts	Amps Major/Minor	Kit Includes/ Replacement Parts
60117Y	Fit 'N Forget S.S.	Fit 'N Forget S.S.	Straight Female PL-3	PC	Yellow	12	0.52/0.08	94706 plug, 60272Y lamp, 60317Y lamp

## 20 SERIES, 1 BULB, SIDE TURN, 2" ROUND, BRACKET MOUNT, HARDWIRED, KIT

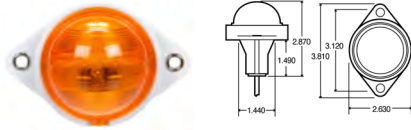

- Features snap-in lens with a 90° maximum edge visibility
- Features side turn function, with two versions also meeting marker/clearance requirements

Part Number	Lamp Connector	Plug Side 1	Plug Side 2	Lens Material	Lens Color	Mount Color	Volts	Amps Major/Minor	Kit Includes/ Replacement Parts
20301Y	Hardwired	Hardwired	Stripped End	PC	Yellow	White	12	2.1/0.5	99005Y lens
20304Y	Hardwired	Hardwired	Stripped End	PC	Yellow	White	12	2.1/0.5	99005Y lens
20309Y	Hardwired	Hardwired	.180 Bullet	PC	Yellow	Gray	12	2.1/0.5	20316Y
20310Y	Hardwired	Hardwired	Stripped End	PC	Yellow	Black	12	2.1/0.5	80604 bulb
20316Y	Hardwired	Hardwired	.180 Bullet	PC	Yellow	White	12	2.1/0.5	99005Y lens

## 22<sup>®</sup> SERIES, 1 BULB, SIDE TURN, 2"X 6" RECTANGULAR, 2 SCREW MOUNT



- Features dual contact marker/clearance and side turn or auxiliary turn functions
- Mounts on surface of vehicle or with "L" bracket
- Red lamp should be used for rear vehicle applications
- Yellow version exceeds SAEJ2039 side turn and marker standards

Part Number	Lamp Connector	Lens Material	Lens Color	Volts	Amps Major/Minor	Includes
22006R	PL-3	PC	Red	12	2.1/0.49	gasket
22006Y	PL-3	PC	Yellow	12	2.1/0.49	gasket
22016Y	PL-3	PC	Yellow	12	2.1/0.49	black base
22202R	PL-3	PC	Red	12	2.1/0.49	
22202Y	PL-3	PC	Yellow	12	2.1/0.49	

## 22<sup>®</sup> SERIES, 1 BULB, SIDE TURN, 2"X 6" RECTANGULAR, 2 SCREW MOUNT, KIT



- Features dual contact marker/clearance and side turn or auxiliary turn functions
- Mounts on surface of vehicle or with "L" bracket

Part Number	Lamp Connector	Plug Side 1	Plug Side 2	Lens Material	Lens Color	Volts	Amps Major/Minor	Kit Includes/ Replacement Parts
22002R	PL-3	Right Angle PL-3	Stripped End/ Ring Terminal	PC	Red	12	2.1/0.49	22202R light, 94993 plug
22002Y	PL-3	Right Angle PL-3	Stripped End/ Ring Terminal	PC	Yellow	12	2.1/0.49	22202Y light, 94993 plug
22004R	PL-3	Right Angle PL-3	Stripped End/ Ring Terminal	PC	Red	12	2.1/0.49	22006R light, 94993 plug
22004Y	PL-3	Right Angle PL-3	Stripped End/ Ring Terminal	PC	Yellow	12	2.1/0.49	22006Y light, 94993 plug

INCANDESCENT

20 SERIES

INCANDESCENT

22 SERIES

INCANDESCENT

22 SERIES

## 40<sup>®</sup> SERIES, 2 BULB, AUXILIARY, 7"X 13" RECTANGULAR, BRACKET MOUNT



- Features large outer lens for greater visibility
- Includes slotted bracket for ease of installation and adjustment
- Available with enclosed housing for extra protection
- Use part numbers 40812 and 40830 for LED versions

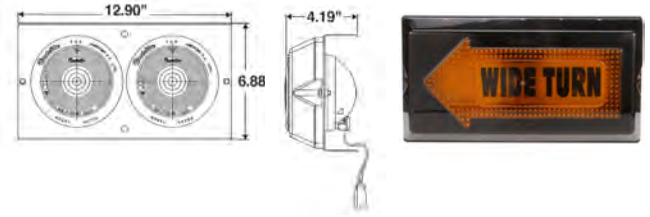

Part Number	Position	Lamp Connector	Plug Side 1	Plug Side 2	Lens Material	Lens Color	Mount Color	Volts	Amps Major/Minor
40802	LH	PL-3	Right Angle PL-3	Straight Female PL-3	PC	Yellow	Black	12	2.1/0.5
40803	RH	PL-3	Right Angle PL-3	Straight Female PL-3	PC	Yellow	Black	12	2.1/0.5
40804	LH	PL-2	PL-2	Ring Terminal	PC	Yellow	Black	12	2.1/0.5
40805	RH	PL-2	PL-2	Ring Terminal	PC	Yellow	Black	12	2.1/0.5

INCANDESCENT

40 SERIES

## SUPER 40<sup>®</sup>, 1 BULB, REAR TURN, 4" ROUND, GROMMET MOUNT



- Uses standard mounting holes and accessories
- Flush mount grommets are designed for mounting in a 4-1/2" hole
- Uniquely designed shock-mount extends lamp life
- Uses standard mounting holes and accessories
- Upgrade to Truck-Lite LED lighting systems using Super 44 Products



Part Number	Lamp Connector	Lens Material	Lens Color	Volts	Amps Major/Minor
40241R	PL-3	PC	Red	12	2.1/0.5
40241Y	PL-3	PC	Yellow	12	2.1/0.5

INCANDESCENT

SUPER 40

## SUPER 40<sup>®</sup>, 1 BULB, REAR/FRONT TURN, 4" ROUND, GROMMET MOUNT, KIT



- Uses standard mounting holes and accessories
- Flush mount grommets are designed for mounting in a 4-1/2" hole
- Uniquely designed shock-mount extends lamp life
- Uses standard mounting holes and accessories
- Upgrade to Truck-Lite LED lighting systems using Super 44 Products



Part Number	Lamp Connector	Lens Material	Lens Color	Mount Color	Volts	Amps Major/Minor	Kit Includes/ Replacement Parts
40041Y	PL-3	PC	Yellow	Black	12	2.1/0.5	40241Y lamp, 40700 grommet, 94992 plug

INCANDESCENT

SUPER 40

## 45<sup>®</sup> SERIES, 1 BULB, REAR TURN, 3"X 5" RECTANGULAR, GROMMET MOUNT, KIT

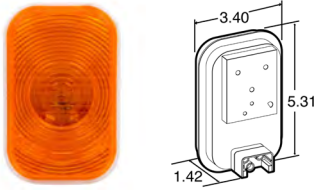

- Direct replacement for approved lamps on United States Postal Service L.L.V. (Long Life Vehicle)
- Designed for mounting on a 7 - 11 degree rollback from the vertical plane
- Three versions, each features turn and hazard functions, stop and tail functions, or back-up functions



Part Number	Lamp Connector	Plug Side 1	Plug Side 2	Lens Material	Lens Color	Mount Color	Volts	Amps Major/Minor
45021Y	PL-3	Right Angle PL-3	Packard Connector	PC	Yellow	Black	12	2.1/0.58

## SUPER 45<sup>®</sup>, 1 BULB, REAR TURN, 3"X 5" RECTANGULAR, GROMMET MOUNT, KIT



- Heavy duty bulb for longer life
- Mount horizontally or vertically
- Upgrade to Truck-Lite LED Lighting Systems using 45 Series Products



Part Number	Lamp Connector	Plug Side 1	Plug Side 2	Lens Material	Lens Color	Mount Color	Volts	Amps Major/Minor
45001R	PL-2	Right Angle PL-2	Stripped End/Ring Terminal	PC	Red	Black	12	2.1/0.58
45001Y	PL-2	Right Angle PL-2	Stripped End/Ring Terminal	PC	Yellow	Black	12	2.1/0.58

## 60<sup>®</sup> SERIES, 1 BULB, SIDE TURN, 2"X 6" OVAL, GROMMET MOUNT

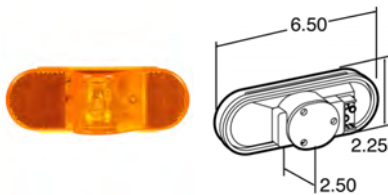

- Features side indicator, marker/clearance and reflector functions
- Narrow width facilitates horizontal mounting
- Red lamp should be used only for rear vehicle applications
- Meets SAE J2039 recommendation for side turn signal
- Upgrade to Truck-Lite LED lighting systems using Super 60 LED products



Part Number	Lamp Connector	Lens Material	Lens Color	Volts	Amps Major/Minor
60215Y	PL-3	PC	Yellow	12	2.1/0.49
60217Y	PL-3	PC	Yellow	24	1/0.36

INCANDESCENT

45 SERIES

INCANDESCENT

SUPER 45

INCANDESCENT

60 SERIES



## 60<sup>®</sup> SERIES, 1 BULB, SIDE TURN, 2"X 6" OVAL, GROMMET MOUNT, KIT



- Features side indicator, marker/clearance and reflector functions
- Narrow width facilitates horizontal mounting
- Red lamp should be used only for rear vehicle applications
- Meets SAE J2039 recommendation for side turn signal
- Upgrade to Truck-Lite LED lighting systems using Super 60 LED products

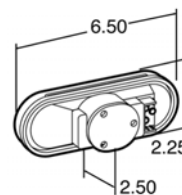

Part Number	Lamp Connector	Plug Side 1	Plug Side 2	Lens Material	Lens Color	Mount Color	Volts	Amps Major/Minor	Kit Includes/ Replacement Parts
60015R	PL-3	Right Angle PL-3	Stripped End/ Ring Terminal	PC	Red	Black	12	2.1/0.49	60215R, 94993 plug, 60700 grommet
60015Y	PL-3	Right Angle PL-3	Stripped End/ Ring Terminal	PC	Yellow	Black	12	2.1/0.49	60215Y, 94993 plug, 60700 grommet

INCANDESCENT

60 SERIES

## 60<sup>®</sup> SERIES, 1 BULB, REAR TURN, 2"X 6" OVAL, GROMMET MOUNT, KIT



- Features side indicator, marker/clearance and reflector functions
- Narrow width facilitates horizontal mounting
- Red lamp should be used only for rear vehicle applications
- Meets SAE J2039 recommendation for side turn signal
- Upgrade to Truck-Lite LED lighting systems using Super 60 LED products

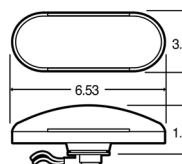

Part Number	Lamp Connector	Plug Side 1	Plug Side 2	Lens Material	Lens Color	Mount Color	Volts	Amps Major/Minor
60344R	Socket Assembly	Socket Assembly	Stripped End/ Ring Terminal	PC	Red	Black	12	2.1/0.59
60344Y	Socket Assembly	Socket Assembly	Stripped End/ Ring Terminal	PC	Yellow	Black	12	2.1/0.59

INCANDESCENT

60 SERIES

## SUPER 60<sup>®</sup>, 1 BULB, REAR TURN, 2"X 6" OVAL, GROMMET MOUNT



- Mounts horizontally or vertically
- Upgrade to Truck-Lite LED lighting systems using 60 Series LED products

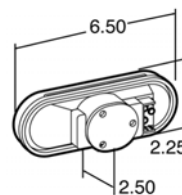

Part Number	Lamp Connector	Lens Material	Lens Color	Volts	Amps Major/Minor
60201R	PL-3	PC	Red	12	2.1/0.49
60201Y	PL-3	PC	Yellow	12	2.1/0.49

INCANDESCENT

SUPER 60

## SUPER 60®, 1 BULB, AUXILIARY, 2"X 6" OVAL, GROMMET MOUNT, KIT

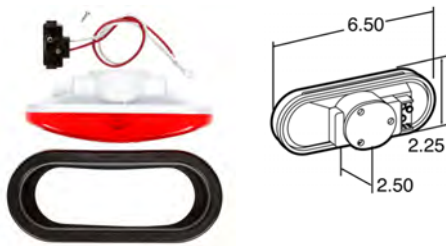

- Features side indicator, marker/clearance and reflector functions
- Narrow width facilitates horizontal mounting
- Red lamp should be used only for rear vehicle applications
- Meets SAE J2039 recommendation for side turn signal
- Upgrade to Truck-Lite LED lighting systems using Super 60 LED products



Part Number	Lamp Connector	Plug Side 1	Plug Side 2	Lens Material	Lens Color	Mount Color	Volts	Amps Major/Minor	Kit Includes/ Replacement Parts
60001R	PL-2	Right Angle PL-2	Stripped End/ Ring Terminal	PC	Red	Black	12	2.1/0.49	60201R, 94992 plug, 60700 grommet
60001Y	PL-2	Right Angle PL-2	Stripped End/ Ring Terminal	PC	Yellow	Black	12	2.1/0.49	60201Y, 94992 plug, 60700 grommet

## SIGNAL-STAT, 1 BULB, REAR TURN, 6" ROUND, 4 SCREW MOUNT

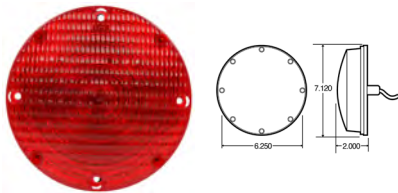

- Requires a 1" diameter hole, 1" deep
- Popular lamp on buses and emergency vehicles
- Replaces Signal-Stat 6505/A



Part Number	Lamp Connector	Plug Side 1	Plug Side 2	Lens Material	Lens Color	Volts	Amps Major/Minor
6503	Hardwired	Hardwired	Stripped End	Acrylic	Red	12	2.1/0.17

## SIGNAL-STAT, 1 BULB, AUXILIARY, 2"X 6" OVAL, 2 SCREW MOUNT

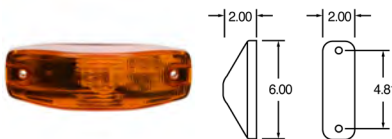

- Red for supplementary stop light or turn signal
- Yellow for side turn signal and marker lamp
- Exceeds requirements for mid-trailer turn signal lamps
- For Navistar #1677711C91 replacement use Signal Stat #4091A



Part Number	Lamp Connector	Lens Material	Lens Color	Volts	Amps Major/Minor
4091	Female TA-1415	PC	Red	12	2.1/0.5
4091A	Female TA-1415	PC	Yellow	12	2.1/0.5
4093	Female TA-1415	PC	Red	12	2.1/0.5
4093A	Female TA-1415	PC	Yellow	12	2.1/0.5

INCANDESCENT

SUPER 60

INCANDESCENT

SIGNAL-STAT

INCANDESCENT

SIGNAL-STAT

# SIGNAL-STAT, 1 BULB, AUXILIARY, 2"X 6" OVAL, 2 SCREW MOUNT, KIT



- Red for supplementary stop light or turn signal
- Yellow for side turn signal and marker lamp
- Exceeds requirements for mid-trailer turn signal lamps
- For Navistar #1677711C91 replacement use Signal Stat #4091A

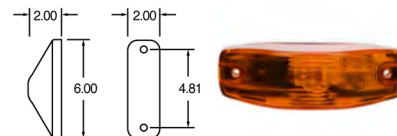

Part Number	Lamp Connector	Plug Side 1	Plug Side 2	Lens Material	Lens Color	Volts	Amps Major/Minor	Kit Includes/ Replacement Parts
4094	Female TA-1415	Right Angle PL-3	.180 Bullet  Ring Terminal	PC	Red	12	2.1/0.5	SS4091 light, 9463 plug
4094A	Female TA-1415	Right Angle PL-3	.180 Bullet  Ring Terminal	PC	Yellow	12	2.1/0.5	SS4091A light, 9463 plug
4095	Female TA-1415	Right Angle PL-3	.180 Bullet  Ring Terminal	PC	Red	12	2.1/0.5	SS4093 light, 9463 plug
4095A	Female TA-1415	Right Angle PL-3	.180 Bullet/ Ring Terminal	PC	Yellow	12	2.1/0.5	SS4093 light, 9463 plug

# SIGNAL-STAT, 1 BULB, AUXILIARY, 7"X 7" SQUARE, 2 SCREW MOUNT

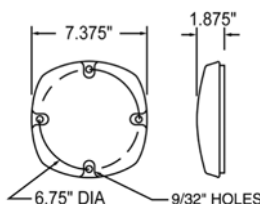

ARROW LENS

- Popular school bus signal lamps
- Rimless lens construction
- Positive seal prevents leaking and eliminates cracked lenses
- Double-optic lens covers black enameled steel housing

Part Number	Lamp Connector	Plug Side 1	Plug Side 2	Lens Material	Lens Color	Volts	Amps Major/Minor	Arrow Lens
6500	Hardwired	Hardwired	Stripped End	AC	Red	12	2.1/0.5	No
6500A	Hardwired	Hardwired	Stripped End	AC	Amber	12	2.1/0.5	No
6501	Hardwired	Hardwired	Stripped End	AC	Red	12	2.1/0.5	Yes
6501A	Hardwired	Hardwired	Stripped End	AC	Amber	12	2.1/0.5	Yes
6503A	Hardwired	Hardwired	Stripped End	AC	Amber	12	2.1/0.5	No

## ROUND, 1 BULB, REAR TURN, 4" ROUND, FLANGE MOUNT



- Flush mount lamp with recessed lens
- Stainless steel retaining ring holds lens in place
- Part #81301R shown above
- Upgrade to Truck-Lite LED lighting systems using Super 44 Rear Turn Products



Part Number	Lamp Connector	Plug Side 1	Plug Side 2	Lens Material	Lens Color	Mount Color	Volts	Amps Major/Minor
81300R	Hardwired	Hardwired	Blunt Cut	PC	Red	Black	12	2.1/0.5
81300Y	Hardwired	Hardwired	Blunt Cut	PC	Yellow	Black	12	2.1/0.5

## OVAL, 1 BULB, SIDE TURN, 2"X 6" OVAL, GROMMET MOUNT

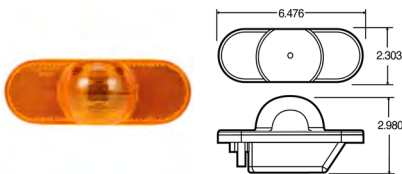

- Male pin connections
- Features side indicator, marker/clearance and reflector functions
- Narrow width facilitates horizontal mounting
- Meets SAE J2039 recommendation for side turn signal
- Replaces Grote #52533
- Upgrade to Truck-Lite LED lighting systems using Super 60 LED lamps



Part Number	Lamp Connector	Lens Material	Lens Color	Volts	Amps Major/Minor
69202Y	PL-3	PC	Yellow	12	2.1/0.5

## OVAL, 1 BULB, SIDE TURN, 2"X 6" OVAL, GROMMET MOUNT, KIT

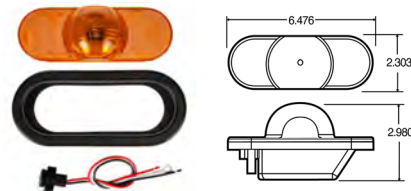

- Male pin connections
- Features side indicator, marker/clearance and reflector functions
- Narrow width facilitates horizontal mounting
- Meets SAE J2039 recommendation for side turn signal
- Replaces Grote #52533
- Upgrade to Truck-Lite LED lighting systems using Super 60 LED lamps



Part Number	Lamp Connector	Plug Side 1	Plug Side 2	Lens Material	Lens Color	Mount Color	Volts	Amps Major/Minor	Kit Includes/ Replacement Parts
69002Y	PL-3	Female PL-3	Stripped End/ Ring Terminal	PC	Yellow	Black	12	2.1/0.5	69202Y lamp, 96107 plug, 60700 grommet

INCANDESCENT

ROUND 1 BULB

INCANDESCENT

OVAL 1 BULB

INCANDESCENT

OVAL 1 BULB

# RECTANGULAR, 1 BULB, REAR TURN, 4"X 6" RECTANGULAR, 4 SCREW MOUNT, SOCKET ASSEMBLY



- Polycarbonate lens and housing are sealed
- Bulb socket cams-in for ease of repair/ replacement (sold separately)
- Recess mounts using two screws at 3.0" centers and two screws at 4.2" centers

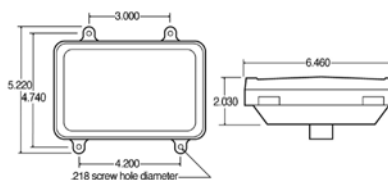

Part Number	Lamp Connector	Lens Material	Lens Color
7097	Socket Assembly	PC	Yellow

INCANDESCENT

RECTANGULAR 1 BULB

# Looking for even more product information?

Visit [truck-lite.com](http://truck-lite.com)



Powerful Search Function



360° Product Images



Easy-To-Find Replacement Parts

## SUPER 44<sup>®</sup>, LED, 6 DIODES, 4" ROUND, GROMMET MOUNT

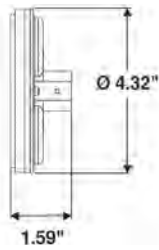

- Offers the same safety and low maintenance benefits of existing F/P/T lights with fewer diodes
- Uses less current draw, resulting in increased battery & alternator life while allowing more power for other vehicle requirements
- LEDs do not have a filament, therefore are not susceptible to damage from shock and vibration
- Flange mounts are permanently affixed to light
- Designed to comply with FMVSS 108



Part Number	Lamp Connection	Lens Material	Lens Color	Volts	Amps Major/Minor	Diamond Shell
44294Y	Fit 'N Forget S.S.	PC	Yellow	12	0.03/0.59	No
44291Y	Fit 'N Forget S.S.	AC	Yellow	12	0.03/0.59	Yes

## SUPER 44<sup>®</sup>, LED, 6 DIODES, 4" ROUND, GROMMET MOUNT, KIT

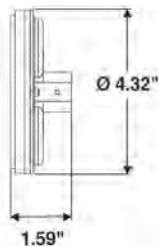

- Offers the same safety and low maintenance benefits of existing F/P/T lights with fewer diodes
- Uses less current draw, resulting in increased battery & alternator life while allowing more power for other vehicle requirements
- LEDs do not have a filament, therefore are not susceptible to damage from shock and vibration
- Flange mounts are permanently affixed to light
- Designed to comply with FMVSS 108



Part Number	Lamp Connection	Plug Side 1	Plug Side 2	Lens Material	Lens Color	Mount/Trim Color	Volts	Amps Major/Minor	Diamond Shell	Kit Includes/Replacement Parts
44094Y	Fit 'N Forget S.S.	Fit 'N Forget S.S.	Female PL-3	PC	Yellow	Black	12	0.03/0.59	No	44294Y light, 40700 grommet, 94706 plug
44091Y	Fit 'N Forget S.S.	Fit 'N Forget S.S.	Female PL-3	AC	Yellow	Black	12	0.03/0.59	Yes	44291Y light, 40700 grommet, 94760 plug

## Keep Your Connections Safe. Don't Forget Your Dielectric Gel.

Dielectric gel protects your lights by protecting the points of contact between elements of your lighting and harness system. Our dielectric compounds prevent arcing and corrosion and keep your lights performing as they should.

You can find our dielectric products on page 498



## SUPER 44<sup>®</sup>, LED, 6 DIODES, 4" ROUND, FLANGE MOUNT



- Offers the same safety and low maintenance benefits of existing F/P/T lights with fewer diodes
- Uses less current draw, resulting in increased battery & alternator life while allowing more power for other vehicle requirements
- LEDs do not have a filament, therefore are not susceptible to damage from shock and vibration
- Flange mounts are permanently affixed to light
- Designed to comply with FMVSS 108

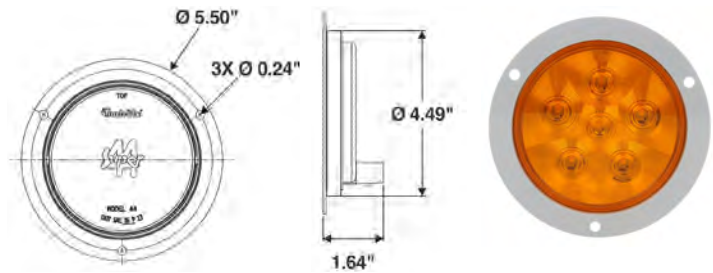

Part Number	Lamp Connection	Lens Material	Lens Color	Mount/Trim Color	Volts	Amps Major/Minor	Diamond Shell
44292Y	Fit 'N Forget S.S.	PC	Yellow	Black	12	0.03/0.59	No
44293Y	Fit 'N Forget S.S.	PC	Yellow	White	12	0.03/0.59	No
44295Y	Fit 'N Forget S.S.	PC	Yellow	Gray	12	0.03/0.59	No

## SUPER 44<sup>®</sup>, LED, 6 DIODES, 4" ROUND, FLANGE MOUNT, KIT



- Offers the same safety and low maintenance benefits of existing F/P/T lights with fewer diodes
- Uses less current draw, resulting in increased battery & alternator life while allowing more power for other vehicle requirements
- LEDs do not have a filament, therefore are not susceptible to damage from shock and vibration
- Flange mounts are permanently affixed to light
- Designed to comply with FMVSS 108

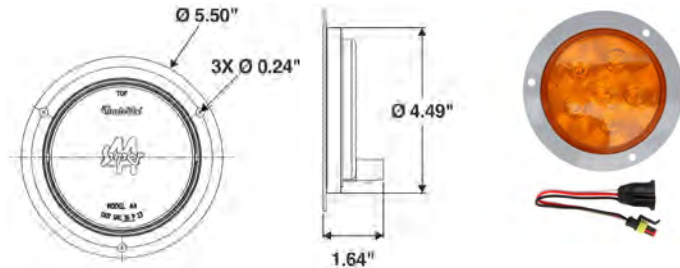

Part Number	Lamp Connection	Plug Side 1	Plug Side 2	Lens Material	Lens Color	Mount/Trim Color	Volts	Amps Major/Minor	Diamond Shell	Kit Includes/Replacement Parts
44092Y	Fit 'N Forget S.S.	Fit 'N Forget S.S.	Female PL-3	PC	Yellow	Black	12	0.03/0.59	No	44292Y light, 94706 plug
44093Y	Fit 'N Forget S.S.	Fit 'N Forget S.S.	Female PL-3	PC	Yellow	White	12	0.03/0.59	No	44293Y light, 94706 plug
44095Y	Fit 'N Forget S.S.	Fit 'N Forget S.S.	Female PL-3	PC	Yellow	Gray	12	0.03/0.59	No	44295Y light, 94706 plug

## SUPER 44® , LED, 60 DIODES, 4" ROUND, GROMMET MOUNT

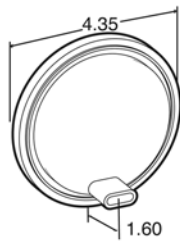

- LEDs do not have a filament, therefore are not susceptible to damage from shock and vibration
- Less current draw, resulting in increased battery and alternator life while allowing more power for other vehicle requirements
- Front, Park and Turn lamps meet stringent SAE and NHTSA requirements



Part Number	Lamp Connection	Lens Material	Lens Color	Mount/Trim Color	Volts	Amps Major/Minor	Diamond Shell
44203Y	Fit 'N Forget S.S.	PC	Yellow		12	0.1/0.75	No
44871Y	Fit 'N Forget S.S.	AC	Yellow		12	0.1/0.75	Yes

## SUPER 44® , LED, 60 DIODES, 4" ROUND, GROMMET MOUNT, KIT

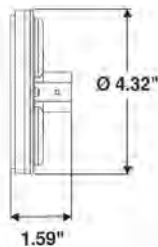

- LEDs do not have a filament, therefore are not susceptible to damage from shock and vibration
- Less current draw, resulting in increased battery and alternator life while allowing more power for other vehicle requirements
- Front, Park and Turn lamps meet stringent SAE and NHTSA requirements



Part Number	Lamp Connection	Plug Side 1	Plug Side 2	Lens Material	Lens Color	Mount/Trim Color	Volts	Amps Major/Minor	Diamond Shell	Kit Includes/Replacement Parts
44003Y	Fit 'N Forget S.S.	Fit 'N Forget S.S.	Straight Female PL-3	PC	Yellow	Black	12	0.1/0.75	No	44203Y light, 94706 plug, 40700 grommet
44071Y	Fit 'N Forget S.S.	Fit 'N Forget S.S.	Straight Female PL-3	AC	Yellow	Black	12	0.1/0.75	Yes	44871Y light, 94706 plug, 40700 grommet

## Keep Your Connections Safe. Don't Forget Your Dielectric Gel.

Dielectric gel protects your lights by protecting the points of contact between elements of your lighting and harness system. Our dielectric compounds prevent arcing and corrosion and keep your lights performing as they should.

You can find our dielectric products on page 498





## SUPER 44<sup>®</sup>, LED, 60 DIODES, 4" ROUND, FLANGE MOUNT



- LEDs do not have a filament, therefore are not susceptible to damage from shock and vibration
- Less current draw, resulting in increased battery and alternator life while allowing more power for other vehicle requirements
- Front, Park and Turn lamps meet stringent SAE and NHTSA requirements



Part Number	Lamp Connection	Lens Material	Lens Color	Mount/Trim Color	Volts	Amps Major/Minor	Diamond Shell
44223Y	Fit 'N Forget S.S.	PC	Yellow	Gray	12	0.1/0.75	No
44224Y	Fit 'N Forget S.S.	PC	Yellow	Black	12	0.1/0.75	No
44233Y	Fit 'N Forget S.S.	PC	Yellow	White	12	0.1/0.75	No
44877Y	Fit 'N Forget S.S.	AC	Yellow	Gray	12	0.1/0.75	Yes
44878Y	Fit 'N Forget S.S.	AC	Yellow	Black	12	0.1/0.75	Yes

## SUPER 44<sup>®</sup>, LED, 6 DIODES, 4" ROUND, FLANGE MOUNT, KIT



- LEDs do not have a filament, therefore are not susceptible to damage from shock and vibration
- Less current draw, resulting in increased battery and alternator life while allowing more power for other vehicle requirements
- Front, Park and Turn lamps meet stringent SAE and NHTSA requirements



Part Number	Lamp Connection	Plug Side 1	Plug Side 2	Lens Material	Lens Color	Mount/Trim Color	Volts	Amps Major/Minor	Diamond Shell	Kit Includes/Replacement Parts
44023Y	Fit 'N Forget S.S.	Fit 'N Forget S.S.	Straight Female PL-3	PC	Yellow	Gray	12	0.1/0.75	No	44223Y light, 94706 plug
44024Y	Fit 'N Forget S.S.	Fit 'N Forget S.S.	Straight Female PL-3	PC	Yellow	Black	12	0.1/0.75	No	44224Y light, 94706 plug

## 60<sup>®</sup> SERIES, LED, 44 DIODES, 2" X 6" OVAL, GROMMET MOUNT

LED

60 SERIES

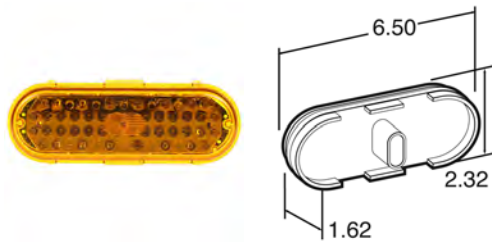

- Faster illumination offers significant safety benefit for following drivers to react quickly, resulting in an average of 3' reaction time advantage for every 10 m.p.h.
- Meets stringent Front, Park and Turn requirements
- LEDs do not have a filament, therefore are not susceptible to damage from shock and vibration
- Less current draw, resulting in increased battery and alternator life while allowing more power for other vehicle requirements



Part Number	Lamp Connection	Lens Material	Lens Color	Volts	Amps Major/Minor	Diamond Shell
60290Y	Fit 'N Forget S.S.	PC	Yellow	12	0.55 / 0.08	No
60892Y	Fit 'N Forget S.S.	AC	Yellow	12	0.55 / 0.08	Yes

## 60<sup>®</sup> SERIES, LED, 44 DIODES, 2" X 6" OVAL, GROMMET MOUNT, KIT

LED

60 SERIES



- Faster illumination offers significant safety benefit for following drivers to react more quickly, resulting in an average of 3' reaction time advantage for every 10 m.p.h.
- Meets stringent Front, Park and Turn requirements
- LEDs do not have a filament, therefore are not susceptible to damage from shock and vibration
- Less current draw, resulting in increased battery and alternator life while allowing more power for other vehicle requirements



Part Number	Lamp Connection	Plug Side 1	Plug Side 2	Lens Material	Lens Color	Mount/Trim Color	Volts	Amps Major/Minor	Diamond Shell	Kit Includes/Replacement Parts
60094Y	Fit 'N Forget S.S.	Fit 'N Forget S.S.	Straight Female PL-3	PC	Yellow	Black	12	0.55 / 0.08	No	60290Y light, 94706 plug, 60700 grommet
60074Y	Fit 'N Forget S.S.	Fit 'N Forget S.S.	Packard Connector 12015793	PC	Yellow	Black	12	0.55 / 0.08	No	60701 grommet

## 60<sup>®</sup> SERIES, LED, 44 DIODES, 2" X 6" OVAL, FLANGE MOUNT



- Faster illumination offers significant safety benefit for following drivers to react more quickly, resulting in an average of 3' reaction time advantage for every 10 m.p.h.
- Meets stringent Front, Park and Turn requirements
- LEDs do not have a filament, therefore are not susceptible to damage from shock and vibration
- Less current draw, resulting in increased battery and alternator life while allowing more power for other vehicle requirements

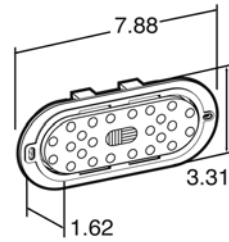

Part Number	Lamp Connection	Lens Material	Lens Color	Mount/Trim Color	Volts	Amps Major/Minor	Diamond Shell
60291Y	Fit 'N Forget S.S.	PC	Yellow	Gray	12	0.55 / 0.09	No
60292Y	Fit 'N Forget S.S.	PC	Yellow	Black	12	0.55 / 0.09	No

## 60<sup>®</sup> SERIES, LED, 44 DIODES, 2" X 6" OVAL, FLANGE MOUNT, KIT



- Faster illumination offers significant safety benefit for following drivers to react more quickly, resulting in an average of 3' reaction time advantage for every 10 m.p.h.
- Meets stringent Front, Park and Turn requirements
- LEDs do not have a filament, therefore are not susceptible to damage from shock and vibration
- Less current draw, resulting in increased battery and alternator life while allowing more power for other vehicle requirements

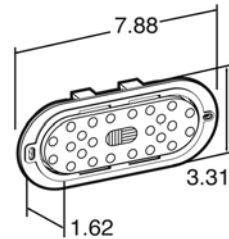

Part Number	Lamp Connection	Plug Side 1	Plug Side 2	Lens Material	Lens Color	Mount/Trim Color	Volts	Amps Major/Minor	Diamond Shell	Kit Includes/Replacement Parts
60096Y	Fit 'N Forget S.S.	Fit 'N Forget S.S.	Straight Female PL-3	PC	Yellow	Gray	12	0.55 / 0.09	No	60291Y light, 94706 plug
60097Y	Fit 'N Forget S.S.	Fit 'N Forget S.S.	Straight Female PL-3	PC	Yellow	Black	12	0.55 / 0.09	No	60292Y light, 94706 plug

91<sup>®</sup> SERIES, LED, 47 DIODES, 7" ROUND, 4 SCREW MOUNT

LED

SUPER 44

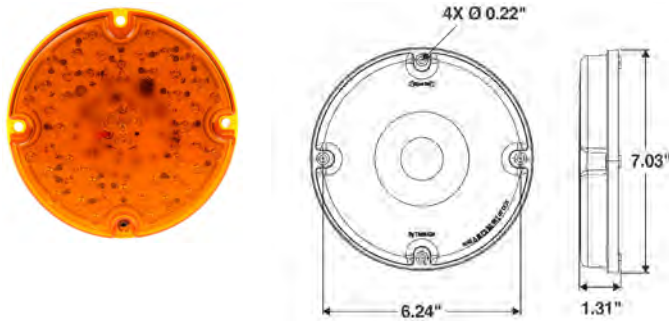

Part Number	Lamp Connection	Plug Side 1	Plug Side 2	Lens Material	Lens Color	Volts	Amps Major/Minor	Diamond Shell
91370Y	Hardwired	Hardwired	Packard Connector 12015792	AC	Yellow	12	0.65 / 0.04	No

# Looking for even more product information?

Visit [truck-lite.com](http://truck-lite.com)



Powerful Search Function



360° Product Images



Easy-To-Find Replacement Parts

## SIGNAL-STAT, LED, 10 DIODES, 4" ROUND, GROMMET MOUNT



- Uses standard PL-3 connector
- When properly mounted, exceeds FMVSS-P2 DOT requirements for marker/clearance performance
- Designed with impact-resistant acrylic material
- Sealed lens and housing locks moisture out
- Snap fit grommet requires no screws for installation
- LEDs do not have a filament, therefore are not susceptible to damage from shock and vibration
- Epoxy-encapsulated electronics prevents damage from moisture and corrosion
- Popular on owner/operator and show trucks

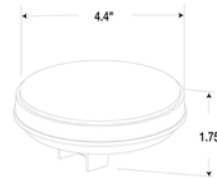

Part Number	Lamp Connection	Lens Material	Lens Color	Mount/Trim Color	Volts	Amps Major/Minor	Diamond Shell
4058A	PL-3	AC	Yellow		12	0.02/0.12	No

## SIGNAL-STAT, LED, 24 DIODES, 4" ROUND, GROMMET MOUNT



- Popular on owner/operator show trucks
- Uses standard right angle connection
- Unique LED array displays a full pattern light output design
- Epoxy-encapsulated electronics prevents damage from moisture and corrosion
- Less current draw, resulting in increased battery and alternator life while allowing more power for other vehicle requirements
- LEDs do not have a filament, therefore are not susceptible to damage from shock and vibration

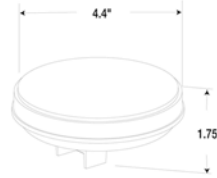

Part Number	Lamp Connection	Lens Material	Lens Color	Mount/Trim Color	Volts	Amps Major/Minor	Diamond Shell
4050A	PL-3	PC	Yellow		12	0.03/0.38	No
4051A	PL-3	PC	Clear Yellow		12	0.03/0.38	No

## SIGNAL-STAT, LED, 24 DIODES, 4" ROUND, FLANGE MOUNT



- Housing and flange are molded together to form one piece
- Uses standard right angle PL-3 connection
- Designed with impact-resistant polycarbonate material
- LEDs do not have a filament, therefore are not susceptible to damage from shock and vibration
- Epoxy-encapsulated electronics prevents damage from moisture and corrosion
- When properly mounted, exceeds FMVSS DOT requirements for S/T/T and F/P/T

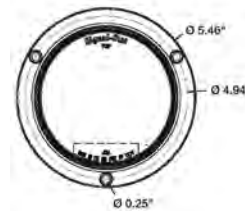

Part Number	Lamp Connection	Lens Material	Lens Color	Mount/Trim Color	Volts	Amps Major/Minor	Diamond Shell
4053A	PL-3	PC	Yellow	Gray	12	0.01/0.14	No

## SIGNAL-STAT, LED, 10 DIODES, 2" X 6" OVAL, GROMMET MOUNT

LED

SIGNAL-STAT

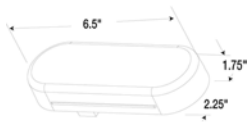

- When properly mounted, exceeds FMVSS-P2 DOT requirements for marker/clearance performance
- Designed with impact-resistant acrylic material
- Sealed lens and housing locks moisture out
- Snap fit grommet requires no screws for installation
- LEDs do not have a filament, therefore are not susceptible to shock and vibration damage major cause of failure for lamps with an incandescent bulb
- Epoxy-encapsulated electronics prevents damage from moisture and corrosion
- Popular on owner/operator and show trucks



Part Number	Lamp Connection	Lens Material	Lens Color	Volts	Amps Major/Minor	Diamond Shell
6058A	PL-3	AC	Yellow	12	0.17 / 0.02	No

## SIGNAL-STAT, LED, 24 DIODES, 2" X 6" OVAL, GROMMET MOUNT

LED

SIGNAL-STAT



- Popular for owner/operator show trucks
- Uses standard right angle plug
- Unique LED array displays full pattern light output design
- Epoxy-encapsulated electronics prevents damage from moisture and corrosion



Part Number	Lamp Connection	Lens Material	Lens Color	Volts	Amps Major/Minor	Diamond Shell
6050A	PL-3	PC	Yellow	12	0.38 / 0.03	No
6051A	PL-3	PC	Clear Yellow	12	0.38 / 0.03	No

## SIGNAL-STAT, LED, 24 DIODES, 2" X 6" OVAL, FLANGE MOUNT

LED

SIGNAL-STAT

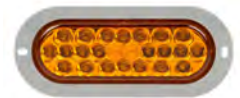

- Housing and flange are molded together to form one piece
- Uses standard right angle PL-3 connection
- Designed with impact-resistant polycarbonate material
- LEDs do not have a filament, therefore are not susceptible to shock and vibration damage major cause of failure for lamps with an incandescent bulb
- Epoxy-encapsulated electronics prevents damage from moisture and corrosion
- When properly mounted, exceeds FMVSS DOT requirements for S/T/T and F/P/T



Part Number	Lamp Connection	Lens Material	Lens Color	Mount/Trim Color	Volts	Amps Major/Minor	Diamond Shell
6053A	PL-3	PC	Yellow	Gray	12	0.26 / 0.02	No

# Looking for even more product information?

Visit [truck-lite.com](http://truck-lite.com)



**Powerful Search  
Function**



**360° Product  
Images**



**Easy-To-Find  
Replacement  
Parts**

## 40® SERIES, INCANDESCENT, 1 BULB, 4" ROUND, GROMMET MOUNT



- Heavy-duty bulb for long-lasting life
- Uniquely designed shock mount extends lamp life
- Available with or without reflectorized lens
- Flush-mount grommets are designed for mounting in a 4 1/2" hole
- 8 square inch (illuminating) stop/turn lens area for vehicles under 80 inches wide
- Meets reflex, tail or clearance function for vehicles over 80 inches wide
- Upgrade to LED lighting systems using Truck-Lite's Super 44 series of products

Part Number	Lamp Connection	Lens Material	Lens Color	Volts	Amps Major/Minor	Housing Color
40202Y	PL-3	PC	Yellow	12	2.1 / 0.48	White
40206Y	PL-3	PC	Yellow	12	2.1 / 0.48	Clear
40209Y	PL-3	PC	Yellow	24	0.93 / 0.34	White

## 40® SERIES, INCANDESCENT, 1 BULB, 4" ROUND, GROMMET MOUNT, KIT



- Heavy-duty bulb for long-lasting life
- Unique-designed shock mount extends lamp life
- Available with or without reflectorized lens
- Flush-mount grommets are designed for mounting in a 4 1/2" hole
- 8 square inch (illuminating) stop/turn lens area for vehicles under 80 inches wide.
- Meets reflex, tail or clearance function for vehicles over 80 inches wide
- Upgrade to LED lighting systems using Truck-Lite's Super 44 series of products

Part Number	Lamp Connection	Plug Side 1	Plug Side 2	Lens Material	Lens Color	Mount/Trim Color	Volts	Amps Major/Minor	Kit Includes/Replacement Parts
40002Y	PL-3	Right Angle PL-3	Stripped End/Ring Terminal	PC	Yellow	Black	12	2.1 / 0.48	40202Y light, 94993 plug, 40700 grommet
40009Y	PL-3	Right Angle PL-3	Stripped End/Ring Terminal	PC	Yellow	Black	24	0.93 / 0.34	40209Y light, 94993 plug, 40700 grommet
40302Y	Socket Assembly	Socket Assembly	Stripped End/Ring Terminal	PC	Yellow	Black	12	2.1 / 0.48	99010Y light

## 40® SERIES, INCANDESCENT, 1 BULB, 4" ROUND, FLANGE MOUNT

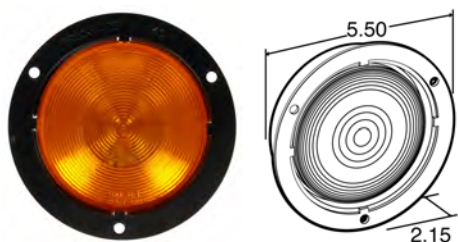

- Heavy-duty bulb for long-lasting life
- Uniquely designed shock mount extends lamp life
- Available with or without reflectorized lens
- Flush-mount grommets are designed for mounting in a 4 1/2" hole
- 8 square inch (illuminating) stop/turn lens area for vehicles under 80 inches wide
- Meets reflex, tail or clearance function for vehicles over 80 inches wide
- Upgrade to LED lighting systems using Truck-Lite's Super 44 series of products

Part Number	Lamp Connection	Lens Material	Lens Color	Mount/Trim Color	Volts	Amps Major/Minor
40233Y	PL-3	PC	Yellow	Black	12	2.1 / 0.48

INCANDESCENT

40 SERIES

INCANDESCENT

40 SERIES

INCANDESCENT

40 SERIES



## 40<sup>®</sup> ECONOMY, INCANDESCENT, 1 BULB, 4" ROUND, GROMMET MOUNT



- Grommet kit features flush mounting in a 4 1/2" hole
- Flange kits feature a high-impact plastic affixed to lamp
- 8 square inch (illuminating) stop/turn lens area for vehicles under 80 inches wide
- Meets reflex, tail or clearance function for vehicles over 80 inches wide
- Upgrade to LED lighting systems using Truck-Lite's LED 44 Series lighting products

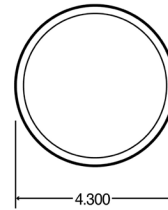

Part Number	Lamp Connection	Lens Material	Lens Color	Mount/Trim Color	Volts	Amps Major/Minor
40282Y	PL-3	PC	Yellow		12	2.1 / 0.48

INCANDESCENT

40 ECONOMY

## 40<sup>®</sup> ECONOMY, INCANDESCENT, 1 BULB, 4" ROUND, GROMMET MOUNT, KIT



- Grommet kit features flush mounting in a 4 1/2" hole
- Flange kits feature a high-impact plastic affixed to lamp
- 8 square inch (illuminating) stop/turn lens area for vehicles under 80 inches wide
- Meets reflex, tail or clearance function for vehicles over 80 inches wide
- Upgrade to LED lighting systems using Truck-Lite's LED 44 Series lighting products

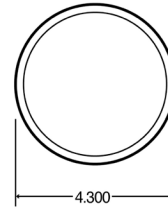

Part Number	Lamp Connection	Plug Side 1	Plug Side 2	Lens Material	Lens Color	Mount/Trim Color	Volts	Amps Major/Minor	Kit Includes/Replacement Parts
40028Y	PL-3	Right Angle PL-3	Stripped End/Ring Terminal	PC	Yellow	Black	12	2.1 / 0.48	40282Y light, 94993 plug, 40700 grommet

INCANDESCENT

40 ECONOMY

## SUPER 45<sup>®</sup>, INCANDESCENT, 1 BULB, 3"X 5" RECTANGULAR, GROMMET MOUNT

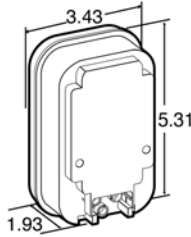

- Mount horizontally or vertically
- Heavy-duty, dual-filament cartridge bulb
- Unique shock mount absorbs shock and vibration
- Upgrade to LED lighting systems using Truck-Lite's Super 45 LED series product line



Part Number	Lamp Connection	Lens Material	Lens Color	Mount/Trim Color	Volts	Amps Major/Minor
45202Y	PL-3	PC	Yellow	Black	12	2.16 / 0.47

## SUPER 45<sup>®</sup>, INCANDESCENT, 1 BULB, 3"X 5" RECTANGULAR, GROMMET MOUNT, KIT

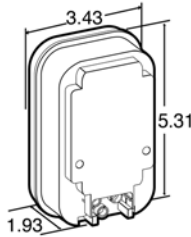

- Mount horizontally or vertically
- Heavy-duty, dual-filament cartridge bulb
- Unique shock mount absorbs shock and vibration
- Upgrade to LED lighting systems using Truck-Lite's Super 45 LED series product line



Part Number	Lamp Connection	Plug Side 1	Plug Side 2	Lens Material	Lens Color	Mount/Trim Color	Volts	Amps Major/Minor	Kit Includes/Replacement Parts
45002Y	PL-3	Right Angle PL-3	Stripped End/Ring Terminal	PC	Yellow	Black	12	2.16 / 0.47	45202Y light, 94993 plug, 45700 grommet

## 60<sup>®</sup> SERIES, INCANDESCENT, 1 BULB, 2"x 6" OVAL, GROMMET MOUNT, KIT

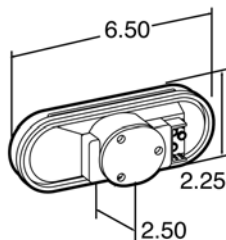

- Direct replacement for approved lamps on the United States Postal Service L.L.V (Long Life Vehicles)
- Features a heavy-duty shock-mounted bulb
- Four versions, each features center high mount stop functions, park and turn functions, rear side marker and turn functions, or front side marker and turn signal functions



Part Number	Lamp Connection	Plug Side 1	Plug Side 2	Lens Material	Lens Color	Mount/Trim Color	Volts	Amps Major/Minor	Kit Includes/Replacement Parts
60022Y	PL-3	Right Angle PL-3	Stripped End/Ring Terminal	PC	Yellow	Black	12	2.1 / 0.48	60202Y light, 60701 grommet, 94839 plug

INCANDESCENT

45 SERIES

INCANDESCENT

45 SERIES

INCANDESCENT

60 SERIES

## 60<sup>®</sup> SERIES, INCANDESCENT, 1 BULB, 2"x 6" OVAL, GROMMET MOUNT, KIT



- Lamp may be either grommet or screw mounted
- Mounts horizontally or vertically
- .250 Internal Knockout hole / 1.620 Clearance hole
- Upgrade to Truck-Lite LED Lighting Systems using 60 Series LED products

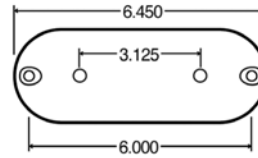

Part Number	Lamp Connection	Plug Side 1	Plug Side 2	Lens Material	Lens Color	Mount/Trim Color	Volts	Amps Major/Minor	Kit Includes/Replacement Parts
60302Y	Hardwired	Hardwired	Stripped End/Ring Terminal	PC	Yellow	Black	12	2.1 / 0.48	60781 light, 99011Y lens

INCANDESCENT

60 SERIES

## 60<sup>®</sup> SERIES, INCANDESCENT, 1 BULB, 2"x 6" OVAL, GROMMET MOUNT, KIT



- Socket assembly cams-out for ease in bulb replacement
- Mounts horizontally or vertically
- Upgrade to Truck-Lite LED Lighting Systems using Super 66 or 60 Series LED products

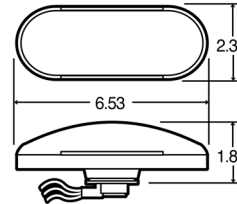

Part Number	Lamp Connection	Plug Side 1	Plug Side 2	Lens Material	Lens Color	Mount/Trim Color	Volts	Amps Major/Minor	Kit Includes/Replacement Parts
60340Y	Socket Assembly	Socket Assembly	Stripped End/Ring Terminal	PC	Yellow	Black	12	2.1 / 0.48	99184Y light, 95407 plug

INCANDESCENT

60 SERIES

## SUPER 60<sup>®</sup>, INCANDESCENT, 1 BULB, 2"x 6" OVAL, GROMMET MOUNT



- Mount horizontally or vertically
- Right angle plug assembly
- Upgrade to Truck-Lite LED lighting systems using Super 66 or 60 Series LED products

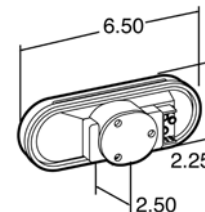

Part Number	Lamp Connection	Lens Material	Lens Color	Mount/Trim Color	Volts	Amps Major/Minor
60202Y	PL-3	PC	Yellow		12	2.1 / 0.48
60207Y	PL-3	PC	Yellow		24	0.93 / 0.34

INCANDESCENT

SUPER 60

## SUPER 60®, INCANDESCENT, 1 BULB, 2"x 6" OVAL, GROMMET MOUNT

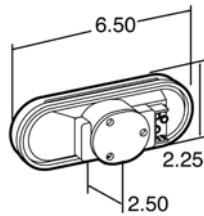

- Mount horizontally or vertically
- Right angle plug assembly
- Upgrade to Truck-Lite LED lighting systems using Super 66 or 60 Series LED products



Part Number	Lamp Connection	Plug Side 1	Plug Side 2	Lens Material	Lens Color	Mount/Trim Color	Volts	Amps Major/Minor	Kit Includes/Replacement Parts
60002Y	PL-3	Right Angle PL-3	Stripped End/Ring Terminal	PC	Yellow	Black	12	2.1 / 0.48	60202Y light, 94993 plug, 60700 grommet

## 60® ECONOMY, INCANDESCENT, 1 BULB, 2"x 6" OVAL, GROMMET MOUNT

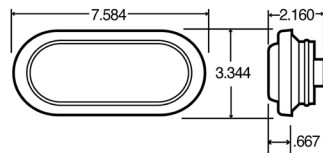

- Mount horizontally or vertically
- Contains a heavy-duty, dual filament bulb
- Upgrade to Truck-Lite LED lighting systems using Super 66 or 60 Series LED products



Part Number	Lamp Connection	Lens Material	Lens Color	Mount/Trim Color	Volts	Amps Major/Minor
60283Y	PL-3	PC	Yellow		12	2.1 / 0.48

## 60® ECONOMY, INCANDESCENT, 1 BULB, 2"x 6" OVAL, GROMMET MOUNT, KIT

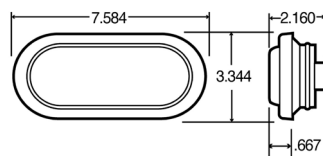

- Mount horizontally or vertically
- Contains a heavy-duty, dual-filament bulb
- Upgrade to Truck-Lite LED lighting systems using Super 66 or 60 Series LED products



Part Number	Lamp Connection	Plug Side 1	Plug Side 2	Lens Material	Lens Color	Mount/Trim Color	Volts	Amps Major/Minor	Kit Includes/Replacement Parts
60083Y	PL-3	Right Angle PL-3	Stripped End/Ring Terminal	PC	Yellow	Black	12	2.1 / 0.48	60283Y light, 94993 plug, 60700 grommet

INCANDESCENT

60 ECONOMY

INCANDESCENT

SUPER 60

## 91<sup>®</sup> SERIES, INCANDESCENT, 1 BULB, 7" ROUND, 4 SCREW MOUNT



- Contains a heavy-duty, shock-mount, 12 volt bulb
- Mounting gasket provides additional protection between lamp and body
- Mounts in a 5.375" hole

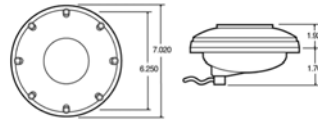

Part Number	Lamp Connection	Lens Material	Lens Color	Mount/Trim Color	Volts	Amps Major/Minor
91202Y	PL-3	PC	Yellow	Yellow	12	2.1 / 0.48
91205Y	PL-3	PC	Yellow	Yellow	24	0.93 / 0.34

INCANDESCENT

91 SERIES

## 91<sup>®</sup> SERIES, INCANDESCENT, 1 BULB, 7" ROUND, 4 SCREW MOUNT, KIT



- Contains a heavy-duty shock-mount 12 volt bulb
- Mounting gasket provides additional protection between lamp and body
- Mounts in a 5.375" hole

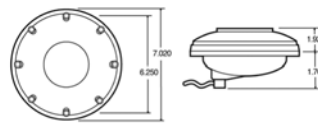

Part Number	Lamp Connection	Plug Side 1	Plug Side 2	Lens Material	Lens Color	Mount/Trim Color	Volts	Amps Major/Minor	Kit Includes/Replacement Parts
91002Y	PL-3	Right Angle PL-3	Stripped End/Ring Terminal	PC	Yellow	Yellow	12	2.1 / 0.48	91202Y light, 94993 plug
91315Y	Socket Assembly	Socket Assembly	Stripped End/Ring Terminal	PC	Yellow	Yellow	12	2.1 / 0.59	99021Y light, 95407 socket

INCANDESCENT

91 SERIES

## 1 BULB, 7" ROUND, 4 SCREW MOUNT

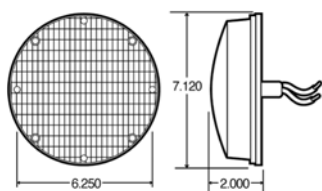

- Surface mounts with four bolts on a 6.25" bolt circle
- Requires a 1" diameter hole, 1" deep
- Popular lamp on buses and emergency vehicles
- Replaces Signal-Stat 6504



Part Number	Lamp Connection	Plug Side 1	Plug Side 2	Lens Material	Lens Color	Mount/Trim Color	Volts	Amps Major/Minor
90327Y	Hardwired	Hardwired	Blunt Cut	AC	Yellow	Yellow	12	2.1 / 0.59

## 1 BULB, 4"x 6" RECTANGULAR, 4 SCREW MOUNT

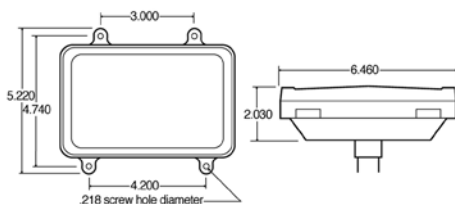

Part Number	Lamp Connection	Lens Material	Lens Color	Mount/Trim Color	Volts	Amps Major/Minor
7080	Packard Connector 6288471	PC	Yellow	Yellow	12	2.1 / 0.48

## 1 BULB, 6"x 10" RECTANGULAR, 4 SCREW MOUNT

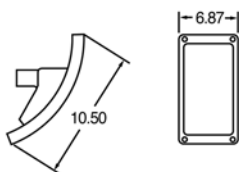

- Navistar #1677715C91
- Can be used as right or left hand housing
- Accepts rear entry bulb socket and harness assembly, not included

Part Number	Lamp Connection	Lens Material	Lens Color	Mount/Trim Color	Volts	Amps Major/Minor
4097A	Socket Assembly	PC	Yellow	Yellow	12	2.1 / 0.48

## TRUCK-LITE, INCANDESCENT, 1 BULB, 4" ROUND, FLANGE MOUNT

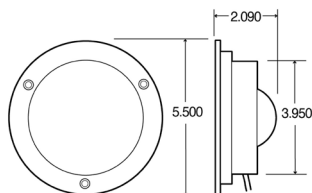

- Mounts flush to vehicle
- Retaining ring allows for easy bulb replacement
- Not intended for use as (P2) clearance
- Upgrade to Truck-Lite LED lighting systems using Super 44 products



Part Number	Lamp Connection	Plug Side 1	Plug Side 2	Lens Material	Lens Color	Mount/Trim Color	Volts	Amps Major/Minor
80302Y	Hardwired	Hardwired	Blunt Cut	AC	Yellow	Black	12	2.47 / 0.48

INCANDESCENT

7 IN ROUND

INCANDESCENT

4 IN X 6 IN

INCANDESCENT

6 IN X 10 IN

INCANDESCENT

4 IN ROUND

## 45<sup>®</sup> SERIES, LED, 15 DIODES, 3"X5", GROMMET MOUNT, KIT



- Direct replacement for approved lamps on the United States Postal Service L.L.V.
- Designed for mounting on a 7 - 11 degree rollback from the vertical plane
- Vertical-mount only



Part Number	Lamp Connector	Plug Side 1	Plug Side 2	Lens Color	Lens Material	Mount Color	Volts	Amps Major/Minor	Kit Includes
45032R	Hardwired	Hardwired	Packard Connector 12015793	Red	PC	Black	12	0.5/0.04	45701 grommet, 60701 grommet

LED  
45 SERIES

## 60<sup>®</sup> SERIES, INCANDESCENT, 1 BULB, 2"X6", GROMMET MOUNT, KIT



- Direct replacement for approved lamps on the United States Postal Service L.L.V (Long Life Vehicles)
- Features a heavy-duty shock-mounted bulb
- Four versions, each features center high mount stop functions, park and turn functions, rear side marker and turn functions, or front side marker and turn signal functions

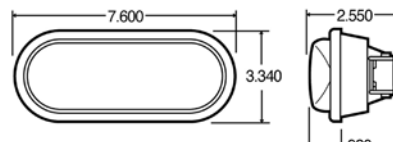

Part Number	Lamp Connector	Plug Side 1	Plug Side 2	Lens Color	Lens Material	Mount Color	Volts	Amps Major/Minor	Kit Includes/ Replacement Parts
60021R	PL-2	Right Angle PL-2	Packard Connector 12020398	Red	PC	Black	12	1.66/1.22	45701 grommet, 60701 grommet

INCANDESCENT  
60 SERIES

## 60<sup>®</sup> SERIES, INCANDESCENT, 1 BULB, 2"X6", GROMMET MOUNT, KIT, REFLECTORIZED



- Direct replacement for approved lamps on the United States Postal Service L.L.V (Long Life Vehicles)
- Features a heavy-duty shock-mounted bulb
- Four versions, each features center high mount stop functions, park and turn functions, rear side marker and turn functions, or front side marker and turn signal functions

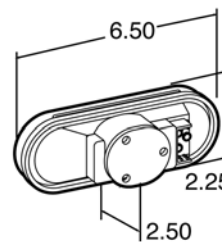

Part Number	Lamp Connector	Plug Side 1	Plug Side 2	Lens Color	Lens Material	Mount Color	Volts	Amps Major/Minor	Kit Includes/ Replacement Parts
60023R	PL-2	Right Angle PL-2	Packard Connector 12015793	Red	PC	Black	12	2.1/0.48	45701 grommet, 60701 grommet
60024Y	PL-3	Right Angle PL-3	Weather Connector 12015793	Yellow	PC	Black	12	2.1/0.48	60215Y signal, 60701 grommet, 94840 plug

INCANDESCENT  
60 SERIES

LED

SINGLE FACE

## SINGLE FACE, LED, 24 DIODE , 3 WIRES, ROUND, 1 STUD MOUNT

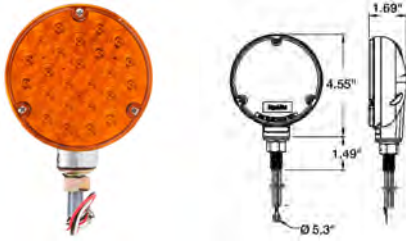

- Chrome plated housing
- Ideal for show trucks, highway, mowing, municipal and farm equipment



Part Number	Lamp Connector	Plug Side 1	Plug Side 2	Lens Color	Housing Material	Housing Color	Volts	Amps Major/Minor
2751	Hardwired	Hardwired	Stripped End Ring Terminal	Red	Zinc	Chrome	12	0.24/0.01
2751A	Hardwired	Hardwired	Stripped End Ring Terminal	Yellow	Zinc	Chrome	12	0.36/0.03
80867	Hardwired	Hardwired	Packard Connector	Yellow	Zinc	Black	12	0.36/0.03

LED

DUAL FACE

## DUAL FACE, LED, 24 DIODE, 3 WIRES, ROUND, 1 STUD MOUNT



- Ideal for show trucks, highway, mowing, municipal and farm equipment
- Chrome-plated housing



Part Number	Lamp Connector	Plug Side 1	Plug Side 2	Lens Color	Housing Material	Housing Color	Volts	Amps Major/Minor
2750	Hardwired	Hardwired	Stripped End/Ring Terminal	Red   Yellow	Zinc	Chrome	12	0.73/0.05

LED

DUAL FACE

## DUAL FACE, LED, 24 DIODE, 2 WIRES, SQUARE, 1 STUD MOUNT



- Ideal for show trucks, highway, mowing, municipal and farm equipment
- Unique LED array displays full pattern output
- Side marker reflex reflector
- LEDs do not have a filament, therefore are not susceptible to damage from shock and vibration
- LEDs have less current draw, resulting in increased battery and alternator life while allowing more power for other vehicle requirements
- Chrome-plated housing
- Meets SAE J974 for agricultural warning devices
- Epoxy encapsulated electronics protect the lamp from damage caused by chemicals and moisture



Part Number	Lamp Connector	Plug Side 1	Plug Side 2	Lens Color	Housing Material	Housing Color	Volts	Amps Major/Minor
2752	Hardwired	Hardwired	Stripped End/Ring Terminal	Yellow	ABS	Chrome	12	0.45



## DUAL FACE, LED, 24 DIODE, 3 WIRES, SQUARE, 1 STUD MOUNT



- Ideal for show trucks, highway, mowing, municipal and farm equipment
- Unique LED array displays full pattern output
- Side marker reflex reflector
- LEDs do not have a filament, therefore are not susceptible to damage from shock and vibration
- LEDs have less current draw, resulting in increased battery and alternator life while allowing more power for other vehicle requirements
- Chrome plated housing
- Meets SAE J974 for agricultural warning devices
- Epoxy-encapsulated electronics protect the lamp from damage caused by chemicals and moisture

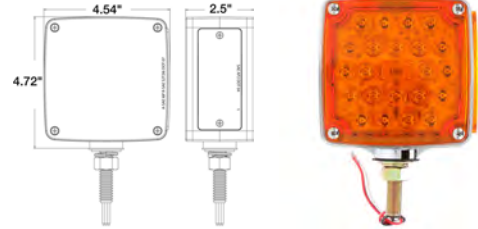

Part Number	Position	Lamp Connector	Plug Side 1	Plug Side 2	Lens Color	Housing Material	Housing Color	Volts	Amps Major/Minor
2753	LH	Hardwired	Hardwired	Stripped End/Ring Terminal	Red   Yellow	Zinc	Chrome	12	0.38/0.04
2756	RH	Hardwired	Hardwired	Stripped End/Ring Terminal	Red   Yellow	Zinc	Chrome	12	0.38/0.04

## DUAL FACE, LED, 24 DIODE, 3 WIRES, SQUARE, 2 STUD MOUNT



- Ideal for show trucks, highway, mowing, municipal and farm equipment
- Unique LED array displays full pattern output
- Side marker reflex reflector
- LEDs do not have a filament, therefore are not susceptible to damage from shock and vibration
- LEDs have less current draw, resulting in increased battery and alternator life while allowing more power for other vehicle requirements
- Epoxy-encapsulated electronics protect the lamp from damage caused by chemicals and moisture
- Double-stud mount

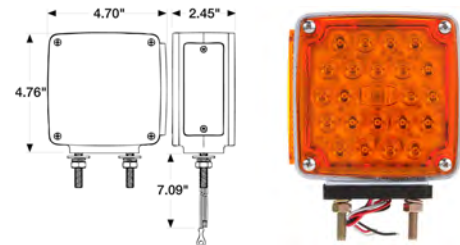

Part Number	Position	Lamp Connector	Plug Side 1	Plug Side 2	Lens Color	Housing Material	Housing Color	Volts	Amps Major/Minor
2758	RH	Hardwired	Hardwired	Stripped End/Ring Terminal	Red Yellow	Zinc	Chrome	12	0.38/0.04
2759	LH	Hardwired	Hardwired	Stripped End/Ring Terminal	Red Yellow	Zinc	Chrome	12	0.38/0.04

# SINGLE FACE, INCANDESCENT, 1 WIRE, ROUND, 1 STUD MOUNT

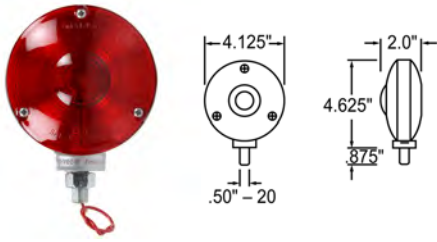

- For applications with vehicle width under 80" wide
- One-wire, signal lamp
- LED upgrade options available #2751, 2751A and 2750



Part Number	Lamp Connector	Plug Side 1	Plug Side 2	Lens Color	Housing Material	Housing Color	Volts	Amps Major/Minor
2701	Hardwired	Hardwired	Stripped End	Red	Zinc	Black	12	2.1
2701A	Hardwired	Hardwired	Stripped End	Yellow	Zinc	Black	12	2.1
3701	Hardwired	Hardwired	Stripped End	Red	Zinc	Gray	12	2.1
3711	Hardwired	Hardwired	Stripped End	Red	Zinc	Chrome	12	2.1
3711B	Hardwired	Hardwired	Stripped End	Blue	Zinc	Chrome	12	2.1

# SINGLE FACE, INCANDESCENT, 2 WIRE, ROUND, 1 STUD MOUNT, SHOCK MOUNT

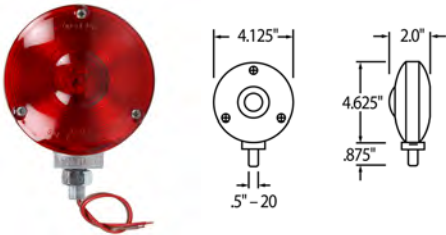

- For vehicle application with vehicle width under 80" wide
- Two-wire, stop, tail, turn lamp
- Zinc die-cast housing



Part Number	Lamp Connector	Plug Side 1	Plug Side 2	Lens Color	Housing Material	Housing Color	Volts	Amps Major/Minor
3710	Hardwired	Hardwired	Stripped End	Red	Zinc	Gray	12	2.1/0.59

## Keep Your Connections Safe. Don't Forget Your Dielectric Gel.

Dielectric gel protects your lights by protecting the points of contact between elements of your lighting and harness system. Our dielectric compounds prevent arcing and corrosion and keep your lights performing as they should.

You can find our dielectric products on page 498



# SINGLE FACE, INCANDESCENT, 2 WIRE, ROUND, 1 STUD MOUNT



- Two-wire, stop, tail, turn lamp
- Rubber O-ring seals out dirt and moisture
- Snap-on lens for easy bulb replacement
- LED upgrade options available #2751/2751A

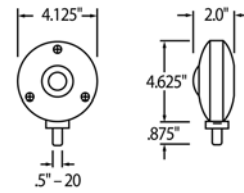

Part Number	Lamp Connector	Plug Side 1	Plug Side 2	Lens Color	Housing Material	Housing Color	Volts	Amps Major/Minor
2702	Hardwired	Hardwired	Stripped End	Red	Zinc	Black	12	2.1/0.59
2702A	Hardwired	Hardwired	Stripped End	Yellow	Zinc	Black	12	2.1/0.59
3702	Hardwired	Hardwired	Stripped End	Red	Zinc	Gray	12	2.1/0.59
3712	Hardwired	Hardwired	Stripped End	Red	Zinc	Chrome	12	2.1/0.59
3762	Hardwired	Hardwired	Stripped End	Red	Zinc	Silver	12	2.1/0.59

INCANDESCENT

SINGLE FACE

# SINGLE FACE, INCANDESCENT, 1 WIRE, ROUND, 1 STUD MOUNT



- Available as single or dual-face lamps
- Dual-face lamp mounts on a 3/8"-24 stud
- Single-face lamp mounts on a 7/16" -14 stud
- Features snap-in lens
- LED upgrade options available #2751, 2751A and 2750

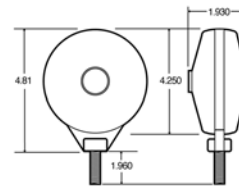

Part Number	Lamp Connector	Plug Side 1	Plug Side 2	Lens Color	Housing Material	Housing Color	Volts	Amps Major/Minor
3755A	Hardwired	Hardwired	Stripped End	Yellow	PC	Black	12	2.1
70330R	Hardwired	Hardwired	Blunt Cut	Red	PC	Gray	12	2.1
70330Y	Hardwired	Hardwired	Blunt Cut	Yellow	PC	Gray	12	2.1
3755	Hardwired	Hardwired	Stripped End	Red	PC	Black	12	2.1

INCANDESCENT

SINGLE FACE

# SINGLE FACE, INCANDESCENT, 1 WIRE, ROUND, 1 STUD MOUNT, SNAP ON LENS



- Available as single or dual-face lamps
- Dual-face lamp mounts on a 3/8"-24 stud
- Single-face lamp mounts on a 7/16" -14 stud
- Features snap-in lens
- LED upgrade options available #2751, 2751A and 2750

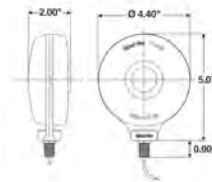

Part Number	Lamp Connector	Plug Side 1	Plug Side 2	Lens Color	Housing Material	Housing Color	Volts	Amps Major/Minor
3753	Hardwired	Hardwired	Stripped End	Red	PC	White	12	2.1
3753A	Hardwired	Hardwired	Stripped End	Yellow	PC	White	12	2.1

INCANDESCENT

SINGLE FACE

# SINGLE FACE, INCANDESCENT, 2 WIRE, ROUND, 1 STUD MOUNT



- Snap-on lens simplifies bulb and lens replacement
- Tough polycarbonate housing prevents rust and corrosion
- LED upgrade Options Available: 2751, 2751A and 2750



Part Number	Lamp Connector	Plug Side 1	Plug Side 2	Lens Color	Housing Material	Housing Color	Volts	Amps Major/Minor
70310R	Hardwired	Hardwired	Blunt Cut	Red	PC	Gray	12	2.1/0.59
3756	Hardwired	Hardwired	Stripped End	Red	PC	Black	12	2.1/0.59
3754	Hardwired	Hardwired	Stripped End Ring Terminal	Red	PC	White	12	2.1/0.59

# DUAL FACE, INCANDESCENT, 1 WIRE, ROUND, 1 STUD MOUNT

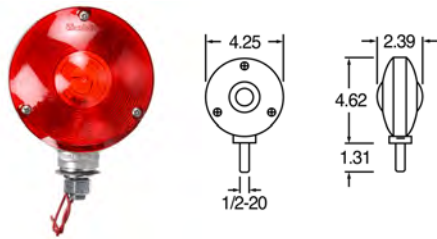

- 3805Y115 requires Phillips #28S 11/4SC or GE #13655 bulb
- For vehicle application with vehicle width under 80" wide
- Pigtail with spring and thermoplastic wire exits via hollow stud
- LED upgrade options available: 2751, 2751A and 2750



Part Number	Lamp Connector	Plug Side 1	Plug Side 2	Lens Color	Housing Material	Housing Color	Volts	Amps Major/Minor	Lens Type
2801	Hardwired	Hardwired	Stripped End	Red Yellow	Zinc	Black	12	2.1	
3801	Hardwired	Hardwired	Stripped End	Red Yellow	Zinc	Gray	12	2.1	3-Screw
3802	Hardwired	Hardwired	Stripped End	Red Yellow	Zinc	Chrome	12	2.1	
3860	Hardwired	Hardwired	Stripped End	Red Yellow	Zinc	Gray	12	2.1	0-Ring

# DUAL FACE, INCANDESCENT, 1 WIRE, ROUND, 1 STUD MOUNT, SHOCK MOUNT

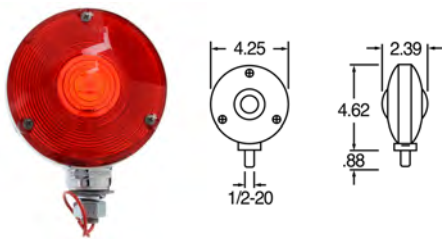

- 3805Y115 requires Phillips #28S 11/4SC or GE #13655 bulb
- For vehicle application with vehicle width under 80" wide
- Pigtail with spring and thermoplastic wire exits via hollow stud
- LED upgrade options available: 2751, 2751A and 2750



Part Number	Lamp Connector	Plug Side 1	Plug Side 2	Lens Color	Housing Material	Housing Color	Volts	Amps Major/Minor
3806	Hardwired	Hardwired	Stripped End	Red Yellow	Zinc	Chrome	12	2.1

INCANDESCENT

SINGLE FACE

INCANDESCENT

DUAL FACE

INCANDESCENT

DUAL FACE

## DUAL FACE, INCANDESCENT, 1 WIRE, ROUND, 1 STUD MOUNT, 0-RING LENS GASKET



- Snap-Grip lens allows quick bulb and lens replacement
- O-ring lens gasket seals out dirt and moisture
- Mounting: Hollow stud, 1/2" diameter
- Can use 9199 or 9296 mounting brackets

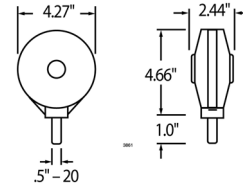

Part Number	Lamp Connector	Plug Side 1	Plug Side 2	Lens Color	Housing Material	Housing Color	Volts	Amps Major/Minor
3861	Hardwired	Hardwired	Stripped End	Red Yellow	Zinc	Chrome	12	2.1

INCANDESCENT

DUAL FACE

## DUAL FACE, INCANDESCENT, 2 WIRE, ROUND, 1 STUD MOUNT



- Snap-Grip lens allows quick bulb and lens replacement
- O-ring lens gasket seals out dirt and moisture
- Mounting: Hollow stud, 1/2" diameter
- Can use 9199 or 9296 mounting brackets

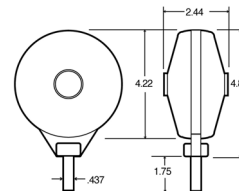

Part Number	Lamp Connector	Plug Side 1	Plug Side 2	Lens Color	Housing Material	Housing Color	Volts	Amps Major/Minor
70311	Hardwired	Hardwired	Blunt Cut	Red Yellow	PC	Yellow	12	2.1/0.59

INCANDESCENT

DUAL FACE

## DUAL FACE, INCANDESCENT, 2 WIRE, ROUND, 1 STUD MOUNT, KNOCK DOWN



- Ideal for highway mowing, municipal lawn, and farm equipment
- Spring-loaded "Knock-Down" feature allows lamp to flex under impact and return to original position
- Meets SAE J974 for agricultural warning devices

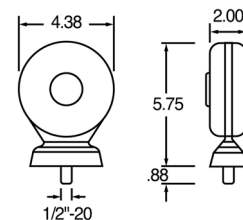

Part Number	Lamp Connector	Plug Side 1	Plug Side 2	Lens Color	Housing Material	Housing Color	Volts	Amps Major/Minor
3853AA	Hardwired	Hardwired	Stripped End	Yellow	PC	Yellow	12	2.1/0.59

INCANDESCENT

DUAL FACE

## DUAL FACE, INCANDESCENT, 2 WIRE, ROUND, 1 STUD MOUNT

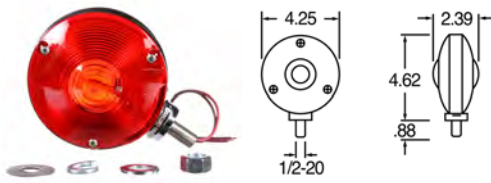

- 3805Y115 requires Phillips #28S 11/4SC or GE #13655 bulb
- For vehicle application with vehicle width under 80" wide
- Pigtail with spring and thermoplastic wire exits via hollow stud
- LED upgrade options available: 2751, 2751A and 2750



Part Number	Lamp Connector	Plug Side 1	Plug Side 2	Lens Color	Housing Material	Housing Color	Volts	Amps Major/Minor
2803	Hardwired	Hardwired	Stripped End	Red Yellow	Zinc	Black	12	2.1/0.59
3805Y115	Hardwired	Hardwired	Stripped End	Red	Zinc	Gray	12	2.1/0.59
3812	Hardwired	Hardwired	Stripped End	Red Yellow	Zinc	Chrome	12	2.1/0.59
3862	Hardwired	Hardwired	Stripped End	Red Yellow	Zinc	Gray	12	2.1/0.59
3863	Hardwired	Hardwired	Stripped End	Red Yellow	Zinc	Gray	12	2.1/0.59

## DUAL FACE, INCANDESCENT, ZINC, 3 WIRE, ROUND, 1 STUD MOUNT,

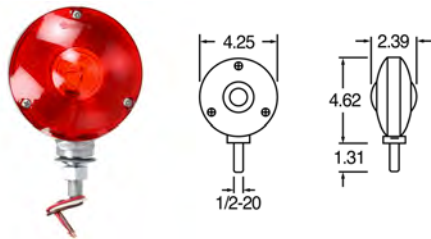

- 3805Y115 requires Phillips #28S 11/4SC or GE #13655 bulb
- For vehicle application with vehicle width under 80" wide
- Pigtail with spring and thermoplastic wire exits via hollow stud
- LED upgrade options available: 2751, 2751A and 2750



Part Number	Lamp Connector	Plug Side 1	Plug Side 2	Lens Color	Number of Bulbs	Housing Color	Volts	Amps Major/Minor
3810	Hardwired	Hardwired	Stripped End	Red Yellow	1	Chrome	12	2.1

## DUAL FACE, INCANDESCENT, POLYCARBONATE, 3 WIRE, ROUND, 1 STUD MOUNT, KNOCK DOWN

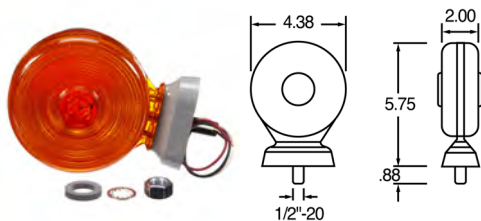

- Ideal for highway mowing, municipal lawn, and farm equipment
- Spring-loaded "Knock-Down" feature allows lamp to flex under impact and return to original position
- Meets SAE J974 for agricultural warning devices



Part Number	Lamp Connector	Plug Side 1	Plug Side 2	Lens Color	Number of Bulbs	Housing Color	Volts	Amps Major/Minor
3854	Hardwired	Hardwired	Stripped End	Red Yellow	1	Yellow	12	2.1/0.59

INCANDESCENT

DUAL FACE

INCANDESCENT

DUAL FACE

INCANDESCENT

DUAL FACE

# DUAL FACE, INCANDESCENT, POLYCARBONATE, 1 WIRE, ROUND , 1 STUD MOUNT



- High-impact black polycarbonate housing will not rust or corrode
- Lamp grounds through mounting stud
- Snap-grip lens simplifies bulb and lens replacement
- LED upgrade options available: 2751, 2751A and 2750

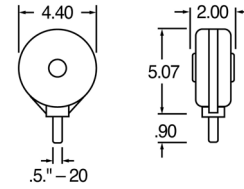

Part Number	Lamp Connector	Plug Side 1	Plug Side 2	Lens Color	Number of Bulbs	Housing Color	Volts	Amps Major/Minor
3850	Hardwired	Hardwired	Stripped End	Red Yellow	1	Black	12	2.1
3850AA	Hardwired	Hardwired	Stripped End	Yellow	1	Black	12	2.1
70300	Hardwired	Hardwired	Stripped End	Red Yellow	1	White	12	2.1

INCANDESCENT

DUAL FACE

# Looking for even more product information?

Visit [truck-lite.com](http://truck-lite.com)



Powerful Search Function



360° Product Images



Easy-To-Find Replacement Parts

INCANDESCENT

SINGLE FACE

## SINGLE FACE, INCANDESCENT, SQUARE, BRACKET MOUNT, KIT

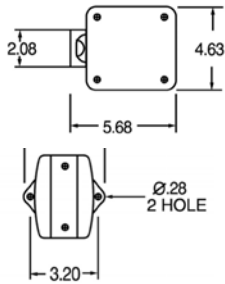

- Replaces GM #694627 (LH) and #694628 (RH)
- Combination park, turn, side marker and reflex reflector
- Mounting hardware included
- Mounts on 3.20" centers and connects with 2 spade terminals
- Unique GM harness connector (harness not available from Truck-Lite)



Part Number	Position	Lamp Connector	Lens Color	Housing Material	Housing Color	Volts	Amps Major/Minor	Kit Includes/ Replacement Parts
4854	RH	Spade Terminal	Red Yellow	ABS	Black	12	2.1/0.5	9063 lens, 9078A lens, 9080A lens
4855	LH	Spade Terminal	Red Yellow	ABS	Black	12	2.1/0.5	9063 lens, 9078A lens, 9080A lens

INCANDESCENT

DUAL FACE

## DUAL FACE, INCANDESCENT, ZINC, 1 WIRE, SQUARE, SURFACE MOUNT

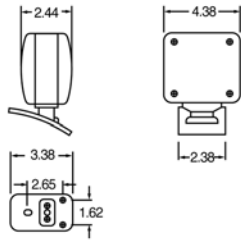

- Blade-type connector
- Die-cast base assembly
- Dual-optic lenses
- Mounting bracket included



Part Number	Lamp Connector	Plug Side 1	Plug Side 2	Lens Color	Number of Bulbs	Housing Color	Volts	Amps Major/Minor
950	Hardwired	Hardwired	Packard Connector	Red Yellow	1	Chrome	12	2.1

INCANDESCENT

DUAL FACE

## DUAL FACE, INCANDESCENT, POLYCARBONATE, SQUARE, BRACKET MOUNT, KIT

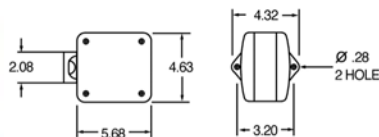

- GM #2029217
- Combination park, turn, side marker, and reflex reflector
- Mounts on 3.25" centers and connects with 3 spade terminals
- Fits left or right side
- Unique GM harness connector (harness not available from Truck-Lite)



Part Number	Lamp Connector	Lens Color	Number of Bulbs	Mount Color	Volts	Amps Major/Minor	Kit Includes
4872AA	Spade Terminal	Yellow	1	Black	12	2.1/0.5	9083A lens



## DUAL FACE, INCANDESCENT, ZINC, 2 WIRE, SQUARE, BRACKET MOUNT, KIT



- Die-cast base assembly
- Receptacle type connector
- Mounting bracket included

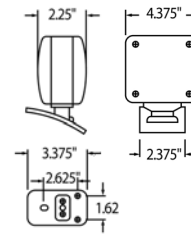

Part Number	Lamp Connector	Plug Side 1	Plug Side 2	Lens Color	Number of Bulbs	Mount Color	Volts	Amps Major/Minor	Kit Includes
956AA	Hardwired	Hardwired	Female .180 Bullet	Yellow	1	Chrome	12	2.1/0.5	8960 lens, 8960A lens
957AA	Hardwired	Hardwired	.180 Bullet/ Female .180 Bullet	Yellow	1	Chrome	12	2.1/0.5	8960 lens, 8960A lens

INCANDESCENT

DUAL FACE

## DUAL FACE, INCANDESCENT, 1 WIRE, SQUARE, 1 STUD MOUNT



- Dual-optic lenses
- Die-cast base assembly
- Mounts left or right, horizontally or vertically
- Mounting hardware for stud or pedestal installation

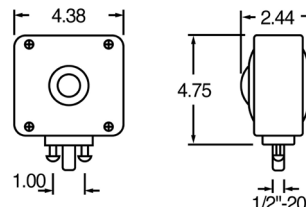

Part Number	Lamp Connector	Plug Side 1	Plug Side 2	Lens Color	Housing Material	Housing Color	Volts	Amps Major/Minor
955	Hardwired	Hardwired	Stripped End	Red Yellow	Zinc	Black	12	2.1/0.5

INCANDESCENT

DUAL FACE

## DUAL FACE, INCANDESCENT, POLYCARBONATE, 3 WIRE, RECTANGULAR, 2 STUD MOUNT



- Combination lamp functions as turn signal, side marker and parking lamp with reflector
- High-impact plastic housing resists rust and corrosion
- Wire harness enclosed in weather proof housing

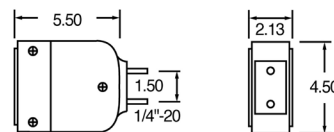

Part Number	Lamp Connector	Plug Side 1	Plug Side 2	Lens Color	Number of Diodes	Housing Color	Volts	Amps Major/Minor
4701	Hardwired	Hardwired	Stripped End	Red Yellow	2	Black	12	2.1/0.5
4702	Hardwired	Hardwired	Stripped End	Red Yellow	2	Black	12	2.1/0.5

INCANDESCENT

DUAL FACE

INCANDESCENT  
DUAL FACE

## DUAL FACE, INCANDESCENT, POLYCARBONATE, 2 WIRE, SQUARE, 1 STUD MOUNT

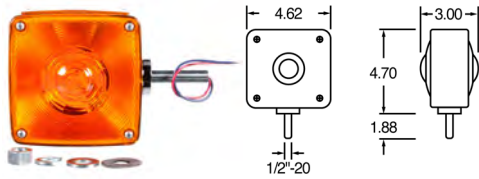

- Black-housed version is a popular Western Star replacement
- Chrome-housed version is a popular replacement for Volvo and Peterbilt
- Combination park, turn, side marker and reflex reflector
- Standard on many OEM applications
- High-impact non-corrosive polycarbonate housing
- Side marker and reflector included in design

Part Number	Lamp Connector	Plug Side 1	Plug Side 2	Lens Color	Number of Bulbs	Housing Color	Volts	Amps Major/Minor
4800	Hardwired	Hardwired	Stripped End	Red Yellow	2	Black	12	2.1/0.5
4801	Hardwired	Hardwired	Stripped End	Red Yellow	2	Chrome	12	2.1/0.5
4810	Hardwired	Hardwired	Stripped End	Red Yellow	2	Black	12	2.1/0.5

INCANDESCENT  
DUAL FACE

## DUAL FACE, INCANDESCENT, POLYCARBONATE, 2 WIRE, SQUARE, 2 STUD MOUNT

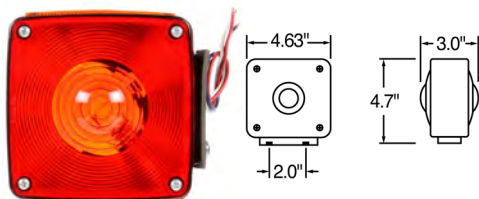

- Ground wire added for use on fiberglass fenders
- High-impact non-corrosive polycarbonate housing
- Mounting pad and two 1/4"-20 bolts included
- Side marker and reflector included in design

Part Number	Lamp Connector	Plug Side 1	Plug Side 2	Lens Color	Number of Bulbs	Housing Color	Volts	Amps Major/Minor
4805	Hardwired	Hardwired	Stripped End	Red Yellow	2	Black	12	2.1/0.5

## DUAL FACE, INCANDESCENT, POLYCARBONATE, 3 WIRE, RECTANGULAR, 2 STUD MOUNT



- 4805AAY115 includes OEM 7" harness that mates with truck harness - simplifying replacement
- 4805AAY118 included 75" OEM mating harness
- Dual-optic lens
- Polycarbonate lens and housing
- Side marker and reflector included in design
- Mounting pad included
- Two 5/16" studs on 2" centers

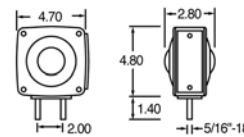

Part Number	Lamp Connector	Plug Side 1	Plug Side 2	Lens Color	Number of Bulbs	Housing Color	Volts	Amps Major/Minor
4805AAY115	Hardwired	Hardwired	Packard 12010996/ Packard 12010973	Yellow	2	Black	12	2.1/0.5
4805AAY118	Hardwired	Hardwired	Packard 12015791/ Packard 12015792	Yellow	2	Black	12	2.1/0.5
4805AY116	Hardwired	Hardwired	Packard 12052457	Red Yellow	2	Chrome	12	2.1/0.5
4805AY117	Hardwired	Hardwired	Packard 12052457	Red Yellow	2	Chrome	12	2.1/0.5
4874AY101	Hardwired	Hardwired	.180 Bullet/ Female .180 Bullet	Yellow	1	Chrome	12	2.1/0.5

## 5800 SERIES, DUAL FACE, INCANDESCENT, POLYCARBONATE, 3 WIRE, RECTANGULAR, 2 STUD MOUNT



- Polycarbonate snap-On/snap-off lens - no screws
- Special Packard Metri-Pack connector
- Combination side marker lamp and reflex reflector lens
- Mounts left or right
- Unbreakable, easy bulb replacement one lens sealed, one lens snaps on/off
- For quick, easy connection that eliminates corrosion
- Isolates the bulb from the jarring effects of road shock and vibration
- For front turn signal, park and side marker
- Eliminates the need for separate side marker lamp and reflex reflector
- Positive lens fit, corrosion proof, watertight
- GM #15565531

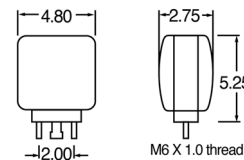

Part Number	Lamp Connector	Plug Side 1	Plug Side 2	Lens Color	Number of Bulbs	Housing Color	Volts	Amps Major/Minor
5800AA	Packard Connector	Packard Connector	Stripped End	Yellow	1	Black	12	2.1/0.59
5800AAK	Packard Connector	Packard Connector	Stripped End	Yellow	1	Black	12	2.1/0.59

# LIGHT MODULES

## LED MODULES

Pages 108-110

SERIES	PAGES
40® Series	108-109
Super 44®	109
Signal-Stat	110

## LED / INCANDESCENT MODULES

Pages 110-112

SERIES	PAGES
40® Series	110
45® Series	111-112

## INCANDESCENT MODULES

Pages 113-117

SERIES	PAGES
40® Series	113-116
Signal-Stat	117

# 40<sup>®</sup> SERIES, LED, STOP/TURN/TAIL

LED

40 SERIES

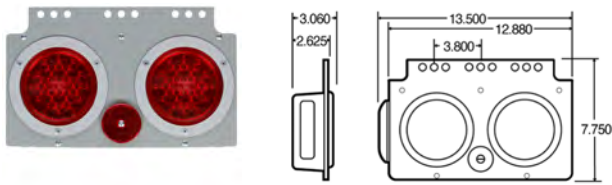

- Features universal mount designed to retrofit a wide variety of vehicles
- Kits include metal mounting box with side marker lamp and reflector
- Optional mounting gasket available to provide extra seal between module and body
- Truck-Lite or Signal-Stat LED lighting modules also available



Part Number	Position	Mount/Trim Color	S/T/T Light Part#	Harness Part#	Harness Part#	Volts
40626	LH	Gray	40626	44222R	50200	12
40627	RH	Gray	40626	44222R	50200	12

## MODULE COMPONENTS

	S/T/T Light Part#	Harness Part#	Harness Part#
Part #	40626	44222R	50200
Quantity	2	1	1

Standards Met	Compliance Family
A I6 P2 S2 T	FMVSS 108 CMVSS 108 DOT SAE

# 40<sup>®</sup> SERIES, LED, STOP/TURN/TAIL | MARKER CLEARANCE

LED

40 SERIES

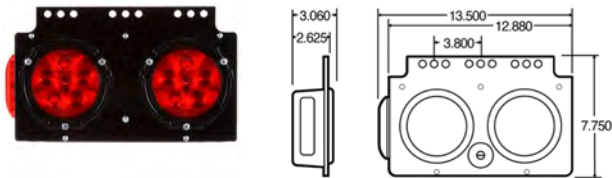

- Features universal mount designed to retrofit a wide variety of vehicles
- Kits include metal mounting box with side marker lamp and reflector
- Optional mounting gasket available to provide extra seal between module and body
- Truck-Lite or Signal-Stat LED lighting modules also available



Part Number	Position	Mount/Trim Color	S/T/T Light Part#	M/C Light Part#	Volts
40637	LH	Black	44326R	19250R	12
40638	RH	Black	44326R	19250R	12

## MODULE COMPONENTS

	S/T/T Light Part#	M/C Light Part#
Part #	44326R	19250R
Quantity	2	1

Standards Met	Compliance Family
A I6 P2 S2 T	FMVSS 108 CMVSS 108 DOT SAE

## 40<sup>®</sup> SERIES, LED, BACK-UP | LICENSE | STOP/TURN/TAIL



- Mounts between frame rail
- Features heavy-gauge metal module
- Comes with pre-assembled junction box with wiring harness
- 40894 features Peterbilt replacement with red LED lamps and excludes junction box

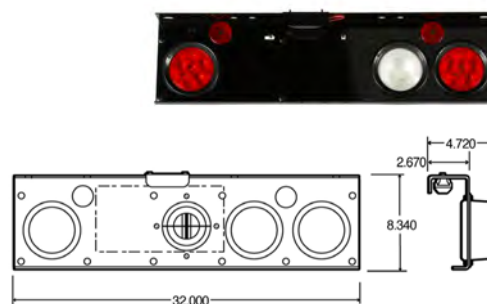

Part Number	Mount/Trim Color	B/U Light Part#	License Light Part#	S/T/T Light Part#	Grommet Part#	Volts
40894	Black	40204	19206	44302R	40700	12

### MODULE COMPONENTS

	B/U Light Part#	License Light Part#	S/T/T Light Part#	Grommet Part#
Part #	40204	19206	44302R	40700
Quantity	1	1	2	3

Standards Met	Compliance Family
S2 I6 A R T	FMVSS 108 CMVSS 108 DOT SAE

## SUPER 44<sup>®</sup>, LED, STOP/TURN/TAIL | BACK-UP | TURN SIGNAL | SIDE MARKER



- Popular on straight truck applications
- Features metal module box with side marker and back-up lamps

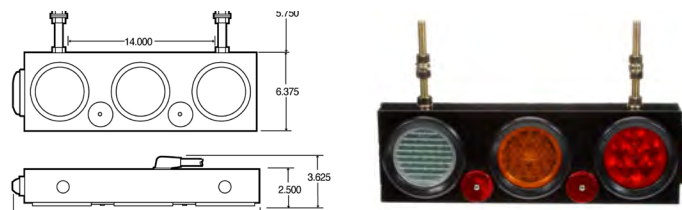

Part Number	Position	Mount/Trim Color	S/T/T Light Part#	Turn Signal Light Part#	B/U Light Part#	M/C Light Part#	Grommet Part#	Volts
44808	RH	Black	44302R	44201Y	44206C	19250R	40700	12
44809	LH	Black	44302R	44201Y	44206C	19250R	40700	12

### MODULE COMPONENTS

	S/T/T Light Part#	Turn Signal Light Part#	B/U Light Part#	M/C Light Part#	Grommet Part#
Part #	44302R	44201Y	44206C	19250R	40700
Quantity	1	1	1	1	3

Standards Met	Compliance Family
A I6 P2 R S2 T	FMVSS 108 CMVSS 108 DOT SAE

LED

SIGNAL-STAT

# SIGNAL-STAT, LED, MARKER CLEARANCE | STOP/TURN/TAIL, KIT



- Features universal mount designed to retrofit a wide variety of vehicles
- Kits include metal mounting box with side marker lamp and reflector
- Optional mounting gasket available to provide extra seal between module and body
- Truck-Lite or Signal-Stat LED lighting modules also available



Part Number	Position	Mount/Trim Color	M/C Light Part#	S/T/T Light Part#	Grommet Part#	Volts
9536	LH	Black	1960	4050	40700	12
9537	RH	Black	1960	4050	40700	12

## MODULE COMPONENTS

Part #	M/C Light Part#	S/T/T Light Part#	Grommet Part#
Part #	1960	4050	40700
Quantity	1	2	2

Standards Met	Compliance Family
A I6 P2 S2 T	FMVSS 108 CMVSS 108 DOT SAE

LED / INCANDESCENT

40 SERIES

# 40<sup>®</sup> SERIES, LED, STOP/TURN/TAIL | BACK-UP | TURN SIGNAL | SIDE MARKER

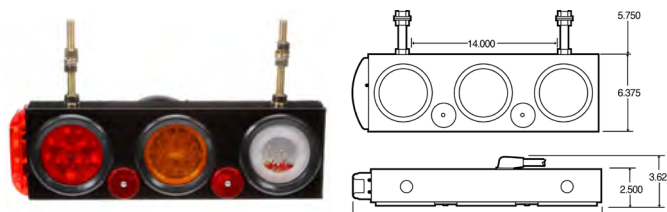

- Popular on straight truck applications
- Features metal module box with side marker and back-up lamps



Part Number	Position	Mount/Trim Color	S/T/T Light Part#	Turn Signal Light Part#	B/U Light Part#	M/C Light Part#	Grommet Part#	Volts
40808	RH	Black	44302R	44201Y	40244	21201R	40700	12
40809	LH	Black	44302R	44201Y	40244	21201R	40700	12

## MODULE COMPONENTS

Part #	S/T/T Light Part#	Turn Signal Light Part#	B/U Light Part#	M/C Light Part#	Grommet Part#
Part #	44302R	44201Y	40244	21201R	40700
Quantity	1	1	1	1	3

Standards Met	Compliance Family
A I6 P2 R S2 T	FMVSS 108 CMVSS 108 DOT SAE



## 45<sup>®</sup> SERIES, LED/INCANDESCENT, STOP/TURN/TAIL | BACK-UP | TURN SIGNAL



- Features weather-resistant synthetic rubber and polypropylene construction
- Three-lamp module includes one each multi-volt LED S/T lamp, LED turn signal lamp and sealed reverse lamp
- Mounts on four studs, each set on 78mm centers, 131mm apart
- Module includes a 1.25m harness

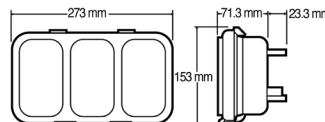

Part Number	Position	Mount/Trim Color	Lamp Connection	Plug Side 1	Plug Side 2	Volts
45420	RH	Black	Hardwired PL-2	PL-2	Blunt Cut	24
45423	LH	Black	Hardwired PL-2	PL-2	Blunt Cut	24
45430	RH	Black	Hardwired PL-2	PL-2	Blunt Cut	12
45433	LH	Black	Hardwired PL-2	PL-2	Blunt Cut	12

Standards Met	Compliance Family
R3 R6 R7 R23	ECE

## 45<sup>®</sup> SERIES, LED/INCANDESCENT, STOP/TURN/TAIL | TURN SIGNAL | REAR FOG LAMP



- Features weather-resistant synthetic rubber and polypropylene construction
- Three-lamp module includes one each multi-volt LED rear position/stop lamp, direction indicator lamp and rear fog lamp
- Mounts on four studs, each set on 78mm centers, 131mm apart
- Module includes a 1.25m harness

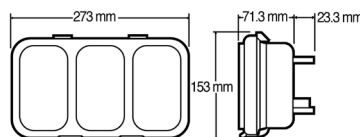

Part Number	Position	Mount/Trim Color	Lamp Connection	Plug Side 1	Plug Side 2	Volts
45421	RH	Black	Hardwired	Hardwired	Blunt Cut	12 24
45422	LH	Black	Hardwired	Hardwired	Blunt Cut	12 24

Standards Met	Compliance Family
R6 R7 R38	ECE

# 45<sup>®</sup> SERIES, LED/INCANDESCENT, STOP/TURN/TAIL | BACK-UP | TURN SIGNAL | REAR FOG LAMP

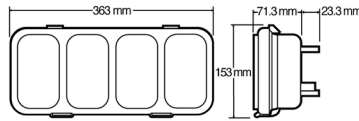

- Features weather-resistant synthetic rubber and polypropylene construction
- Four-lamp module includes one each multi-volt LED rear position/stop lamp, LED direction indicator lamp, LED rear fog lamp and sealed reverse lamp
- Mounts on four studs, each set on 78mm centers, 219mm apart
- Module includes a 1.25m harness



Part Number	Position	Mount/Trim Color	Lamp Connection	Plug Side 1	Plug Side 2	Volts
45626	RH	Black	Hardwired PL-2	PL-2	Blunt Cut	24
45627	LH	Black	Hardwired PL-2	PL-2	Blunt Cut	24

Standards Met	Compliance Family
R3 R6 R7 R23 R38	ECE

Part Number	Position	Mount/Trim Color	Lamp Connection	Plug Side 1	Plug Side 2	Volts
45630	RH	Black	Hardwired PL-2	PL-2	Blunt Cut	12
45631	LH	Black	Hardwired PL-2	PL-2	Blunt Cut	12

Standards Met	Compliance Family
R6 R7 R23	ECE

# 40<sup>®</sup> SERIES, INCANDESCENT, STOP/TURN/TAIL, PVC

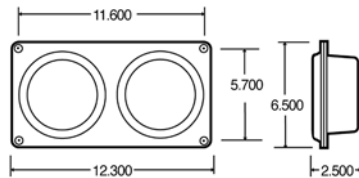

- Features high-impact plastic module box
- Mounts in 11" x 5.12" hole
- Optional mounting gasket available to provide extra seal between module and body



Part Number	Position	Mount/Trim Color	S/T/T Light Part#	Harness	Harness	Grommet	Housing	Volts
40742	LH	Black	40202R	50200	50201	40700	40722	12
40743	RH	Black	40202R	50200	50201	40700	40722	12

## MODULE COMPONENTS

	S/T/T Light Part#	Harness	Harness	Grommet	Housing
Part #	40202R	50200	50201	40700	40722
Quantity	2	1	1	2	1

Standards Met	Compliance Family
P2 S2 I6 T	FMVSS 108 CMVSS 108 DOT SAE

# 40<sup>®</sup> SERIES, INCANDESCENT, STOP/TURN/TAIL, STEEL



- Features metal mounting flange with high-impact plastic module box
- Optional mounting gasket #97938 available to provide extra seal between module and body

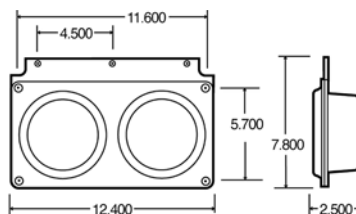

Part Number	Position	Mount/Trim Color	S/T/T Light Part#	Harness	Harness	Grommet	Housing	Flange Mount	Volts
40746	LH	Black	40202R	50200	50201	40700	40722	40721	12
40747	RH	Black	40202R	50200	50201	40700	40722	40721	12

## MODULE COMPONENTS

	S/T/T Light Part#	Harness	Harness	Grommet	Housing	Flange Mount
Part #	40202R	50200	50201	40700	40722	40721
Quantity	2	1	1	2	3	1

Standards Met	Compliance Family
S2 I6 R T	FMVSS 108  CMVSS 108  DOT SAE

# 40<sup>®</sup> SERIES, INCANDESCENT, STOP/TURN/TAIL | TURN SIGNAL | SIDE MARKER, STEEL



- Popular on straight truck applications
- Features metal module box with side marker and turn signal lamps

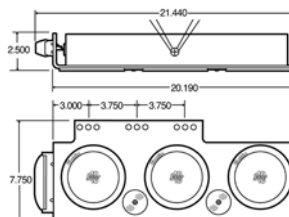

Part Number	Position	Mount/Trim Color	S/T/T Light Part#	Turn Signal Light Part#	M/C Light Part#	Grommet Part#	Volts
40762	LH	Black	40242R	40241Y	19200R	40700	12
40763	RH	Black	40242R	40241Y	19200R	40700	12

## MODULE COMPONENTS

	S/T/T Light Part#	Turn Signal Light Part#	M/C Light Part#	Grommet Part#
Part #	40242R	40241Y	19200R	40700
Quantity	2	1	1	3

Standards Met	Compliance Family
I6 A P2 T	FMVSS 108 CMVSS 108  DOT SAE

# 40® SERIES, INCANDESCENT, STOP/TURN/TAIL | MARKER CLEARANCE | SIDE MARKER

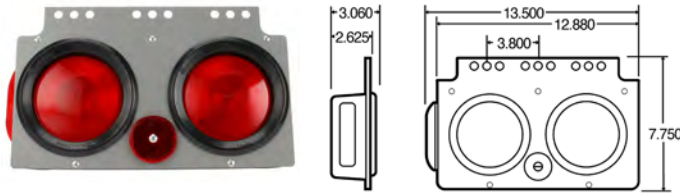

- Features universal mount designed to retrofit a wide variety of vehicles
- Kits include metal mounting box with side marker lamp and reflector
- Optional mounting gasket available to provide extra seal between module and body
- Truck-Lite or Signal-Stat LED lighting modules also available



Part Number	Position	Mount/Trim Color	S/T/T Light Part#	M/C Light Part#	Grommet	Volts
40756	LH	Black	40202R	19200R	40700	12
40757	RH	Black	40202R	19200R	40700	12

## MODULE COMPONENTS

Part #	S/T/T Light Part#	M/C Light Part#	Grommet
Quantity	2	1	2

Standards Met	Compliance Family
A I6 P2 S2 T	FMVSS 108 CMVSS 108 DOT SAE

# 40® SERIES, INCANDESCENT, STOP/TURN/TAIL | BACK-UP | TURN SIGNAL | SIDE MARKER

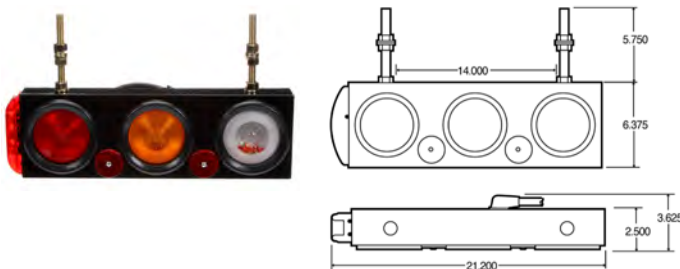

- Popular on straight truck applications
- Features metal module box with side marker and back-up lamps
- Upgrade to LED lighting system, use part #40808 and 40809



Part Number	Position	Mount/Trim Color	S/T/T Light Part#	Turn Signal Light Part#	B/U Light Part#	M/C Light Part#	Grommet	Volts
40790	RH	Black	40242R	40241Y	40244	21201R	40700	12
40791	LH	Black	40242R	40241Y	40244	21201R	40700	12

## MODULE COMPONENTS

Part #	S/T/T Light Part#	Turn Signal Light Part#	B/U Light Part#	M/C Light Part#	Grommet
Quantity	1	1	1	1	3

Standards Met	Compliance Family
A I6 P2 R S2 T	FMVSS 108 CMVSS 108 DOT SAE

# 40<sup>®</sup> SERIES, INCANDESCENT, STOP/TURN/TAIL | BACK-UP | SIDE MARKER



- Popular on straight truck applications
- Features metal module box with side marker and back-up lamps

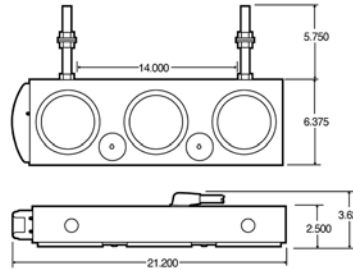

Part Number	Position	Mount/Trim Color	Lamp Connection	Plug Side 1	Plug Side 2	Volts
40758	LH	Black	PL-2	PL-2	Ring Terminal	12
40759	RH	Black	PL-2	PL-2	Ring Terminal	12

## REPLACEMENT PARTS / KIT COMPONENTS

Module Part#	S/T/T Light Part#	B/U Light Part#	M/C Light Part#	Grommet
40758	40242R	40244	21201R	40700
40759	40242R	40244	21201R	40700

Standards Met	Compliance Family
A I6 P2 R S2 T	FMVSS 108 CMVSS 108 DOT SAE

# 40<sup>®</sup> SERIES, INCANDESCENT, STOP/TURN/TAIL | BACK-UP | LICENSE



- Mounts between frame rail
- Features heavy-gauge metal module
- Comes with pre-assembled junction box with wiring harness

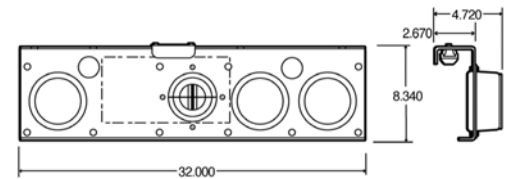

Part Number	Mount/Trim Color	S/T/T Light Part#	B/U Light Part#	License Light Part#	Grommet	Volts
40850	Black	40242R	40204	19206	40700	12

## MODULE COMPONENTS

	S/T/T Light Part#	B/U Light Part#	License Light Part#	Grommet
Part #	40242R	40204	19206	40700
Quantity	2	1	1	3

Standards Met	Compliance Family
A I6 P2 R S2 T	FMVSS 108 CMVSS 108 DOT SAE

# 40<sup>®</sup> SERIES, INCANDESCENT, STOP/TURN/TAIL | BACK-UP, KIT

INCANDESCENT

40 SERIES

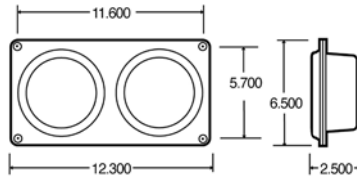

- Features high-impact plastic module box
- Mounts in 11" x 5.12" hole
- Optional mounting gasket available to provide extra seal between module and body



Part Number	Position	Mount/Trim Color	S/T/T Light Part#	B/U Light Part#	Harness	Housing	Grommet	Volts
40748	LH	Black	40242R	40244	50201	40722	40700	12
40749	RH	Black	40242R	40244	50201	40722	40700	12

## MODULE COMPONENTS

Part #	S/T/T Light Part#	B/U Light Part#	Harness	Housing	Grommet
Part #	40242R	40244	50201	40722	40700
Quantity	1	1	1	1	2

Standards Met	Compliance Family
P2 S2 I6 T	FMVSS 108 CMVSS 108 DOT SAE

# 40<sup>®</sup> SERIES, INCANDESCENT, STOP/TURN/TAIL | BACK-UP, KIT

INCANDESCENT

40 SERIES

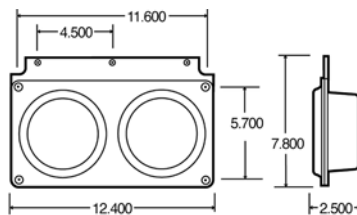

- Features metal mounting flange with high-impact plastic module box
- Optional mounting gasket #97938 available to provide extra seal between module and body



Part Number	Position	Mount/Trim Color	S/T/T Light Part#	B/U Light Part#	Harness	Flange Mount	Housing	Grommet	Volts
40754	LH	Black	40242R	40244	50201	40721	40722	40700	12
40755	RH	Black	40242R	40244	50201	40721	40722	40700	12

## MODULE COMPONENTS

Part #	S/T/T Light Part#	B/U Light Part#	Harness	Flange Mount	Housing	Grommet
Part #	40242R	40244	50201	40721	40722	40700
Quantity	1	1	1	1	1	2

Standards Met	Compliance Family
S2 I6 R T	FMVSS 108 CMVSS 108 DOT SAE

# SIGNAL-STAT, INCANDESCENT, STOP/TURN/TAIL | BACK-UP



- Unique housing offers shock absorbency and allows lamp replacement without tools
- Features rugged thermoplastic rubber housing
- High-impact polypropylene cover
- Pre-wired terminal contact strip included

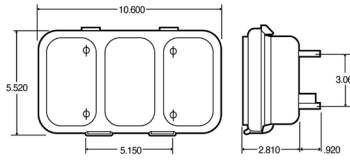

Part Number	Position	Mount/Trim Color	S/T/T Light Part#	B/U Light Part#	Housing	Cover	Volts
45740	LH	Black	45202R	45204	45323	45333	12
45741	RH	Black	45202R	45204	45323	45333	12

## MODULE COMPONENTS

	S/T/T Light Part#	B/U Light Part#	Housing	Cover
Part #	45202R	45204	45323	45333
Quantity	2	1	1	1

Standards Met	Compliance Family
P2 S2 I6 R A T	FMVSS 108 CMVSS 108 DOT SAE

# SIGNAL-STAT, INCANDESCENT, STOP/TURN/TAIL | BACK-UP | TURN SIGNAL



- Unique housing offers shock absorbency and allows lamp replacement without tools
- Features rugged thermoplastic rubber housing
- High-impact polypropylene cover
- Pre-wired terminal contact strip included

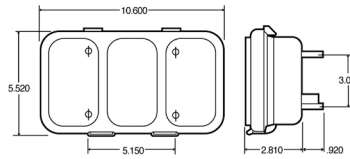

Part Number	Position	Mount/Trim Color	S/T/T Light Part#	B/U Light Part#	Turn Signal Light Part#	Housing	Cover	Volts
45742	LH	Black	45202R	45204	45201Y	45323	45333	12
45743	RH	Black	45202R	45204	45201Y	45323	45333	12

## MODULE COMPONENTS

	S/T/T Light Part#	B/U Light Part#	Turn Signal Light Part#	Housing	Cover
Part #	45202R	45204	45201Y	45323	45333
Quantity	1	1	1	1	1

Standards Met	Compliance Family
P2 S2 I6 R A T	FMVSS 108 CMVSS 108 DOT SAE

INCANDESCENT

SIGNAL-STAT

INCANDESCENT

SIGNAL-STAT

# **ATTENTION!**

**For Signal-Stat Marker & Clearance products, see addendum on page 585.**

# **MARKER & CLEARANCE LIGHTS**



## LED LIGHTS

Pages 122-144

SERIES	COMMON SIZE	PAGES
10® Series	2.5"	122-126
12® Series	2" x 3"	126
15® Series	1" x 2"	126-127
18® Series	2" x 5"	128
19® Series	1" x 4"	129-130
21® Series	2" x 6"	130-132
25® Series	2" x 5"	132-133
26 Series	2" x 5"	134
30® Series	2"	134-140
33® Series	0.75"	140-142
35® Series	1" x 4"	143
36 Series	1" x 2"	144

## INCANDESCENT LIGHTS

Pages 145-163

SERIES	COMMON SIZE	PAGES
10® Series	2" x 5"	145-146
Super 10® Series	2" x 5"	147
12® Series	2" x 3"	148
13 Series	2" x 4"	149
14 Series	2" x 3"	150
15® Series	1" x 2"	150-151
18® Series	2" x 5"	151
19® Series	1" x 4"	152
21® Series	2" x 6"	153-154
Super 21® Series	2" x 6"	154-156
25® Series	Multiple	156-157
26 Series	Multiple	158-160
30® Series	2"	161-163
60® Series	2" x 6"	163





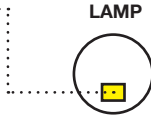
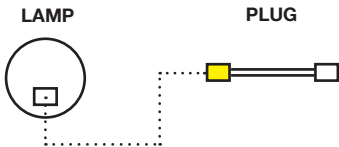
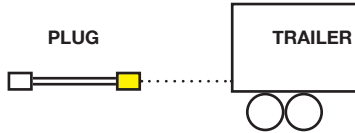

# Marker/Clearance Lighting

Truck-Lite's LED marker and clearance lighting is designed to exceed legal requirements when correctly mounted. A variety of styles and mounting options allow for easy customization and provide the safety and visibility that you've come to expect from Truck-Lite.

<p><b>Shapes</b></p>	<p>Round, Oval, Rectangular, Triangular, Beehive, Winged</p>
<p><b>Mount Types</b></p>	<p>Grommet, Flange, Bracket, 2 Screw, 4 Screw, Adhesive, 2 Bolt, 1 Stud, 2 Stud</p>
<p><b>Connection Information</b></p> <p>When it comes to choosing the correct lamps for your truck or trailer, it's important to know the connection type on your vehicle's harness.</p> <p>If the harness connector type does not match your desired light (lamp connector), you will need a plug to complete the connection.</p>	<p><b>Lamp Connector</b></p> <p>The connector type located on the back of a lamp</p>  <p><b>Plug Side 1</b></p> <p>The connection between a plug and a lamp</p>  <p><b>Plug Side 2</b></p> <p>The connection between a plug and a trailer's harness</p> 

(800) 562-5012 | [truck-lite.com](http://truck-lite.com)

 <p><b>Manufacturing &amp; Quality</b></p>	 <p><b>Testing &amp; Safety</b></p>
<p>Truck-Lite's LED marker/clearance lighting is built using premium materials and backed by industry-leading warranties. Designed to last the life of your vehicle, Truck-Lite's solid-state construction and sealed circuitry mean that you can depend on your lighting to withstand shock, vibration, moisture and debris.</p>	<p>All Truck-Lite lamps are subjected to rigorous environmental, electrical and mechanical testing before they are validated and released to the market.</p> <p>All lamps comply with FMVSS/CMVSS-108, SAE and DOT standards when properly mounted.</p>
 <p><b>Performance &amp; Maintenance</b></p>	 <p><b>Customer Support</b></p>
<ul style="list-style-type: none"> <li>• Lower energy consumption, allowing more power for other vehicle requirements</li> <li>• Impact-resistant lenses and rugged housing protect against damage from even the toughest applications</li> <li>• Sealed electronics resist damage caused by moisture and corrosion</li> <li>• Reduced lighting costs associated with physical damage and heat entrapment</li> </ul>	<p><b>Customer Service</b></p> <p>(800) 562-5012 customerservice@truck-lite.com</p> <p><b>Technical Support</b></p> <p>(888) 562-5012 tltech@truck-lite.com</p> <p><b>Marker &amp; Clearance Warranties</b></p> 
<p>(800) 562-5012   truck-lite.com</p>	

# 10<sup>®</sup> SERIES, LED, GROMMET MOUNT



- Most advanced and cost-effective 2-1/2" clearance and marker lamp
- Completely sealed electronics resist corrosion and moisture
- Less current draw, resulting in increased battery and alternator life while allowing more power for other vehicle requirements
- Polycarbonate lens

Part Number	Lens Color	Lamp Connector	Volts	Amps	Diodes	Lighting Codes	Warranty
10250R	Red	Fit 'N Forget M/C	12	0.03	2	P2, PC	LIFETIME
10250Y	Yellow	Fit 'N Forget M/C	12	0.08	2	P2	LIFETIME
10256R	Red	Fit 'N Forget M/C	12 24	0.05	3	P2, PC	LIFETIME
10256Y	Yellow	Fit 'N Forget M/C	12 24	0.05	3	P2, PC	LIFETIME
10275R	Red	PL-10	12	0.1	8	P2, P3, PC	3-year
10275Y	Yellow	PL-10	12	0.1	8	P2, P3, PC	3-year
10286R	Red	PL-10	12	0.1	8	P2, PC	3-year
10286Y	Yellow	PL-10	12	0.1	8	P2, PC	3-year
10375R	Red	Fit 'N Forget M/C	12	0.1	8	P2, P3, PC	LIFETIME
10375Y	Yellow	Fit 'N Forget M/C	12	0.1	8	P2, P3, PC	LIFETIME
10385R	Red	Fit 'N Forget M/C	12	0.1	8	P2, PC	LIFETIME
10385Y	Yellow	Fit 'N Forget M/C	12	0.1	8	P2, PC	LIFETIME

# 10<sup>®</sup> SERIES, LED, GROMMET MOUNT, KIT

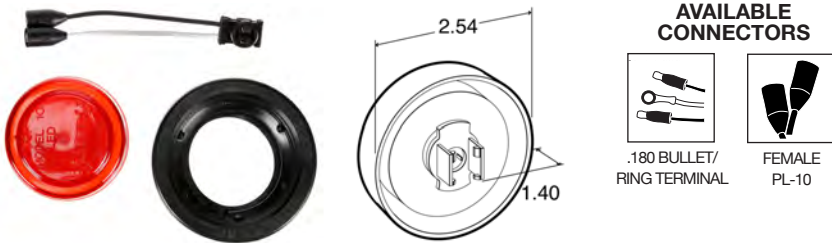

- Most advanced and cost-effective 2-1/2" clearance and marker lamp
- Completely sealed electronics resist corrosion and moisture
- Less current draw, resulting in increased battery and alternator life while allowing more power for other vehicle requirements
- Polycarbonate lens

Part Number	Lens Color	Lamp Connector	Plug Side 1	Plug Side 2	Volts	Amps	Diodes	Lighting Codes	Warranty
10050R	Red	Fit 'N Forget M/C	Fit 'N Forget M/C	Female PL-10	12	0.03	2	P2, PC	LIFETIME
10050Y	Yellow	Fit 'N Forget M/C	Fit 'N Forget M/C	Female PL-10	12	0.08	2	P2, PC	LIFETIME
10075R	Red	PL-10	PL-10	.180 Bullet/Ring Terminal	12	0.1	8	P2, P3, PC	3-year
10075Y	Yellow	PL-10	PL-10	.180 Bullet/Ring Terminal	12	0.1	8	P2, P3, PC	3-year
10076R	Red	Fit 'N Forget M/C	Fit 'N Forget M/C	Female PL-10	12	0.1	8	P2, P3, PC	LIFETIME
10076Y	Yellow	Fit 'N Forget M/C	Fit 'N Forget M/C	Female PL-10	12	0.1	8	P2, P3, PC	LIFETIME
10085R	Red	Fit 'N Forget M/C	Fit 'N Forget M/C	Female PL-10	12	0.1	8	P2, P3, PC	LIFETIME
10085Y	Yellow	Fit 'N Forget M/C	Fit 'N Forget M/C	Female PL-10	12	0.1	8	P2, P3, PC	LIFETIME
10086R	Red	PL-10	PL-10	.180 Bullet/Ring Terminal	12	0.1	8	P2, PC	3-year
10086Y	Yellow	PL-10	PL-10	.180 Bullet/Ring Terminal	12	0.1	8	P2, PC	3-year

LED

10 SERIES

LED

10 SERIES

## 10<sup>®</sup> SERIES, LED, ROUND, FLANGE MOUNT

- Most advanced and cost effective 2-1/2" clearance and marker lamp
- Completely sealed electronics resist corrosion and moisture
- Less current draw, resulting in increased battery and alternator life while allowing more power for other vehicle requirements
- Electronics completely sealed in epoxy to resist corrosion and moisture
- Polycarbonate lens

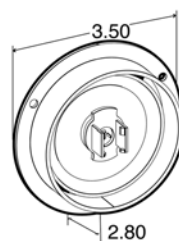

Part Number	Lens Color	Mount Color	Lamp Connector	Volts	Amps	Diodes	Lighting Codes	Warranty
10251R	Red	Gray	Fit 'N Forget M/C	12	0.03	2	P2, PC	LIFETIME
10251Y	Yellow	Gray	Fit 'N Forget M/C	12	0.08	2	P2, PC	LIFETIME
10271Y	Yellow	Gray	Fit 'N Forget M/C	12	0.08	2	P2, PC	LIFETIME
10279R	Red	Gray	PL-10	12	0.1	8	P2, P3, PC	3-year
10279Y	Yellow	Gray	PL-10	12	0.1	8	P2, P3, PC	3-year
10379R	Red	Gray	Fit 'N Forget M/C	12	0.1	8	P2, P3, PC	LIFETIME
10379Y	Yellow	Gray	Fit 'N Forget M/C	12	0.1	8	P2, P3, PC	LIFETIME

## 10<sup>®</sup> SERIES, LED, ROUND, FLANGE MOUNT, KIT



- Most advanced and cost-effective 2-1/2" clearance and marker lamp
- Completely sealed electronics resist corrosion and moisture
- Polycarbonate lens

### AVAILABLE CONNECTORS



.180 BULLET/  
RING TERMINAL



FEMALE  
PL-10

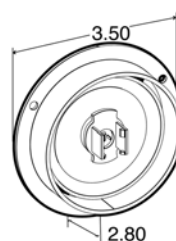

Part Number	Lens Color	Mount Color	Lamp Connector	Plug Side 1	Plug Side 2	Volts	Amps	Diodes	Lighting Codes	Warranty
10051R	Red	Gray	Fit 'N Forget M/C	Fit 'N Forget M/C	Female PL-10	12	0.03	2	P2, PC	LIFETIME
10051Y	Yellow	Gray	Fit 'N Forget M/C	Fit 'N Forget M/C	Female PL-10	12	0.08	2	P2, PC	LIFETIME
10079R	Red	Gray	PL-10	PL-10	.180 Bullet/ Ring Terminal	12	0.1	8	P2, P3, PC	3-year
10079Y	Yellow	Gray	PL-10	PL-10	.180 Bullet/ Ring Terminal	12	0.1	8	P2, P3, PC	3-year
10089R	Red	Gray	PL-10	PL-10	.180 Bullet/ Ring Terminal	12	0.1	8	P2, PC	3-year
10090R	Red	Gray	Fit 'N Forget M/C	Fit 'N Forget M/C	Female PL-10	12	0.1	8	P2, P3, PC	LIFETIME
10090Y	Yellow	Gray	Fit 'N Forget M/C	Fit 'N Forget M/C	Female PL-10	12	0.1	8	P2, P3, PC	LIFETIME
10289R	Red	Gray	PL-10	PL-10	.180 Bullet/ Ring Terminal	12	0.1	8	P2, PC	3-year

### PARTS INCLUDED IN KITS ABOVE

KIT #	Included Parts
10051R	10251r light, 93745 plug
10051Y	10251y light, 93745 plug
10079R	10279r light, 94964 plug

KIT #	Included Parts
10079Y	10279y light, 94964 plug
10089R	10289r light, 94964 plug
10090R	10379r light, 93745 plug

KIT #	Included Parts
10090Y	10379y light, 93745 plug

## 10<sup>®</sup> SERIES, LED, ROUND, FLUSH MOUNT

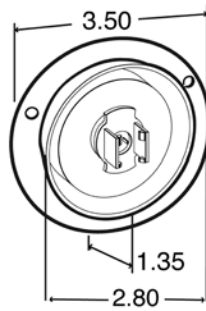

- Most advanced and cost-effective 2-1/2" clearance and marker lamp
- Completely sealed electronics resist corrosion and moisture
- Less current draw, resulting in increased battery and alternator life while allowing more power for other vehicle requirements
- Electronics completely sealed in epoxy to resist corrosion and moisture
- Polycarbonate lens

Part Number	Lens Color	Mount Color	Lamp Connector	Volts	Amps	Diodes	Lighting Codes	Warranty
10288Y	Yellow	Black	PL-10	12	0.1	8	P2, PC	3-year
10289Y	Yellow	Gray	PL-10	12	0.1	8	P2, PC	3-year
10389R	Red	Gray	Fit 'N Forget M/C	12	0.1	8	P2, PC	LIFETIME
10389Y	Yellow	Gray	Fit 'N Forget M/C	12	0.1	8	P2, PC	LIFETIME
10391R	Red	Black	Fit 'N Forget M/C	12	0.1	8	P2, PC	LIFETIME
10391Y	Yellow	Black	Fit 'N Forget M/C	12	0.1	8	P2, PC	LIFETIME

# Looking for even more product information?

Visit [truck-lite.com](http://truck-lite.com)



**Powerful Search  
Function**



**360° Product  
Images**



**Easy-To-Find  
Replacement  
Parts**

# 10<sup>®</sup> SERIES, LED, ROUND, FLUSH MOUNT, KIT



- Most advanced and cost-effective 2-1/2" clearance and marker lamp
- Completely sealed electronics resist corrosion and moisture
- Less current draw, resulting in increased battery and alternator life while allowing more power for other vehicle requirements
- Electronics completely sealed in epoxy to resist corrosion and moisture
- Polycarbonate lens

## AVAILABLE CONNECTORS



.180 BULLET/  
RING TERMINAL



FEMALE  
PL-10

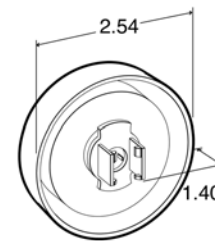

Part Number	Lens Color	Mount Color	Lamp Connector	Plug Side 1	Plug Side 2	Volts	Amps	Diodes	Lighting Codes	Warranty
10089Y	Yellow	Gray	PL-10	PL-10	.180 Bullet/ Ring Terminal	12	0.1	8	P2, PC	3-year
10091R	Red	Gray	Fit 'N Forget M/C	Fit 'N Forget M/C	Female PL-10	12	0.1	8	P2, PC	LIFETIME
10091Y	Yellow	Gray	Fit 'N Forget M/C	Fit 'N Forget M/C	Female PL-10	12	0.1	8	P2, PC	LIFETIME
10092R	Red	Black	Fit 'N Forget M/C	Fit 'N Forget M/C	Female PL-10	12	0.1	8	P2, PC	LIFETIME
10092Y	Yellow	Black	Fit 'N Forget M/C	Fit 'N Forget M/C	Female PL-10	12	0.1	8	P2, PC	LIFETIME
10288R	Red	Black	PL-10	PL-10	.180 Bullet/ Ring Terminal	12	0.1	8	P2, PC	3-year

## PARTS INCLUDED IN KITS ABOVE

KIT #	Included Parts
10089Y	10289Y light, 94964 plug
10091R	10389Y light, 93745 plug
10091Y	10389Y light, 93745 plug

KIT #	Included Parts
10092R	10391R light, 93745 plug
10092Y	10391Y light, 93745 plug



## Quick Tip: Plug Side 1 vs. Plug Side 2

When buying a plug for your light it's important to understand what type of connection mates with the light and what type of termination will mate with the power harness. Plug Side 1 refers to the side of the plug that mates directly to the light. Plug Side 2 refers to the end of the plug that will mate with the power source.



## 10<sup>®</sup> SERIES, LED, GROMMET MOUNT, BEEHIVE



- Popular replacement for cab marker or corner trailer applications
- Meets SAE 592E standards
- Less current draw, resulting in increased battery and alternator life while allowing more power for other vehicle requirements
- LEDs have no filament, therefore are not susceptible to shock and vibration
- Not recommended for use with cam-on mounts
- Polycarbonate lens

Part Number	Lens Color	Lamp Connector	Volts	Amps	Diodes	Lighting Codes	Warranty
10276R	Red	PL-10	12	0.05	8	P2	3-year
10276Y	Yellow	PL-10	12	0.05	8	P2	3-year

## 12<sup>®</sup> SERIES, LED, GROMMET MOUNT



- SAE PC-rated for combination clearance/marker applications
- Snap-in lamp makes installation fast and easy
- Lamp gasket #97921 required for proper lamp and bracket fit
- Polycarbonate lens

Part Number	Lens Color	Lamp Connector	Volts	Amps	Diodes	Lighting Codes	Warranty
12275R	Red	PL-10	12	0.12	6	P2, PC	3 year
12275Y	Yellow	PL-10	12	0.12	6	P2, PC	3 year

## 15<sup>®</sup> SERIES, LED, BRACKET MOUNT

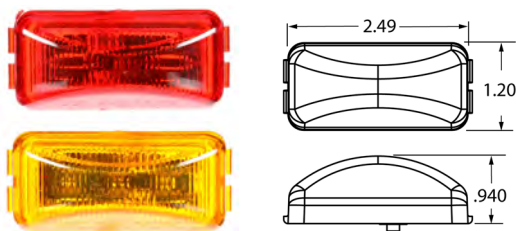

- Designed to fit applications requiring minimal space
- Less susceptible to shock and vibration
- Uses standard mounting holes and accessories
- Not suitable for PC applications
- Draws less current, allowing more power for other vehicle requirements
- Direct pin-to-circuit board solders assure vibration-resistant contacts
- Polycarbonate lens

Part Number	Lens Color	Lamp Connector	Volts	Amps	Diodes	Lighting Codes	Warranty
15250R	Red	PL-10	12	0.05	1	P2, P3	3 year
15250Y	Yellow	PL-10	12	0.05	3	P2, P3	3 year

LED

10 SERIES

LED

12 SERIES

LED

15 SERIES



## 15<sup>®</sup> SERIES, LED, BRACKET MOUNT, KIT



- Sure contact, self-grounding feature
- Submersible for marine use
- Polycarbonate lens

### AVAILABLE CONNECTORS

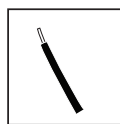

STRIPPED END

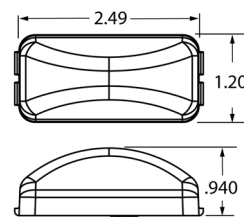

Part Number	Lens Color	Mount Color	Lamp Connector	Plug Side 1	Plug Side 2	Volts	Amps	Diodes	Lighting Codes	Warranty
15033R	Red	Chrome	.156 Bullet Hot Wire	.156 Bullet Hot Wire	Stripped End	12	0.05	1	P2, PC	3 year
15033Y	Yellow	Chrome	.156 Bullet Hot Wire	.156 Bullet Hot Wire	Stripped End	12	0.05	3	P2, PC	3 year

### PARTS INCLUDED IN KITS ABOVE

KIT #	Included Parts
15033R	15250R light, 793 bracket, 96904 wire
15033Y	15250Y light, 793 bracket, 96904 wire

## 15<sup>®</sup> SERIES, LED, BRACKET MOUNT, DUAL FACE, KIT



- Designed for use on most utility trailer fenders
- Wire cover is marked in 1/2" increments for easy length modifications
- Polycarbonate lens

### AVAILABLE CONNECTORS

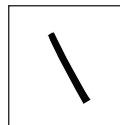

BLUNT CUT

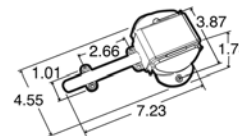

Part Number	Position	Lens Color	Mount Color	Lamp Connector	Plug Side 1	Plug Side 2	Volts	Amps	Diodes	Lighting Codes	Warranty
15417	LH	Red Yellow	Black	PL-10	PL-10	Blunt Cut	12	0.05	4	P2, PC	3 year
15418	RH	Red Yellow	Black	PL-10	PL-10	Blunt Cut	12	0.05	4	P2, PC	3 year

### PARTS INCLUDED IN KITS ABOVE

KIT #	Included Parts
15417	15250R light, 15731 bracket mount
15418	15250Y light, 15731 bracket mount

## 18<sup>®</sup> SERIES, LED, 2 SCREW BRACKET MOUNT, REFLECTORIZED, KIT

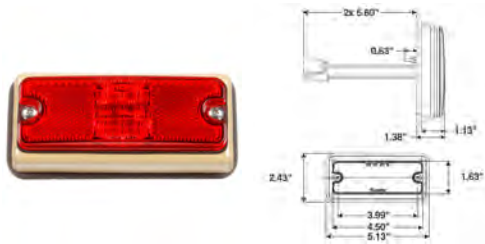

- Complies with SAE J592 and J594 when mounted horizontally
- Brackets utilize standard military color scheme
- Complies with SAE J592 when mounted horizontally between 0 degrees to 34 degrees rollback
- Omnivolt Technology (12 or 24 volt systems will run without adjustment)
- LED life surpasses the 2,000 hours of incandescent bulbs by nearly 50x
- Lens and housing assemblies constructed of impact-resistant polycarbonate
- All electronics fully sealed in epoxy, making lamps less susceptible to shock and vibration
- Faster start-up times and low current draw



Part Number	Lens Color	Mount Color	Lamp Connector	Plug Side 1	Plug Side 2	Volts	Amps	Diodes	Lighting Codes	Warranty
18088R	Red	Tan	Hardwired	Hardwired	Female Military Boot/Ring Terminal	12 24	0.03	3	A P2	1-year
18088Y	Yellow	Tan	Hardwired	Hardwired	Female Military Boot/Ring Terminal	12 24	0.03	3	A P2	1-year
18085R	Red	Green	Hardwired	Hardwired	Female Military Boot/Ring Terminal	12 24	0.05	3	A P2	LIFETIME
18085Y	Yellow	Green	Hardwired	Hardwired	Female Military Boot/Ring Terminal	12 24	0.05	3	A P2	LIFETIME

## 18<sup>®</sup> SERIES, LED, 2 SCREW, REFLECTORIZED, KIT

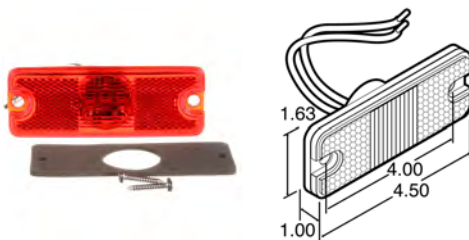

- Uses standard mounting holes and accessories
- Draws less current, allowing more power for other vehicle requirements
- OmniVolt versions also meet ECE standards
- Not suitable for PC requirements
- OmniVolt versions address increasing vehicle power demands by operating equally in electrical systems ranging from 10 to 30 volts
- Meets SAE J592e standards
- Meets SAE J594f when mounted with no rollout or rollback

Part Number	Lens Color	Mount Color	Lamp Connector	Plug Side 1	Plug Side 2	Volts	Amps	Diodes	Lighting Codes	Warranty
18011C	Clear	Clear	Hardwired	Hardwired	Blunt Cut	12 24	0.02	3	E1	3-year
18011R	Red	Red	Hardwired	Hardwired	Blunt Cut	12 24	0.02	3	A P2	3-year
18011Y	Yellow	Yellow	Hardwired	Hardwired	Blunt Cut	12 24	0.02	3	A P2	3-year
18050R	Red	Red	Hardwired	Hardwired	Blunt Cut	12	0.05	3	A P2	3-year
18050Y	Yellow	Yellow	Hardwired	Hardwired	Blunt Cut	12	0.05	3	A P2	3-year
18060R	Red	Red	Hardwired	Hardwired	Packard 12010973	12	0.05	3	A P2	LIFETIME
18060Y	Yellow	Yellow	Hardwired	Hardwired	Packard 12010973	12	0.05	3	A P2	LIFETIME
18070R	Red	Red	Hardwired	Hardwired	Weather 12010972	12	0.05	3	A P2	LIFETIME
18070Y	Yellow	Yellow	Hardwired	Hardwired	Weather 12010972	12	0.05	3	A P2	LIFETIME
18090R	Red	Red	Hardwired	Hardwired	Blunt Cut	12	0.05	3	A P2	3-year
18090Y	Yellow	Yellow	Hardwired	Hardwired	Blunt Cut	12	0.05	3	A P2	3-year

## 19<sup>®</sup> SERIES, LED, BRACKET MOUNT

- Innovative optic design allows combination lamp to function as two
- Draws less current, allowing more power for other vehicle requirements
- Designed to fit applications requiring minimal space
- Must be mounted horizontally
- PC-rated lamps meets requirements when mounted on a 45 degree angle
- Standard red lamps have 2-diode pattern
- PC-rated red lamps and standard yellow lamps have 4-diode pattern
- PC-rated yellow lamps have 6-diode pattern

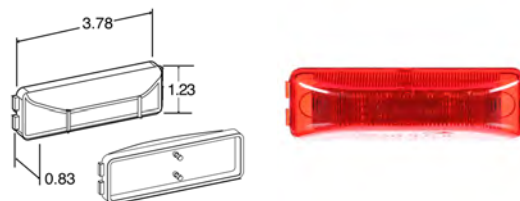

Part Number	Lens Color	Lamp Connector	Volts	Amps	Diodes	Lighting Codes	Warranty
19250R	Red	19 Series Male Pin	12	0.05	2	P2 PC	3-year
19250Y	Yellow	19 Series Male Pin	12	0.05	4	P2 PC	3-year
19251R	Clear   Red	19 Series Male Pin	12	0.05	2	P2 PC	3-year
19251Y	Clear   Yellow	19 Series Male Pin	12	0.05	6	P2 PC	3-year
19275R	Red	19 Series Male Pin	12	0.05	4	P2 PC	3-year
19275Y	Yellow	19 Series Male Pin	12	0.12	6	P2 PC	3-year
19350R	Red	Fit 'N Forget M/C	12	0.05	2	P2 PC	LIFETIME
19350Y	Yellow	Fit 'N Forget M/C	12	0.05	6	P2 PC	LIFETIME
19375R	Red	Fit 'N Forget M/C	12	0.05	4	P2 PC	LIFETIME
19375Y	Yellow	Fit 'N Forget M/C	12	0.12	6	P2 PC	LIFETIME

## 19<sup>®</sup> SERIES, LED, BRACKET MOUNT, REFLECTORIZED, KIT



- Popular in trailer and body applications
- Features unique plug-in design for ease of installation
- Must be mounted horizontally
- Low-profile, extra strength base

### AVAILABLE CONNECTORS

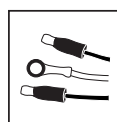

.180 BULLET/  
RING TERMINAL

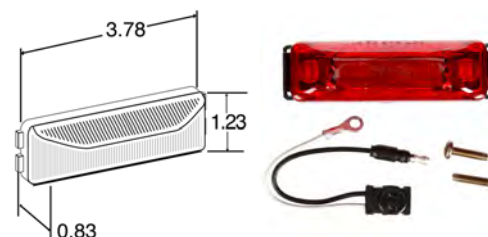

Part Number	Lens Color	Mount Color	Lamp Connector	Plug Side 1	Plug Side 2	Volts	Amps	Diodes	Lighting Codes	Warranty
19031R	Red	Chrome	Fit 'N Forget M/C	Fit 'N Forget M/C	.180 Bullet/ Ring Terminal	12	0.05	2	P2 PC	LIFETIME
19031Y	Yellow	Chrome	Fit 'N Forget M/C	Fit 'N Forget M/C	.180 Bullet/ Ring Terminal	12	0.05	4	P2 PC	LIFETIME
19032R	Red	Black	Fit 'N Forget M/C	Fit 'N Forget M/C	.180 Bullet/ Ring Terminal	12	0.05	2	P2 PC	LIFETIME
19032Y	Yellow	Black	Fit 'N Forget M/C	Fit 'N Forget M/C	.180 Bullet/ Ring Terminal	12	0.05	4	P2 PC	LIFETIME
19036R	Red	Chrome	Fit 'N Forget M/C	Fit 'N Forget M/C	.180 Bullet/ Ring Terminal	12	0.05	4	P2 PC	LIFETIME
19036Y	Yellow	Chrome	Fit 'N Forget M/C	Fit 'N Forget M/C	.180 Bullet/ Ring Terminal	12	0.09	6	P2 PC	LIFETIME
19037R	Red	Black	Fit 'N Forget M/C	Fit 'N Forget M/C	.180 Bullet/ Ring Terminal	12	0.05	4	P2 PC	LIFETIME
19037Y	Yellow	Black	Fit 'N Forget M/C	Fit 'N Forget M/C	.180 Bullet/ Ring Terminal	12	0.09	6	P2 PC	LIFETIME

### PARTS INCLUDED IN KITS ABOVE

KIT #	Included Parts
19006R	19250R light, 19721 bracket
19006Y	19250Y light, 19721 bracket
19020R	19275R light, 19721 bracket
19020Y	19275Y light, 19721 bracket

KIT #	Included Parts
19031R	19350R light, 19748 bracket, 94718 plug
19031Y	19350R light, 19748 bracket, 94718 plug
19032R	19350R light, 19728 bracket, 94718 plug
19032Y	19350Y light, 19728 bracket, 94718 plug

# 19<sup>®</sup> SERIES, LED, BRACKET MOUNT, HARDWIRED, REFLECTORIZED, KIT

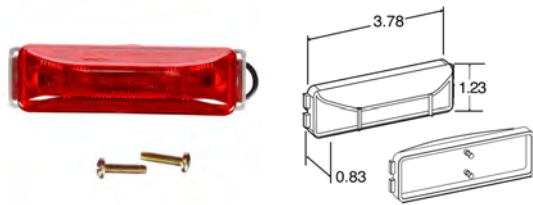

- Innovative optic design allows combination lamp to function as two
- Draws less current, allowing more power for other vehicle requirements
- Designed to fit applications requiring minimal space
- Must be mounted horizontally
- PC-rated lamps meets requirements when mounted on a 45 degree angle
- Standard red lamps have 2-diode pattern
- PC-rated red lamps and standard yellow lamps have 4-diode pattern
- PC-rated yellow lamps have 6-diode pattern

Part Number	Lens Color	Mount Color	Lamp Connector	Plug Side 1	Plug Side 2	Volts	Amps	Diodes	Lighting Codes	Warranty
19006R	Red	Gray	Hardwired	Hardwired	Stripped End	12	0.05	2	P2	3-year
19006Y	Yellow	Gray	Hardwired	Hardwired	Stripped End	12	0.05	4	P2 PC	3-year
19020R	Red	Gray	Hardwired	Hardwired	Stripped End	12	0.1	4	P2 PC	3-year
19020Y	Yellow	Gray	Hardwired	Hardwired	Stripped End	12	0.1	6	P2 PC	3-year

### PARTS INCLUDED IN KITS ABOVE

KIT #	Included Parts
19006R	19250R light, 19721 bracket
19006Y	19250Y light, 19721 bracket

KIT #	Included Parts
19020R	19275R light, 19721 bracket
19020Y	19275Y light, 19721 bracket

# 21<sup>®</sup> SERIES, LED, 2 SCREW

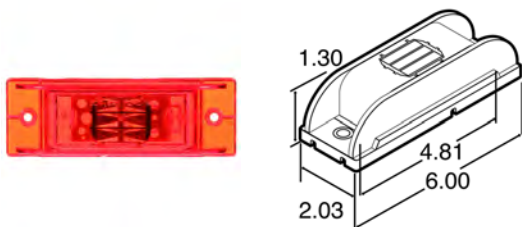

- Innovative optic design allows one PC rated lamp the ability to function as two
- Draws less current, allowing more power for other vehicle requirements
- Uses standard mounting holes and accessories
- Standard lamps have 3-diode pattern
- PC rated lamps have 8-diode pattern

Part Number	Lens Color	Mount Color	Lamp Connector	Volts	Amps	Diodes	Lighting Codes	Warranty
21275R	Red	Red	Fit 'N Forget M/C	12	0.1	8	P2 PC	LIFETIME
21275Y	Yellow	Yellow	Fit 'N Forget M/C	12	0.1	8	P2 PC	LIFETIME

## 21<sup>®</sup> SERIES, LED, 2 SCREW, HARDWIRED

- Popular replacement on Freightliner vehicles where lamp is not mounted on a curved location
- Electronics completely sealed in epoxy to resist corrosion and moisture
- Less susceptible to shock and vibration
- LED lamps offer superior brightness and faster start time than incandescent versions

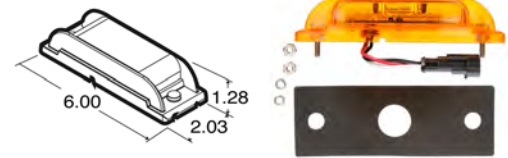

Part Number	Lens Color	Mount Color	Lamp Connector	Plug Side 1	Plug Side 2	Volts	Amps Major/Minor	Diodes	Lighting Codes	Warranty
21093Y	Yellow	Yellow	Hardwired	Hardwired	3 Position Connector	12	0.17/0.03	16	P2 PC	LIFETIME
21090Y	Yellow	Yellow	Hardwired	AMP 282105-1	AMP 282105-1	12	0.17/0.03	16	P2 PC	LIFETIME
21091Y	Yellow	Yellow	Hardwired	AMP 282105-1	AMP 282105-1	12	0.16/0.03	16	P2 PC	LIFETIME
21092Y	Yellow	Yellow	Hardwired	AMP 282105-1	AMP 282105-1	12	0.16/0.03	16	P2 PC	LIFETIME
21094Y	Yellow	Yellow	Hardwired	AMP 282105-1	AMP 282105-1	12	0.16/0.03	16	P2 PC	LIFETIME
21095Y	Yellow	Yellow	Hardwired	AMP 282105-1	AMP 282105-1	12	0.16/0.03	16	P2 PC	LIFETIME
21096Y	Yellow	Yellow	Hardwired	AMP 282105-1	AMP 282105-1	12	0.16/0.03	16	P2 PC	LIFETIME

## 21<sup>®</sup> SERIES, LED, 2 SCREW, KIT



- Innovative optic design allows one PC rated lamp the ability to function as two
- Draws less current, allowing more power for other vehicle requirements
- Uses standard mounting holes and accessories
- Standard lamps have 3-diode pattern
- PC rated lamps have 8-diode pattern

### AVAILABLE CONNECTORS

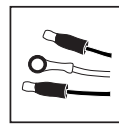

.180 BULLET/  
RING TERMINAL

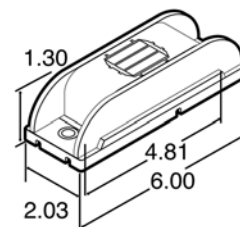

Part Number	Lens Color	Mount Color	Lamp Connector	Plug Side 1	Plug Side 2	Volts	Amps	Diodes	Lighting Codes	Warranty
21075R	Red	Red	Fit 'N Forget M/C	Fit 'N Forget M/C	.180 Bullet/Ring Terminal	12	0.1	8	P2 PC	LIFETIME
21075Y	Yellow	Yellow	Fit 'N Forget M/C	Fit 'N Forget M/C	.180 Bullet/Ring Terminal	12	0.1	8	P2 PC	LIFETIME

### PARTS INCLUDED IN KITS ABOVE

KIT #	Included Parts
21075R	21275R light, 94862 plug
21075Y	21275Y light, 94862 plug

## 21<sup>®</sup> SERIES, LED, 2 SCREW, REFLECTORIZED

LED

21 SERIES

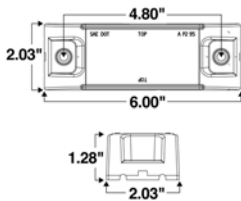

- Innovative optic design allows one PC-rated lamp the ability to function as two
- Draws less current, allowing more power for other vehicle requirements
- Uses standard mounting holes and accessories

Part Number	Lens Color	Mount Color	Lamp Connector	Volts	Amps	Diodes	Lighting Codes	Warranty
21251R	Red	Red	Fit 'N Forget M/C	12	0.1	1	A P2 PC	LIFETIME
21251Y	Yellow	Yellow	Fit 'N Forget M/C	12	0.1	2	A P2 PC	LIFETIME
21256R	Red	Red	Fit 'N Forget M/C	24	0.05	3	A P2 PC	LIFETIME
21256Y	Yellow	Yellow	Fit 'N Forget M/C	24	0.05	3	A P2 PC	LIFETIME
21880R	Red	Red	Fit 'N Forget M/C	12	0.1	1	A P2 PC	LIFETIME
21880Y	Yellow	Yellow	Fit 'N Forget M/C	12	0.1	2	A P2 PC	LIFETIME

## 21<sup>®</sup> SERIES, LED, 2 SCREW, REFLECTORIZED, KIT

LED

21 SERIES

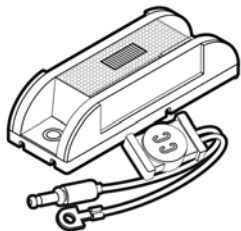

### AVAILABLE CONNECTORS

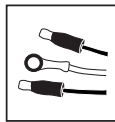

.180 BULLET/  
RING TERMINAL

- Innovative optic design allows one PC-rated lamp the ability to function as two
- Draws less current, allowing more power for other vehicle requirements
- Uses standard mounting holes and accessories



Part Number	Lens Color	Mount Color	Lamp Connector	Plug Side 1	Plug Side 2	Volts	Amps	Diodes	Lighting Codes	Warranty
21051R	Red	Red	Fit 'N Forget M/C	Fit 'N Forget M/C	.180 Bullet/Ring Terminal	12	0.1	1	A P2 PC	LIFETIME
21051Y	Yellow	Yellow	Fit 'N Forget M/C	Fit 'N Forget M/C	.180 Bullet/Ring Terminal	12	0.1	2	A P2 PC	LIFETIME
21056R	Red	Red	Fit 'N Forget M/C	Fit 'N Forget M/C	.180 Bullet/Ring Terminal	24	0.05	3	A P2 PC	LIFETIME
21056Y	Yellow	Yellow	Fit 'N Forget M/C	Fit 'N Forget M/C	.180 Bullet/Ring Terminal	24	0.05	3	A P2 PC	LIFETIME
21080R	Red	Red	Fit 'N Forget M/C	Fit 'N Forget M/C	.180 Bullet/Ring Terminal	12	0.1	1	A P2 PC	LIFETIME
21080Y	Yellow	Yellow	Fit 'N Forget M/C	Fit 'N Forget M/C	.180 Bullet/Ring Terminal	12	0.1	2	A P2 PC	LIFETIME

## 25 SERIES, LED, 2 SCREW, HARDWIRED, KIT

LED

25 SERIES

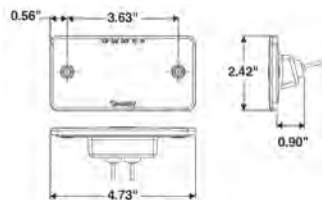

- Hermetically sealed lens and housing
- Electronics completely sealed in epoxy to resist corrosion and moisture
- Less susceptible to shock and vibration
- Draws less current, allowing more power for other vehicle requirements
- Direct pin-to-circuit board solders assure vibration-resistant contacts



Part Number	Lens Color	Mount Color	Lamp Connector	Plug Side 1	Plug Side 2	Volts	Amps	Diodes	Lighting Codes	Warranty
25256Y	Yellow	Yellow	Hardwired	Hardwired	PE Connector	12	0.12	6	P2 PC	1-year

## 25 SERIES, LED, 2 SCREW

- Feature unique lens design for applications requiring a surface mount combination lamp
- Mounting gasket included to improve seal between lamp and vehicle
- Suitable for PC requirements when mounted on a 45-degree angle

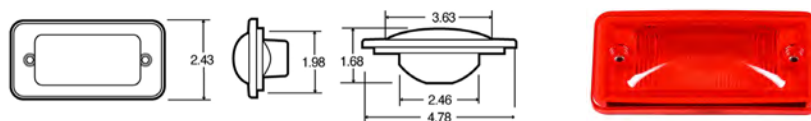

Part Number	Lens Color	Mount Color	Lamp Connector	Volts	Amps	Diodes	Lighting Codes	Warranty
25784R	Red	Red	Socket Assembly	12	0.1	8	P2 PC	1-year
25784Y	Yellow	Yellow	Socket Assembly	12	0.1	8	P2 PC	1-year

## 25 SERIES, LED, 2 SCREW, HARDWIRED

- 25750Y features hardwired connections with optional field installable butt-splice connectors
- Hermetically sealed lens and housing
- Electronics completely sealed in epoxy to resist corrosion and moisture
- Less susceptible to shock and vibration
- Draws less current, allowing more power for other vehicle requirements
- Direct pin-to-circuit board solders assure vibration resistant contacts
- Includes 97701 mounting gasket with #25250R/Y and 25750Y
- 25750Y is legal when mounted 0 to 40 degree rollback from vertical

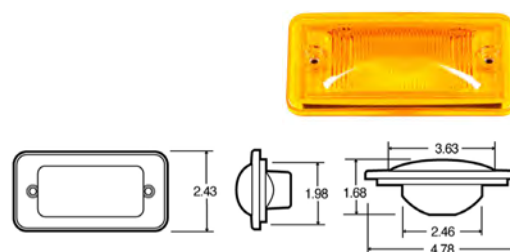

Part Number	Lens Color	Mount Color	Lamp Connector	Plug Side 1	Plug Side 2	Volts	Amps	Diodes	Lighting Codes	Warranty
25250R	Red	Red	Hardwired	Hardwired	Stripped End	12	0.1	3	P2 PC	LIFETIME
25250Y	Yellow	Yellow	Hardwired	Hardwired	Stripped End	12	0.1	3	P2 PC	LIFETIME
25750Y	Yellow	Yellow	Hardwired	Hardwired	Stripped End	12	0.1	3	P2 PC	LIFETIME

## Keep Your Connections Safe. Don't Forget Your Dielectric Gel.

Dielectric gel protects your lights by protecting the points of contact between elements of your lighting and harness system. Our dielectric compounds prevent arcing and corrosion and keep your lights performing as they should.

You can find our dielectric products on page 498



## 26 SERIES, LED, 2 SCREW, HARDWIRED

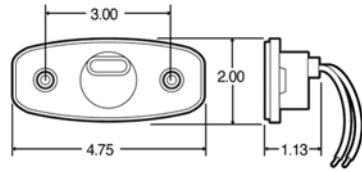

- Popular in trailer and body applications
- Hardwired design with blunt cut or molded bullet ends
- Innovative optics design allows for horizontal or vertical mounting
- Not suitable for PC requirements

Part Number	Lens Color	Mount Color	Lamp Connector	Plug Side 1	Plug Side 2	Volts	Amps	Diodes	Lighting Codes	Warranty
26250R	Red	Red	Hardwired	Hardwired	.180 Bullet	12	0.05	3	P2 PC	LIFETIME
26250Y	Yellow	Yellow	Hardwired	Hardwired	.180 Bullet	12	0.05	3	P2 PC	LIFETIME
26251R	Red	Red	Hardwired	Hardwired	Blunt Cut	12	0.05	3	P2 PC	LIFETIME
26251Y	Yellow	Yellow	Hardwired	Hardwired	Blunt Cut	12	0.05	3	P2 PC	LIFETIME

## 26 SERIES, LED, 2 SCREW, HARDWIRED, KIT

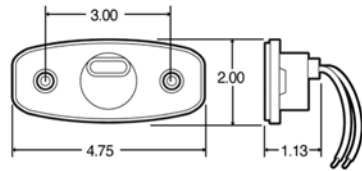

- Unique dome lens design
- Popular in trailer and body applications
- Hard wired design with molded .180 bullet ends
- Innovative optics design allows for horizontal mounting
- LEDs have no filament, therefore are not susceptible to shock and vibration
- Not suitable for PC requirements



Part Number	Lens Color	Mount Color	Lamp Connector	Plug Side 1	Plug Side 2	Volts	Amps	Diodes	Lighting Codes	Warranty
26270R	Red	Red	Hardwired	Hardwired	.180 Bullet	12	0.05	3	P2 PC	LIFETIME
26270Y	Yellow	Yellow	Hardwired	Hardwired	.180 Bullet	12	0.05	3	P2 PC	LIFETIME

## 30<sup>®</sup> SERIES, LED, FLUSH MOUNT

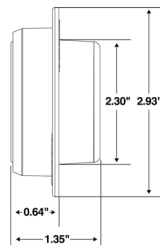

- Low-profile design reduces damage resulting from tree limbs and extruded dock seals

Part Number	Lens Color	Mount Color	Lamp Connector	Volts	Amps	Diodes	Lighting Codes	Warranty
30272R	Red	Gray	Fit 'N Forget M/C	12	0.05	2	P2 P3	LIFETIME
30272Y	Yellow	Gray	Fit 'N Forget M/C	12	0.05	2	P2 P3	LIFETIME

LED

26 SERIES

LED

26 SERIES

LED

30 SERIES



## 30<sup>®</sup> SERIES, LED, FLUSH MOUNT, KIT



- Flange is permanently affixed to lamp
- Lamp kits include one plug or harness
- Direct pin-to-circuit board solders assure vibration-resistant contacts
- Electronics completely sealed in epoxy to resist corrosion and moisture
- Low current draw, leaving more power for other vehicle requirements
- Sonically sealed lens and housing
- LEDs are less susceptible to shock and vibration
- Lamp flush mounts with a grommet or flange
- Approved to comply with ECE regulations for side marker and end outline marker functions
- OmniVolt universal lighting products address increasing vehicle power demands by operating equally in electrical systems that range from 10 to 30 volts

### AVAILABLE CONNECTORS

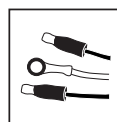

.180 BULLET/  
RING TERMINAL

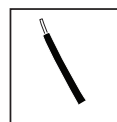

STRIPPED  
END



FEMALE  
PL-10

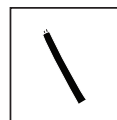

BLUNT  
CUT

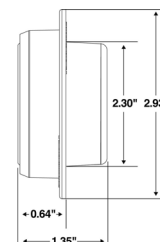

Part Number	Lens Color	Mount Color	Lamp Connector	Plug Side 1	Plug Side 2	Volts	Amps	Diodes	Lighting Codes	Warranty
30051R	Red	Gray	Fit 'N Forget M/C	Fit 'N Forget M/C	Female PL-10	12	0.05	2	P2 P3	LIFETIME
30051Y	Yellow	Gray	Fit 'N Forget M/C	Fit 'N Forget M/C	Female PL-10	12	0.05	2	P2 P3	LIFETIME
30060R	Red	Gray	Fit 'N Forget M/C	Fit 'N Forget M/C	Stripped End	12 24	0.05	3	E1	LIFETIME
30060Y	Yellow	Gray	Fit 'N Forget M/C	Fit 'N Forget M/C	Stripped End	12 24	0.05	3	E1	LIFETIME
30065Y	Yellow	Gray	Fit 'N Forget M/C	Fit 'N Forget M/C	Blunt Cut	12 24	0.05	3	E1	LIFETIME
30066R	Red	Gray	Fit 'N Forget M/C	Fit 'N Forget M/C	Stripped End	12 24	0.05	3	E1	LIFETIME
30066Y	Yellow	Gray	Fit 'N Forget M/C	Fit 'N Forget M/C	Stripped End	12 24	0.05	3	E1	LIFETIME
30071R	Red	Gray	Fit 'N Forget M/C	Fit 'N Forget M/C	Female PL-10	12	0.05	2	P2 P3	LIFETIME
30071Y	Yellow	Gray	Fit 'N Forget M/C	Fit 'N Forget M/C	Female PL-10	12	0.05	2	P2 P3	LIFETIME
30091R	Red	Gray	Fit 'N Forget M/C	Fit 'N Forget M/C	Female PL-10	12	0.12	6	P2 PC	LIFETIME
30091Y	Yellow	Gray	Fit 'N Forget M/C	Fit 'N Forget M/C	Female PL-10	12	0.12	6	P2 PC	LIFETIME

### PARTS INCLUDED IN KITS ABOVE

KIT #	Included Parts
30051R	30251R light, 93745 plug
30051Y	30251Y light, 93745 plug
30060R	30251Y light, 93745 plug
30060Y	30265R light, 94781 plug
30065Y	30265Y light, 93745 plug
30066R	30265Y light, 94782 plug
30066Y	30265Y light, 94782 plug
30071R	302272R light, 93745 plug
30071Y	30272Y light, 93745 plug
30091R	30386R light, 93745 plug
30091Y	30386Y light, 93745 plug

## 30<sup>®</sup> SERIES, LED, FLANGE MOUNT

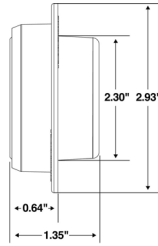

- Flange is permanently affixed to lamp
- Lamp kits include one plug or harness
- Direct pin-to-circuit board solders assure vibration-resistant contacts
- Electronics completely sealed in epoxy to resist corrosion and moisture
- Low current draw, leaving more power for other vehicle requirements
- Sonically sealed lens and housing
- LEDs are less susceptible to shock and vibration
- Lamp flush mounts with a grommet or flange
- Approved to comply with ECE regulations for side marker and end outline marker functions
- OmniVolt universal lighting products address increasing vehicle power demands by operating equally in electrical systems that range from 10 to 30 volts

Part Number	Lens Color	Mount Color	Lamp Connector	Volts	Amps	Diodes	Lighting Codes	Warranty
30251R	Red	Gray	Fit 'N Forget M/C	12	0.05	2	P2 P3	LIFETIME
30251Y	Yellow	Gray	Fit 'N Forget M/C	12	0.05	2	P2 P3	LIFETIME
30262R	Red	Gray	Fit 'N Forget M/C	12 24	0.05	1	E1	LIFETIME
30262Y	Yellow	Gray	Fit 'N Forget M/C	12 24	0.05	1	E1	LIFETIME
30265R	Red	Gray	Fit 'N Forget M/C	12 24	0.05	1	E1	LIFETIME
30265Y	Yellow	Gray	Fit 'N Forget M/C	12 24	0.05	1	E1	LIFETIME
30269Y	Yellow	Gray	PL-10	12	0.1	8	P2 P3 PC	3-year
30271Y	Yellow	Gray	Fit 'N Forget M/C	12	0.05	2	P2 P3	LIFETIME
30279R	Red	Gray	PL-10	12	0.1	8	P2 P3 PC	3-year
30279Y	Yellow	Gray	PL-10	12	0.1	8	P2 P3 PC	3-year
30288R	Red	Black	PL-10	12	0.12	6	P2 PC	3-year
30288Y	Yellow	Black	PL-10	12	0.12	6	P2 PC	3-year
30289R	Red	Gray	PL-10	12	0.12	6	P2 PC	3-year
30289Y	Yellow	Gray	PL-10	12	0.12	6	P2 PC	3-year
30379R	Red	Gray	Fit 'N Forget M/C	12	0.1	8	P2 P3 PC	LIFETIME
30379Y	Yellow	Gray	Fit 'N Forget M/C	12	0.1	8	P2 P3 PC	LIFETIME
30386R	Red	Gray	Fit 'N Forget M/C	12	0.12	6	P2 PC	LIFETIME
30386Y	Yellow	Gray	Fit 'N Forget M/C	12	0.1	6	P2 PC	LIFETIME

## 30<sup>®</sup> SERIES, LED, FLANGE MOUNT, KIT



- Flange is permanently affixed to lamp
- Lamp kits include one plug or harness
- Direct pin-to-circuit board solders assure vibration-resistant contacts
- Electronics completely sealed in epoxy to resist corrosion and moisture
- Low current draw, leaving more power for other vehicle requirements
- Sonically sealed lens and housing
- LEDs are less susceptible to shock and vibration
- Lamp flush mounts with a grommet or flange
- Approved to comply with ECE regulations for side marker and end outline marker functions
- OmniVolt universal lighting products address increasing vehicle power demands by operating equally in electrical systems that range from 10 to 30 volts

### AVAILABLE CONNECTORS

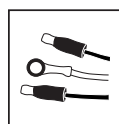

.180 BULLET/  
RING TERMINAL

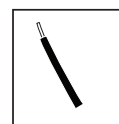

STRIPPED  
END



FEMALE  
PL-10

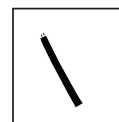

BLUNT  
CUT

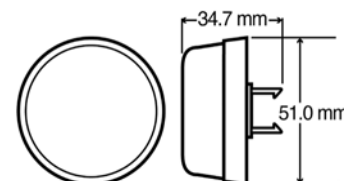

Part Number	Lens Color	Mount Color	Lamp Connector	Plug Side 1	Plug Side 2	Volts	Amps	Diodes	Lighting Codes	Warranty
30061R	Red	Gray	Fit 'N Forget M/C	Fit 'N Forget M/C	Stripped End	12 24	0.05	3	E1	LIFETIME
30061Y	Yellow	Gray	Fit 'N Forget M/C	Fit 'N Forget M/C	Stripped End	12 24	0.05	3	E1	LIFETIME
30062R	Red	Gray	Fit 'N Forget M/C	Fit 'N Forget M/C	Blunt Cut	12 24	0.05	3	E1	LIFETIME
30080R	Red	Gray	PL-10	PL-10	.180 Bullet/ Ring Terminal	12	0.1	8	P2 P3 PC	LIFETIME
30080Y	Yellow	Gray	PL-10	PL-10	.180 Bullet/ Ring Terminal	12	0.1	8	P2 P3 PC	LIFETIME
30090R	Red	Gray	Fit 'N Forget M/C	Fit 'N Forget M/C	Female PL-10	12	0.1	8	P2 P3 PC	3-year
30090Y	Yellow	Gray	Fit 'N Forget M/C	Fit 'N Forget M/C	Female PL-10	12	0.1	8	P2 P3 PC	3-year

### PARTS INCLUDED IN KITS ABOVE

KIT #	Included Parts
30061R	30262R light, 94782 plug
30061Y	30262Y light, 94782 plug
30062R	30262R light, 94609 plug
30080R	30279R light, 94964 plug
30080Y	30279Y light, 94964 plug
30090R	30379R light, 93745 plug
30090Y	30379Y light, 93745 plug

### 30<sup>®</sup> SERIES, LED, GROMMET MOUNT, BEEHIVE

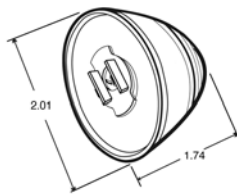

- Popular replacement for cab marker or corner trailer applications
- LEDs have no filament, therefore are not susceptible to shock and vibration
- Meets SAE 592e standards
- Less current draw, resulting in increased battery and alternator life while allowing more power for other vehicle requirements
- Red lamp has 2 diode pattern and Yellow lamp has 5 diode pattern

Part Number	Lens Color	Lamp Connector	Volts	Amps	Diodes	Lighting Codes	Warranty
30276R	Red	Fit 'N Forget M/C	12	0.05	2	P2 PC	LIFETIME
30276Y	Yellow	Fit 'N Forget M/C	12	0.05	5	P2 PC	LIFETIME

### 30<sup>®</sup> SERIES, LED, GROMMET MOUNT

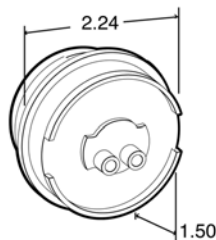

- Flange is permanently affixed to lamp
- Lamp kits include one plug or harness
- Direct pin-to-circuit board solders assure vibration resistant contacts
- Electronics completely sealed in epoxy to resist corrosion and moisture
- Low current draw, leaving more power for other vehicle requirements
- Sonically sealed lens and housing
- LEDs are less susceptible to shock and vibration
- Lamp flush mounts with a grommet or flange
- Approved to comply with ECE regulations for side marker and end outline marker functions
- Omnivolt universal lighting products address increasing vehicle power demands by operating equally in electrical systems that range from 10 to 30 volts

Part Number	Lens Color	Lamp Connector	Volts	Amps	Diodes	Lighting Codes	Warranty
30250R	Red	Fit 'N Forget M/C	12	0.05	2	P2 P3	LIFETIME
30250Y	Yellow	Fit 'N Forget M/C	12	0.05	2	P2 P3	LIFETIME
30255R	Red	Fit 'N Forget M/C	12 24	0.05	3	P2 P3	LIFETIME
30255Y	Yellow	Fit 'N Forget M/C	12 24	0.05	3	P2 P3	LIFETIME
30264Y	Yellow	PL-10	12	0.1	8	P2 PC	3-year
30270R	Red	Fit 'N Forget M/C	12	0.05	2	P2 P3	LIFETIME
30270Y	Yellow	Fit 'N Forget M/C	12	0.05	2	P2 P3	LIFETIME
30273R	Red	Fit 'N Forget M/C	12 24	0.05	3	E1	LIFETIME
30273Y	Yellow	Fit 'N Forget M/C	12 24	0.05	3	E1	LIFETIME
30275R	Red	PL-10	12	0.1	8	P2 P3 PC	3-year
30275Y	Yellow	PL-10	12	0.1	8	P2 P3 PC	3-year
30285R	Red	PL-10	12	0.12	6	P2 PC	3-year
30285Y	Yellow	PL-10	12	0.12	6	P2 PC	3-year
30375R	Red	Fit 'N Forget M/C	12	0.1	8	P2 P3 PC	LIFETIME
30375Y	Yellow	Fit 'N Forget M/C	12	0.1	8	P2 P3 PC	LIFETIME
30385R	Red	Fit 'N Forget M/C	12	0.12	6	P2 PC	LIFETIME
30385Y	Yellow	Fit 'N Forget M/C	12	0.1	6	P2 PC	LIFETIME

## 30<sup>®</sup> SERIES, LED, GROMMET MOUNT, KIT



- Flange is permanently affixed to lamp
- Lamp kits include one plug or harness
- Direct pin-to-circuit board solders assure vibration-resistant contacts
- Electronics completely sealed in epoxy to resist corrosion and moisture
- Low current draw, leaving more power for other vehicle requirements
- Sonically sealed lens and housing
- LEDs are less susceptible to shock and vibration
- Lamp flush mounts with a grommet or flange
- Approved to comply with ECE regulations for side marker and end outline marker functions
- Omnivolt universal lighting products address increasing vehicle power demands by operating equally in electrical systems that range from 10 to 30 volts

### AVAILABLE CONNECTORS

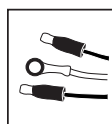

.180 BULLET/  
RING TERMINAL



FEMALE  
PL-10

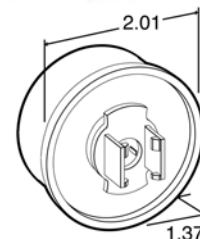

Part Number	Lens Color	Mount Color	Lamp Connector	Plug Side 1	Plug Side 2	Volts	Amps	Diodes	Lighting Codes	Warranty
30050R	Red	Black	Fit 'N Forget M/C	Fit 'N Forget M/C	Female PL-10	12	0.05	2	P2 P3	LIFETIME
30050Y	Yellow	Black	Fit 'N Forget M/C	Fit 'N Forget M/C	Female PL-10	12	0.05	2	P2 P3	LIFETIME
30055R	Red	Black	Fit 'N Forget M/C	Fit 'N Forget M/C	Female PL-10	12 24	0.05	3	P2 P3	LIFETIME
30055Y	Yellow	Black	Fit 'N Forget M/C	Fit 'N Forget M/C	Female PL-10	12 24	0.05	3	P2 P3	LIFETIME
30070R	Red	Black	Fit 'N Forget M/C	Fit 'N Forget M/C	Female PL-10	12	0.05	2	P2 P3	LIFETIME
30070Y	Yellow	Black	Fit 'N Forget M/C	Fit 'N Forget M/C	Female PL-10	12	0.05	2	P2 P3	LIFETIME
30075R	Red	Black	PL-10	PL-10	.180 Bullet/ Ring Terminal	12	0.1	8	P2 P3 PC	LIFETIME
30075Y	Yellow	Black	PL-10	PL-10	.180 Bullet/ Ring Terminal	12	0.1	8	P2 P3 PC	3-year
30085R	Red	Black	Fit 'N Forget M/C	Fit 'N Forget M/C	Female PL-10	12	0.1	8	P2 P3 PC	3-year
30085Y	Yellow	Black	Fit 'N Forget M/C	Fit 'N Forget M/C	Female PL-10	12	0.1	8	P2 P3 PC	LIFETIME
30086R	Red	Black	Fit 'N Forget M/C	Fit 'N Forget M/C	Female PL-10	12	0.12	6	P2 PC	LIFETIME
30086Y	Yellow	Black	Fit 'N Forget M/C	Fit 'N Forget M/C	Female PL-10	12	0.12	6	P2 PC	LIFETIME

### PARTS INCLUDED IN KITS ABOVE

KIT #	Included Parts
30050R	30250R light, 30700 grommet, 93745 plug
30050Y	30250Y light, 30700 grommet, 93745 plug
30055R	30255R light, 30700 grommet, 93745 plug
30055Y	30255Y light, 30700 grommet, 93745 plug
30070R	30270R light, 30700 grommet, 93745 plug
30070Y	30270Y light, 30700 grommet, 93745 plug
30075R	30275R light, 306700 grommet, 94964 plug
30075Y	30275Y light, 306700 grommet, 94964 plug
30085R	30375R light, 30700 grommet, 93745 plug
30085Y	30375Y light, 30700 grommet, 93745 plug
30086R	30385R light, 30700 grommet, 93745 plug
30086Y	30385Y light, 30700 grommet, 93745 plug

### 30<sup>®</sup> SERIES, LED, BRACKET MOUNT, KIT

LED

30 SERIES

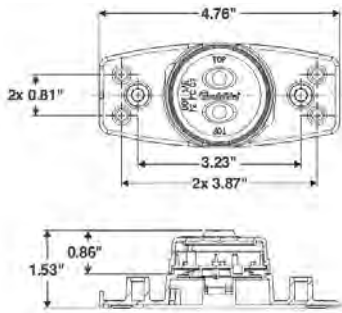

- Complies with FMVSS 108 requirements
- Brackets utilize standard military color scheme
- Kits include a deflector mount with an inner bracket that allows cam-on of the lamp for quick installation
- Manufactured out of ABS material
- OmniVolt Technology (12 or 24 volt systems will run without adjustment)
- LED life surpasses the 2000 hours of incandescent bulbs by nearly 50x
- Lens and housing assemblies constructed of impact-resistant polycarbonate
- All electronics fully sealed in epoxy, making lamps less susceptible to shock and vibration
- Faster start-up times and low current draw

Part Number	Lens Color	Mount Color	Lamp Connector	Plug Side 1	Plug Side 2	Volts	Amps Major/Minor	Diodes	Lighting Codes	Warranty
07394	Yellow	Tan	Fit 'N Forget M/C	Fit 'N Forget M/C	Female Military Boot/Ring Terminal	12 24	0.14/0.06	6	P2 PC	1-year
07395	Red	Black	Fit 'N Forget M/C	Fit 'N Forget M/C	Female Military Boot/Ring Terminal	12 24	0.14/0.06	6	P2 PC	1-year
07396	Yellow	Black	Fit 'N Forget M/C	Fit 'N Forget M/C	Female Military Boot/Ring Terminal	12 24	0.14/0.06	6	P2 PC	1-year
07393	Red	Tan	Fit 'N Forget M/C	Fit 'N Forget M/C	Female Military Boot/Ring Terminal	12 24	0.1	6	P2 PC	1-year

### 33<sup>®</sup> SERIES, LED, FLANGE MOUNT

LED

33 SERIES

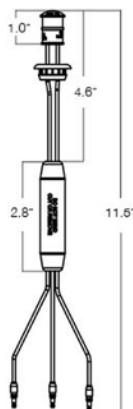

- World smallest LED marker lamp for the transportation industry
- Provides increased visibility when braking or turning
- Functions as a marker, auxiliary turn and auxiliary stop when properly installed
- Best-in-class auxiliary brake function is seven times brighter than marker function
- Marker function exceeds P2 legal requirements
- Requires a 0.75 mounting hole
- Hardwired lamp with .180 male bullet design can be easily retrofitted
- LEDs draw less current, allowing more power for other vehicle requirements
- LEDs do not have a filament, therefore are not susceptible to damage from shock and vibration
- Engineered to withstand the toughest working environments
- Electronics sealed in epoxy to resist corrosion and moisture
- Backed by our industry-leading limited Lifetime Warranty
- Complies with FMVSS-108 marker/clearance requirements

Part Number	Lens Color	Mount Color	Lamp Connector	Plug Side 1	Plug Side 2	Volts	Amps Major/Minor	Diodes	Lighting Codes	Warranty
33207R	Red	Black	Hardwired	.180 Bullet	PC	12	0.17/0.02	1	P2 PC	LIFETIME
33208R	Red	Chrome	Hardwired	.180 Bullet	PC	12	0.17/0.02	1	P2 PC	LIFETIME

## 33<sup>®</sup> SERIES, LED, FLANGE MOUNT, KIT



- World smallest LED marker lamp for the transportation industry
- Provides increased visibility when braking or turning
- Functions as a marker, auxiliary turn and auxiliary stop when properly installed
- Best-in-class auxiliary brake function is seven times brighter than marker function
- Marker function exceeds P2 legal requirements
- Requires a 0.75 mounting hole
- Hardwired lamp with .180 male bullet design can be easily retrofitted
- LEDs draw less current, allowing more power for other vehicle requirements
- LEDs do not have a filament, therefore are not susceptible to damage from shock and vibration
- Engineered to withstand the toughest working environments
- Electronics sealed in epoxy to resist corrosion and moisture & Backed by our industry-leading limited Lifetime Warranty
- Complies with FMVSS-108 marker/clearance requirements

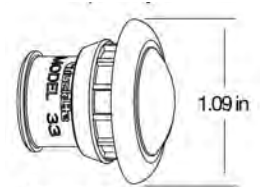

Grommet Mount

Part Number	Lens Color	Mount Color	Lamp Connector	Plug Side 1	Plug Side 2	Volts	Amps Major/Minor	Diodes	Lighting Codes	Warranty
33080R	Red	Black	Hardwired	Hardwired	.180 Bullet	12	0.14	1	P2 PC	LIFETIME
33051R	Red	Black	Hardwired	Hardwired	.180 Bullet	12	0.05	1	P2 PC	LIFETIME
33051Y	Yellow	Black	Hardwired	Hardwired	.180 Bullet	12	0.05	1	P2	LIFETIME
33080Y	Yellow	Black	Hardwired	Hardwired	.180 Bullet	12	0.14	1	PC	LIFETIME
33207Y	Yellow	Black	Hardwired	Hardwired	.180 Bullet	12	0.12/0.03	1	P2	LIFETIME
33208Y	Yellow	Chrome	Hardwired	Hardwired	.180 Bullet	12	0.12/0.03	1	P2 PC	LIFETIME

### PARTS INCLUDED IN KITS ABOVE

KIT #	Included Parts
33080R	33275R light, 33800 grommet
33051R	33250R light, 33800 grommet
33051Y	33250Y light, 33800 grommet
33080Y	33275Y light, 33800 grommet
33207Y	33275Y light, 33800 grommet

## Keep Your Connections Safe. Don't Forget Your Dielectric Gel.

Dielectric gel protects your lights by protecting the points of contact between elements of your lighting and harness system. Our dielectric compounds prevent arcing and corrosion and keep your lights performing as they should.

You can find our dielectric products on page 498



### 33<sup>®</sup> SERIES, LED, GROMMET MOUNT



- World's smallest LED marker lamp for the transportation industry
- Exceeds legal requirements
- Hardwired lamp design is easily retrofitted
- LEDs draw less current, allowing more power for other vehicle requirements
- Electronics completely sealed in epoxy to resist corrosion and moisture
- Offers trailer engineers and manufacturers new trailer and rear door structure design flexibility
- Requires 3/4" mounting hole
- Reduces lighting costs due to physical damage and heat entrapment

Part Number	Lens Color	Mount Color	Lamp Connector	Plug Side 1	Plug Side 2	Volts	Amps	Diodes	Lighting Codes	Warranty
33275R	Red	Black	Hardwired	Hardwired	.180 Bullet	12	0.14	1	P2 PC	LIFETIME
33285Y	Yellow	Chrome	Hardwired	Hardwired	.180 Bullet	12	0.14	1	P2 PC	LIFETIME
33285R	Red	Chrome	Hardwired	Hardwired	.180 Bullet	12	0.14	1	P2 PC	LIFETIME
33256Y	Yellow	Chrome	Hardwired	Hardwired	Ring Terminal	12	0.03	1	P2 PC	LIFETIME
33250R	Red	Chrome	Hardwired	Hardwired	.180 Bullet	12	0.05	1	P2 PC	LIFETIME
33250Y	Yellow	Chrome	Hardwired	Hardwired	.180 Bullet	12	0.05	1	P2 PC	LIFETIME
33275Y	Red	Chrome	Hardwired	Hardwired	.180 Bullet	12	0.14	1	P2 PC	LIFETIME

### 33<sup>®</sup> SERIES, LED, GROMMET MOUNT, KIT



**AVAILABLE CONNECTORS**



.180 BULLET

- World's smallest LED marker lamp for the transportation industry
- Provides increased visibility when braking or turning
- Functions as a marker, auxiliary turn and auxiliary stop when properly installed
- Best-in-class auxiliary brake function is seven times brighter than marker function
- Requires a 3/4" mounting hole
- Hardwired lamp with .180 male bullet design can be easily retrofitted



Part Number	Lens Color	Mount Color	Lamp Connector	Plug Side 1	Plug Side 2	Volts	Amps Major/Minor	Diodes	Lighting Codes	Warranty
33075R	Red	Black	Hardwired	Hardwired	.180 Bullet	12	0.14	1	PC	LIFETIME
33203R	Red	Black	Hardwired	Hardwired	.180 Bullet	12	0.17/0.02	1	P2 PC	LIFETIME
33204R	Red	Black	Hardwired	Hardwired	.180 Bullet	12	0.17/0.02	1	P2 PC	LIFETIME
33205R	Red	Black	Hardwired	Hardwired	.180 Bullet	12	0.17/0.02	1	P2 PC	LIFETIME
33206R	Red	Black	Hardwired	Hardwired	.180 Bullet	12	0.17/0.02	1	P2 PC	LIFETIME
33070R	Red	Black	Hardwired	Hardwired	.180 Bullet	12	0.06	1	P2	LIFETIME
33071R	Red	Black	Hardwired	Hardwired	.180 Bullet	12	0.06	1	P2 P3 PC	LIFETIME
33072R	Red	Black	Hardwired	Hardwired	.180 Bullet	12	0.06	1	P2 P3 PC	LIFETIME
33050R	Red	Black	Hardwired	Hardwired	.180 Bullet	12	0.05	1	P2	LIFETIME
33050Y	Yellow	Black	Hardwired	Hardwired	.180 Bullet	12	0.05	1	P2	LIFETIME
33075Y	Yellow	Black	Hardwired	Hardwired	.180 Bullet	12	0.14	1	PC	LIFETIME
33203Y	Yellow	Black	Hardwired	Hardwired	.180 Bullet	12	0.12/0.02	1	P2 PC	LIFETIME
33206Y	Yellow	Black	Hardwired	Hardwired	.180 Bullet	12	0.12/0.03	1	P2 PC	LIFETIME
33209Y	Yellow	Black	Hardwired	Hardwired	.180 Bullet	12	0.12/0.03	1	P2 PC	LIFETIME
33204Y	Yellow	Black	Hardwired	Hardwired	.180 Bullet	12	0.12/0.03	1	P2 PC	LIFETIME
33205Y	Yellow	Black	Hardwired	Hardwired	.180 Bullet	12	0.12/0.03	1	P2 PC	LIFETIME

**PARTS INCLUDED IN KITS ABOVE**

KIT #	Included Parts
33075R	33275R light, 33700 grommet
33070R	33700 grommet

KIT #	Included Parts
33071R	33720 grommet
33072R	33725 grommet

KIT #	Included Parts
33050R	33250R light, 33700 grommet
33050Y	33250Y light, 33700 grommet
33075Y	33275Y light, 33700 grommet



## 35<sup>®</sup> SERIES, LED, 2 SCREW

- US patent 7,658,524
- Exceeds legal requirements
- Hardwired lamp design is easily retrofitted
- Requires 3/4" mounting hole

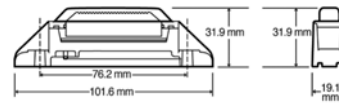

Part Number	Lens Color	Mount Color	Lamp Connector	Volts	Amps	Diodes	Lighting Codes	Warranty
35200R	Red	Red	Fit 'N Forget M/C	12	0.05	1	P2 PC	LIFETIME
35200Y	Yellow	Yellow	Fit 'N Forget M/C	12	0.05	2	P2 PC	LIFETIME
35201R	Clear Red	Clear	Fit 'N Forget M/C	12	0.05	1	P2 PC	LIFETIME
35201Y	Clear Yellow	Clear	Fit 'N Forget M/C	12	0.05	2	P2 PC	LIFETIME
35207Y	Yellow	Yellow	Fit 'N Forget M/C	12	0.08	7	E1	LIFETIME
35209Y	Yellow	Yellow	Fit 'N Forget M/C	24	0.04	7	E1	LIFETIME
35375R	Red	Red	Fit 'N Forget M/C	12	0.12	5	P2 PC	LIFETIME
35375Y	Yellow	Yellow	Fit 'N Forget M/C	12	0.12	5	P2 PC	LIFETIME
35880R	Red	Red	Fit 'N Forget M/C	12	0.05	1	P2 PC	LIFETIME
35880Y	Yellow	Yellow	Fit 'N Forget M/C	12	0.05	2	P2 PC	LIFETIME
35890R	Red	Red	Fit 'N Forget M/C	12 24	0.05	2	P2 P3	LIFETIME
35890Y	Yellow	Yellow	Fit 'N Forget M/C	12 24	0.05	2	P2 P3	LIFETIME

## 35<sup>®</sup> SERIES, LED, 2 SCREW, KIT

- OmniVolt Technology (12 or 24 volt systems will run without adjustment)
- Form/Fit/Function replacements for current product
- Lens and housing assemblies constructed of impact-resistant polycarbonate
- All electronics fully sealed in epoxy, making lamps less susceptible to shock and vibration
- Faster start-up times and low current draw

### AVAILABLE CONNECTORS

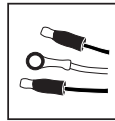

.180 BULLET/  
RING TERMINAL

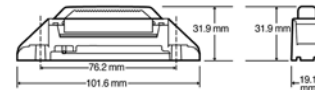

Part Number	Lens Color	Mount Color	Lamp Connector	Plug Side 1	Plug Side 2	Volts	Amps	Diodes	Lighting Codes	Warranty
35001R	Red	Red	Fit 'N Forget M/C	Fit 'N Forget M/C	.180 Bullet/Ring Terminal	12	0.05	1	P2 PC	LIFETIME
35001Y	Yellow	Yellow	Fit 'N Forget M/C	Fit 'N Forget M/C	.180 Bullet/Ring Terminal	12	0.05	1	P2 PC	LIFETIME
35004R	Red	Red	Fit 'N Forget M/C	Fit 'N Forget M/C	.180 Bullet/Ring Terminal	12 24	0.05	2	P2 P3	LIFETIME
35004Y	Yellow	Yellow	Fit 'N Forget M/C	Fit 'N Forget M/C	.180 Bullet/Ring Terminal	12 24	0.05	2	P2 P3	LIFETIME
35007Y	Yellow	Yellow	Fit 'N Forget M/C	Fit 'N Forget M/C	.180 Bullet/Ring Terminal	12	0.08	7	E1	LIFETIME
35009Y	Yellow	Yellow	Fit 'N Forget M/C	Fit 'N Forget M/C	.180 Bullet/Ring Terminal	24	0.04	7	E1	LIFETIME
35075R	Red	Red	Fit 'N Forget M/C	Fit 'N Forget M/C	.180 Bullet/Ring Terminal	12	0.12	5	P2 PC	LIFETIME
35075Y	Yellow	Yellow	Fit 'N Forget M/C	Fit 'N Forget M/C	.180 Bullet/Ring Terminal	12	0.12	5	P2 PC	LIFETIME
35080R	Red	Red	Fit 'N Forget M/C	Fit 'N Forget M/C	.180 Bullet/Ring Terminal	12	0.05	1	P2 PC	LIFETIME
35080Y	Yellow	Yellow	Fit 'N Forget M/C	Fit 'N Forget M/C	.180 Bullet/Ring Terminal	12	0.05	2	P2 PC	LIFETIME

### PARTS INCLUDED IN KITS ABOVE

KIT #	Included Parts	KIT #	Included Parts	KIT #	Included Parts	KIT #	Included Parts
35001R	35200R light, 94862	35004Y	35890Y light, 94862	35075R	35375R light, 94892 plug	35080Y	35880Y light, 94862 plug
35001Y	35200Y light, 94862	35007Y	35207Y light, 94862 plug	35075Y	35375Y light, 94892 plug		
35004R	35890R light, 94862	35009Y	35209Y light	35080R	35880R light, 94862 plug		

### 36 SERIES, LED, ADHESIVE MOUNT

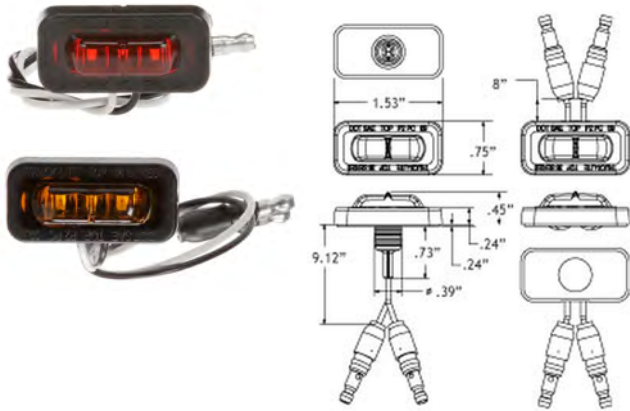

- Lamps operate in minor and major output levels: major function activated by the brake function or turn signal
- Yellow major function is three times brighter than minor function
- Red major function is seven times brighter than minor function
- Provides marker/clearance solution that requires no mounting brackets or installation screws
- Lamps adhere directly to application surface through use of heavy-duty adhesive backing
- P2-Rated
- Electronics are completely sealed in epoxy to resist damage caused by moisture and corrosion
- Easy-to-install, peel-off liner
- Rear exit wire version requires a 3/8" mounting hole, and self-seals hole upon installation
- Care should be taken for proper installation

Part Number	Lens Color	Mount Color	Lamp Connector	Plug Side 1	Plug Side 2	Volts	Amps Major/Minor	Diodes	Lighting Codes	Warranty
36203R	Red	Black	Hardwired	Hardwired	.180 Bullet	12	0.06/0.01	3	P2	LIFETIME
36203Y	Yellow	Black	Hardwired	Hardwired	.180 Bullet	12	0.06/0.02	3	P2	LIFETIME
36105R	Red	Black	Hardwired	Hardwired	.180 Bullet	12	0.03	3	P2 PC	LIFETIME
36105Y	Yellow	Black	Hardwired	Hardwired	.180 Bullet	12	0.05	3	P2 PC	LIFETIME
36115R	Red	Black	Hardwired	Hardwired	.180 Bullet	12	0.03	3	P2 PC	LIFETIME
36115Y	Yellow	Black	Hardwired	Hardwired	.180 Bullet	12	0.05	3	P2 PC	LIFETIME

### 36 SERIES, LED, ADHESIVE MOUNT/2 SCREW, WINGED



- Winged housing provides option for mounting around corners on a radius
- Provides a clearance/marker solution that requires no mounting brackets or installation screws
- Lamps adhere directly to application surface through the use of heavy-duty adhesive backing
- Easy-to-install, peel-off liner
- Hardwired lamp design is easily retrofitted
- Rear exit wire version requires a 3/8" mounting hole, and self-seals hole upon installation
- Side mount options can be mounted without any mounting holes
- LEDs draw much less current, allowing more power for other vehicle requirements
- Electronics are completely sealed in epoxy to resist damage caused by moisture and corrosion
- Reduces lighting costs caused by physical damage and heat entrapment

Part Number	Lens Color	Mount Color	Lamp Connector	Plug Side 1	Plug Side 2	Volts	Amps Major/Minor	Diodes	Lighting Codes	Warranty
36100R	Red	Black	Hardwired	Hardwired	.180 Bullet	12	0.03	3	P2 PC	LIFETIME
36100Y	Yellow	Black	Hardwired	Hardwired	.180 Bullet	12	0.05	3	P2 PC	LIFETIME
36110R	Red	Black	Hardwired	Hardwired	.180 Bullet	12	0.03	3	P2 PC	LIFETIME
36110Y	Yellow	Black	Hardwired	Hardwired	.180 Bullet	12	0.05	3	P2 PC	LIFETIME
36213R	Red	Black	Hardwired	Hardwired	.180 Bullet	12	0.06/0.01	3	P2 PC	LIFETIME
36130R	Red	Black	Hardwired	Hardwired	.180 Bullet/ Female .180 Bullet	12 24	0.05	3	P2 PC	LIFETIME
36130Y	Yellow	Black	Hardwired	Hardwired	.180 Bullet/ Female .180 Bullet	12 24	0.05	3	P2 PC	LIFETIME

## 10<sup>®</sup> SERIES, INCANDESCENT, GROMMET MOUNT

- Lens and housing are sonically sealed
- High-impact polycarbonate construction
- 15,000-hour-rated bulb life
- Available in either 12 volt or 24 volt
- Meets PC requirement on a 45-degree angle in mounting devices #10708, #10720, #00803 or #00804
- Replaces Signal-Stat 1010 and 1011 series



Part Number	Lens Color	Lamp Connector	Volts	Amps	Bulbs	Lighting Codes	Warranty
10202B	Blue	PL-10	12	0.33	1	P2 PC	1-year
10202G	Green	PL-10	12	0.33	1	P2 PC	1-year
10202R	Red	PL-10	12	0.33	1	P2 PC	1-year
10202Y	Yellow	PL-10	12	0.33	1	P2 PC	1-year
10204R	Red	PL-10	24	0.17	1	P2 PC	1-year
10204Y	Yellow	PL-10	24	0.17	1	P2 PC	1-year

## 10<sup>®</sup> SERIES, INCANDESCENT, GROMMET MOUNT, REFLECTORIZED

- Lens and housing are sonically sealed
- High-impact polycarbonate construction
- 15,000-hour-rated bulb life
- Available in either 12 volt or 24 volt
- Meets PC requirement on a 45-degree angle in mounting devices #10708, #10720, #00803 or #00804
- Replaces Signal-Stat 1010 and 1011 series



Part Number	Lens Color	Mount Color	Lamp Connector	Plug Side 1	Plug Side 2	Volts	Amps	Bulbs	Lighting Codes	Warranty
10205R	Red		PL-10			12	0.33	1	A P2 PC	1-year
10205Y	Yellow		PL-10			12	0.33	1	A P2 PC	1-year

## 10<sup>®</sup> SERIES, INCANDESCENT, GROMMET MOUNT, REFLECTORIZED, KIT



- Lens and housing are sonically sealed
- High-impact polycarbonate construction
- 15,000-hour-rated bulb life
- Available in either 12 or 24 volt
- Meets PC requirement on a 45-degree angle in mounting devices #10708, #10720, #00803 or #00804
- Replaces Signal-Stat 1010 and 1011 series

### AVAILABLE CONNECTORS

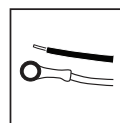

RING TERMINAL / STRIPPED END



Part Number	Lens Color	Mount Color	Lamp Connector	Plug Side 1	Plug Side 2	Volts	Amps	Bulbs	Lighting Codes	Warranty
10525R	Red	Black	PL-10	PL-10	Ring Terminal/ Stripped End	12	0.33	1	A P2 PC	1-year
10525Y	Yellow	Black	PL-10	PL-10	Ring Terminal/ Stripped End	12	0.33	1	A P2 PC	1-year

### PARTS INCLUDED IN KITS ABOVE

KIT #	Included Parts
10525R	10205R light, 10700 grommet, 94902 plug
10525Y	10205Y light, 10700 grommet, 94902 plug

# 10<sup>®</sup> SERIES, INCANDESCENT, BRACKET MOUNT, KIT



**AVAILABLE CONNECTORS**

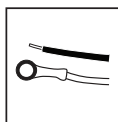

RING TERMINAL / STRIPPED END

- Rust-resistant stainless steel mount
- Quick cam-on, cam-off lamp installation
- Suitable for PC requirements on a 45-degree angle using all 2-1/2" diameter lamps
- Mounts with screws to surface
- Model 10 kits available
- Not recommended for use with Signal-Stat LED products
- Replaces Signal-Stat 9394



Part Number	Lens Color	Mount Color	Lamp Connector	Plug Side 1	Plug Side 2	Volts	Amps	Bulbs	Lighting Codes	Warranty
10520R	Red	Gray	PL-10	PL-10	Ring Terminal Stripped End	12	0.33	1	P2 PC	1-year
10520Y	Yellow	Gray	PL-10	PL-10	Ring Terminal Stripped End	12	0.33	1	P2 PC	1-year
10004R	Red	Silver	PL-10	PL-10	Ring Terminal Stripped End	12	0.33	1	A P2 PC	1-year
10004Y	Yellow	Silver	PL-10	PL-10	Ring Terminal Stripped End	12	0.33	1	A P2 PC	1-year

**PARTS INCLUDED IN KITS ABOVE**

KIT #	Included Parts	KIT #	Included Parts
10520R	10202R light, 10700 grommet, 94902 plug	10004R	10720 bracket, 94902 grommet
10520Y	10202Y light, 10700 grommet, 94902 plug	10004Y	10720 bracket, 94902 grommet

# 10<sup>®</sup> SERIES, INCANDESCENT, GROMMET MOUNT, BEEHIVE

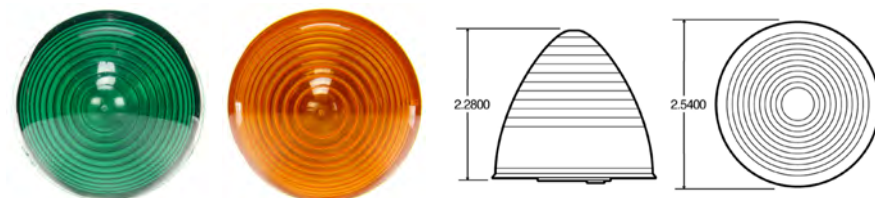

- Features a beehive lens designed for cab marker use
- Lens and housing are sonically sealed
- High impact polycarbonate construction
- 12 volt, 15,000-hour-rated bulb
- Suitable for PC requirements on a 45-degree angle in mounting devices #10708, #10720, #00801, #00803, or #00804
- Upgrade to LED use Truck-Lite part no. 10276R/Y or Signal-Stat part no. 1075/1075A

Part Number	Lens Color	Lamp Connector	Volts	Amps	Bulbs	Lighting Codes	Warranty
10203B	Blue	PL-10	12	0.33	1	P2 P3 PC	1-year
10203G	Green	PL-10	12	0.33	1	P2 P3 PC	1-year
10203R	Red	PL-10	12	0.33	1	P2 P3 PC	1-year
10203Y	Yellow	PL-10	12	0.33	1	P2 P3 PC	1-year

INCANDESCENT

10 SERIES

INCANDESCENT

10 SERIES

## SUPER 10® SERIES, INCANDESCENT, GROMMET MOUNT

- Unique shock-mount extends bulb life
- 15,000-hour-rated bulb life
- Sealed polycarbonate lens and housing
- Meets PC requirements on a 45-degree angle using all mounting devices

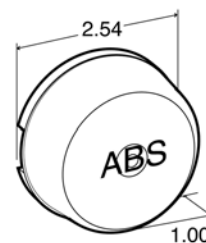

Part Number	Lens Color	Lamp Connector	Volts	Amps	Bulbs	Lighting Codes	Warranty
10212Y	Yellow	PL-10	12	0.33	1	P2 PC	2-year
10213Y	Yellow	PL-10	12	0.33	1	P2 PC	2-year

INCANDESCENT

SUPER 10 SERIES

## SUPER 10® SERIES, INCANDESCENT, GROMMET MOUNT, KIT



- Unique shock-mount extends bulb life
- 15,000-hour-rated bulb life
- Sealed polycarbonate lens and housing
- Meets PC requirements on a 45-degree angle using all mounting devices

### AVAILABLE CONNECTORS

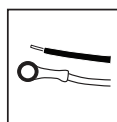

RING TERMINAL / STRIPPED END

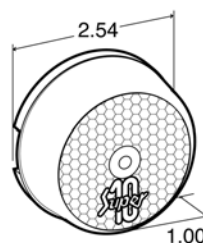

Part Number	Lens Color	Mount Color	Lamp Connector	Plug Side 1	Plug Side 2	Volts	Amps	Bulbs	Lighting Codes	Warranty
10028R	Red	Black	PL-10	PL-10	Ring Terminal/Stripped End	12	0.33	1	P2 PC	2-year
10028Y	Yellow	Black	PL-10	PL-10	Ring Terminal/Stripped End	12	0.33	1	P2 PC	2-year

### PARTS INCLUDED IN KITS ABOVE

KIT #	Included Parts
10028R	10208r light, 10700 grommet, 94902 plug
10028Y	10208y light, 10700 grommet, 94902 plug

## SUPER 10® SERIES, INCANDESCENT, GROMMET MOUNT, REFLECTORIZED

- Unique shock-mount extends bulb life
- 15,000-hour-rated bulb life
- Sealed polycarbonate lens and housing
- Meets PC requirements on a 45 degree angle using all mounting devices

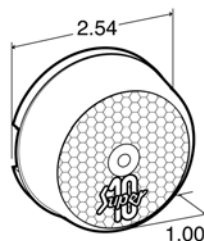

Part Number	Lens Color	Lamp Connector	Volts	Amps	Bulbs	Lighting Codes	Warranty
10208R	Red	PL-10	12	0.33	1	A P2 PC	2-year
10208Y	Yellow	PL-10	12	0.33	1	A P2 PC	2-year

INCANDESCENT

SUPER 10 SERIES

# 12<sup>®</sup> SERIES, INCANDESCENT, BRACKET MOUNT, KIT

INCANDESCENT

12 SERIES

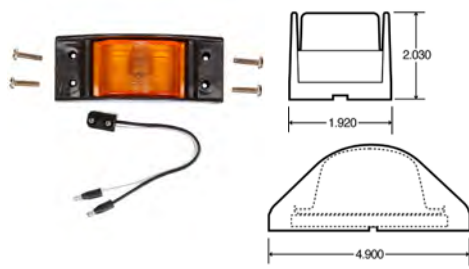

**AVAILABLE CONNECTORS**

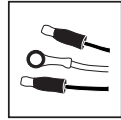

.180 BULLET/  
RING TERMINAL

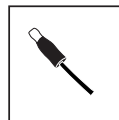

.156 BULLET

- High-impact plastic branch deflector mount
- Snap-in lamp design for easy replacement
- SAE PC-rated for combination clearance/marker applications
- Standard replacement on UPS models



Part Number	Lens Color	Mount Color	Lamp Connector	Plug Side 1	Plug Side 2	Volts	Amps	Bulbs	Lighting Codes	Warranty
12004R	Red	Brown	PL-10			12	0.33	1	P2 PC	1-year
12004Y	Yellow	Brown	PL-10			12	0.33	1	P2 PC	1-year
12001R	Red	Brown	PL-10	PL-10	.156 Bullet	12	0.33	1	P2 PC	1-year
12001Y	Yellow	Brown	PL-10	PL-10	.156 Bullet	12	0.33	1	P2 PC	1-year
12003R	Red	Gray	PL-10	PL-10	Ring Terminal/ Stripped End	12	0.33	1	P2 PC	1-year
12003Y	Yellow	Gray	PL-10	PL-10	Ring Terminal/ Stripped End	12	0.33	1	P2 PC	1-year

**PARTS INCLUDED IN KITS ABOVE**

KIT #	Included Parts
12004R	12200R light, 12724 bracket
12004Y	12200Y light, 12724 bracket
12001R	12200R light, 94850 plug
12001Y	12200Y light, 94850 plug
12003R	12200R light, 12723 bracket, 94919 plug
12003Y	12200Y light, 12723 bracket, 94919 plug

# 12<sup>®</sup> SERIES, INCANDESCENT, GROMMET MOUNT

INCANDESCENT

12 SERIES

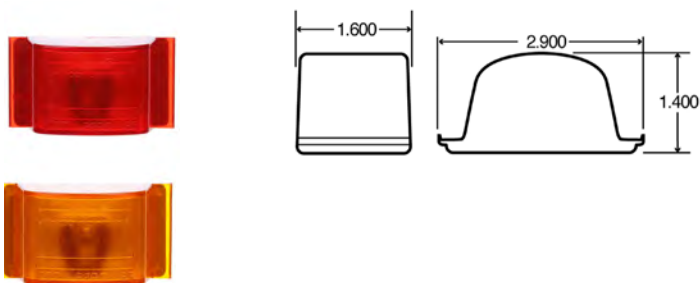

- Features a beehive lens designed for cab marker use
- Lens and housing are sonically sealed
- High impact polycarbonate construction
- 12 volt, 15,000-hour-rated bulb
- Suitable for PC requirements on a 45-degree angle in mounting devices #10708, #10720, #00801, #00803, or #00804
- Upgrade to LED use Truck-Lite part #10276R/Y or Signal-Stat part #1075/1075A

Part Number	Lens Color	Lamp Connector	Volts	Amps	Bulbs	Lighting Codes	Warranty
12200R	Red	PL-10	12	0.33	1	P2 PC	1-year
12200Y	Yellow	PL-10	12	0.33	1	P2 PC	1-year
12201R	Red	PL-10	24	0.17	1	P2 PC	1-year
12201Y	Yellow	PL-10	24	0.17	1	P2 PC	1-year

### 13 SERIES, INCANDESCENT, BOLT & NUT MOUNT

- Sonically sealed lens and housing protect a heavy-duty, shock-mounted, single-filament bulb
- High-impact polycarbonate construction
- Functions include front outline marker (clear), ABS warning (green), end outline marker (red) and side marker (yellow)

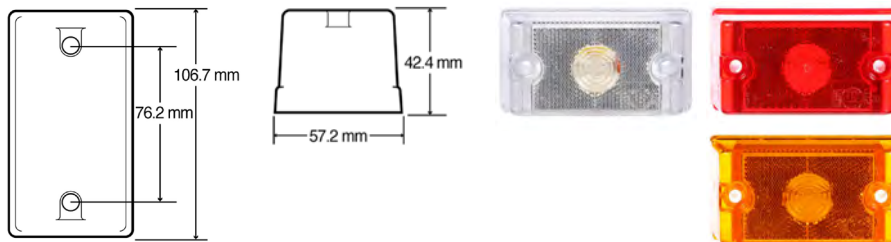

Part Number	Lens Color	Mount Color	Lamp Connector	Volts	Amps	Bulbs	Lighting Codes	Warranty
13200C	Clear	Clear	Super 21 Plug	24	0.35	1	E1	1-year
13200R	Red	Red	Super 21 Plug	24	0.35	1	E1	1-year
13200Y	Yellow	Yellow	Super 21 Plug	24	0.35	1	E1	1-year
13210C	Clear	Clear	Super 21 Plug	12	0.69	1	E1	1-year
13210R	Red	Red	Super 21 Plug	12	0.69	1	E1	1-year
13210Y	Yellow	Yellow	Super 21 Plug	12	0.69	1	E1	1-year

### 13 SERIES, INCANDESCENT, BOLT & NUT MOUNT, KIT



- Sonically sealed lens and housing protect a heavy-duty, shock-mounted, single-filament bulb
- High-impact polycarbonate construction
- Functions include front outline marker (clear), ABS warning (green), end outline marker (red) and side marker (yellow)

**AVAILABLE CONNECTORS**

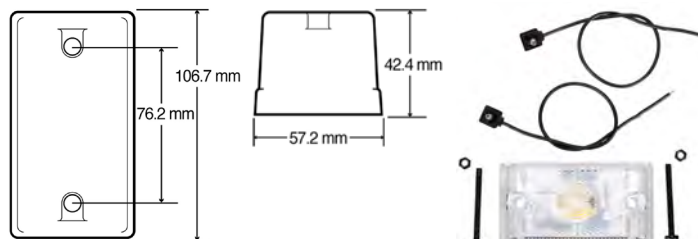
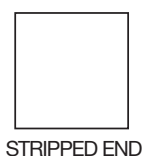

Part Number	Lens Color	Mount Color	Lamp Connector	Plug Side 1	Plug Side 2	Volts	Amps	Bulbs	Lighting Codes	Warranty
13001R	Red	Red	Super 21 Plug	Super 21 Plug	Stripped End	24	0.35	1	E1	1-year
13001Y	Yellow	Yellow	Super 21 Plug	Super 21 Plug	Stripped End	24	0.35	1	E1	1-year
13011C	Clear	Clear	Super 21 Plug	Super 21 Plug	Stripped End	12	0.69	1	E1	1-year
13011R	Red	Red	Super 21 Plug	Super 21 Plug	Stripped End	12	0.69	1	E1	1-year
13011Y	Yellow	Yellow	Super 21 Plug	Super 21 Plug	Stripped End	12	0.69	1	E1	1-year
13001C	Clear	White	Super 21 Plug	Super 21 Plug	Stripped End	24	0.35	1	E1	1-year
13001G	Green	Clear	Super 21 Plug	Super 21 Plug	Stripped End	24	0.35	1	E1	1-year

**PARTS INCLUDED IN KITS ABOVE**

KIT #	Included Parts
13001R	13200R light, 96930 plug
13001Y	13200Y light, 96930 plug
13011C	13210C light, 95911 hardware, 96930 plug
13011R	13210C light, 95911 hardware, 96930 plug

KIT #	Included Parts
13011Y	13210C light, 95911 hardware, 96930 plug
13001C	13200C light, 96930 plug
13001G	13200C light, 96930 plug

## 14 SERIES, INCANDESCENT, GROMMET MOUNT, REFLECTORIZED

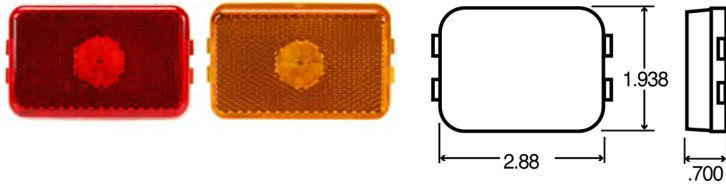

- Sonically sealed lens and housing
- Features snap-in lamp with reflector
- 12 and 24-volt versions available
- Long-life, 15,000-hour, 12 volt bulb
- Grommets flush-mount the lamp to vehicle
- Not suitable for PC requirements
- Replaces Signal-Stat 1017/1017A and 9138

Part Number	Lens Color	Lamp Connector	Volts	Amps	Bulbs	Lighting Codes	Warranty
14200R	Red	PL-10	12	0.33	1	A P2	1-year
14200Y	Yellow	PL-10	12	0.33	1	A P2	1-year

## 15<sup>®</sup> SERIES, INCANDESCENT, BRACKET MOUNT



- Fits in most narrow header rails
- Mounts vertically or horizontally
- Long-life, 15,000-hour bulb
- Snap-lock tabs allow quick and easy installation
- Suitable for PC requirements on a 45-degree angle

Part Number	Lens Color	Lamp Connector	Volts	Amps	Bulbs	Lighting Codes	Warranty
15200R	Red	PL-10	12	0.33	1	P2 PC	2-year
15200Y	Yellow	PL-10	12	0.33	1	P2 PC	2-year
15201R	Red	PL-10	24	0.17	1	P2 PC	2-year
15201Y	Yellow	PL-10	24	0.17	1	P2 PC	2-year

## 15<sup>®</sup> SERIES, INCANDESCENT, BRACKET MOUNT, ABS

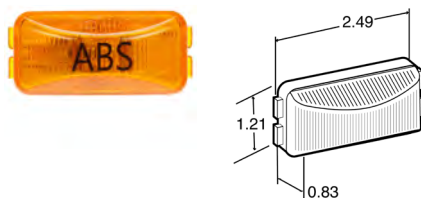

- Fits in most narrow header rails
- Mounts vertically or horizontally
- Long-life, 15,000-hour bulb
- Snap-lock tabs allow quick and easy installation.
- Suitable for PC requirements on a 45-degree angle

Part Number	Lens Color	Lamp Connector	Volts	Amps	Bulbs	Lighting Codes	Warranty
15203Y	Yellow	PL-10	12	0.33	1	P2 PC	2-year



# 15<sup>®</sup> SERIES, INCANDESCENT, BRACKET MOUNT, KIT



- Extra-strength plastic construction
- Features top cut-out area on mount #15727 for narrow rail design
- Easy snap-in lamp installation
- Suitable for PC requirements with incandescent lamps

### AVAILABLE CONNECTORS



RING TERMINAL / STRIPPED END



BLUNT CUT



STRIPPED END

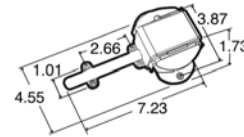

Part Number	Lens Color	Mount Color	Lamp Connector	Plug Side 1	Plug Side 2	Volts	Amps	Bulbs	Lighting Codes	Warranty
15006R	Red	White	PL-10	PL-10	Ring Terminal/Stripped End	12	0.33	1	P2 PC	1-year
15006Y	Yellow	White	PL-10	PL-10	Ring Terminal/Stripped End	12	0.33	1	P2 PC	1-year
15008R	Red	White	PL-10	PL-10	Ring Terminal/Stripped End	12	0.33	1	P2 PC	1-year
15008Y	Yellow	White	PL-10	PL-10	Ring Terminal/Stripped End	12	0.33	1	P2 PC	1-year
15415	Red Yellow	Black	Fit 'N Forget M/C	Fit 'N Forget M/C	Blunt Cut	12	0.33	1	P2 PC	1-year
15416	Red Yellow	Black	Fit 'N Forget M/C	Fit 'N Forget M/C	Blunt Cut	12	0.33	1	P2 PC	1-year
15506R	Red	Chrome	.156 Bullet Hot Wire	.156 Bullet Hot Wire	Stripped End	12	0.33	1	P2 PC	1-year
15506Y	Yellow	Chrome	.156 Bullet Hot Wire	.156 Bullet Hot Wire	Stripped End	12	0.33	1	P2 PC	1-year
15507R	Red	Black	.156 Bullet Hot Wire	.156 Bullet Hot Wire	Stripped End	12	0.33	1	P2 PC	1-year
15507Y	Yellow	Black	.156 Bullet Hot Wire	.156 Bullet Hot Wire	Stripped End	12	0.33	1	P2 PC	1-year

### PARTS INCLUDED IN KITS ABOVE

KIT #	Included Parts
15006R	15200R light, 15727 bracket, 94924 plug
15006Y	15200Y light, 15727 bracket, 94924 plug
15008R	15200R light, 15728 bracket, 94924 plug
15008Y	15200Y light, 15728 bracket, 94924 plug
15415	15200R light, 15731 bracket

KIT #	Included Parts
15416	15200Y light, 15731 bracket
15506R	15200R light, 793 bracket, 96904 plug
15506Y	15200Y light, 793 bracket, 96904 plug
15507R	15200R light, 809 bracket
15507Y	15200Y light, 809 bracket

# 18<sup>®</sup> SERIES, INCANDESCENT, 2 SCREW, REFLECTORIZED, KIT



- Sonically welded lens and housing
- Replaceable bulb
- Not suitable for PC requirements
- Replaces Signal-Stat 1572/1572A

### AVAILABLE CONNECTORS



RING TERMINAL / STRIPPED END

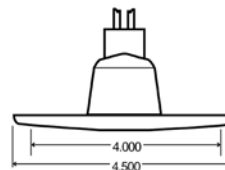
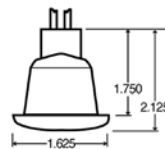

Part Number	Lens Color	Mount Color	Lamp Connector	Plug Side 1	Plug Side 2	Volts	Amps	Bulbs	Lighting Codes	Warranty
18300R	Red	Red	Socket Assembly	Socket Assembly	Ring Terminal/Stripped End	12	0.27	1	A P2	1-year
18300Y	Yellow	Yellow	Socket Assembly	Socket Assembly	Ring Terminal/Stripped End	12	0.27	1	A P2	1-year

### PARTS INCLUDED IN KITS ABOVE

KIT #	Included Parts
18300R	99012R light, 97927 grommet, 94940 plug
18300Y	99012Y light, 97927 grommet, 94940 plug

INCANDESCENT

15 SERIES

INCANDESCENT

18 SERIES

## 19<sup>®</sup> SERIES, INCANDESCENT, 2 SCREW, KIT

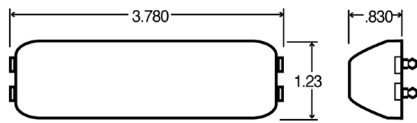

- Features unique plug-in design for ease of installation
- Low profile extra-strength base
- Suitable for pc requirements on a 45-degree angle



Part Number	Lens Color	Mount Color	Lamp Connector	Plug Side 1	Plug Side 2	Volts	Amps	Bulbs	Lighting Codes	Warranty
19002R	Red	Gray	Hardwired	Hardwired	Stripped End	12	0.33	2	P2 PC	1-year
19002Y	Yellow	Gray	Hardwired	Hardwired	Stripped End	12	0.33	2	P2 PC	1-year
19009R	Red	Chrome	Hardwired	Hardwired	Stripped End	12	0.33	2	P2 PC	1-year
19009Y	Yellow	Chrome	Hardwired	Hardwired	Stripped End	12	0.33	2	P2 PC	1-year

### PARTS INCLUDED IN KITS ABOVE

KIT #	Included Parts	KIT #	Included Parts
19002R	19200R light, 19721 bracket	19009R	19200R light, 19739 bracket
19002Y	19200R light, 19721 bracket	19009Y	19200Y light, 19739 bracket

## 19<sup>®</sup> SERIES, INCANDESCENT, BRACKET MOUNT

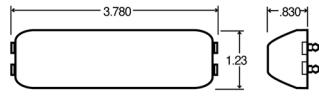

- Designed to fit in limited mounting areas
- Fits in most narrow header rails
- Can be mounted vertically or horizontally
- Snap-lock tabs allow quick and easy installation
- Replaces Signal-Stat 1900 series

Part Number	Lens Color	Lamp Connector	Volts	Amps	Bulbs	Lighting Codes	Warranty
19200R	Red	19 Series Male Pin	12	0.33	2	P2 P3 PC	1-year
19200Y	Yellow	Fit 'N Forget M/C	12	0.33	2	P2 P3 PC	1-year
19205Y	Yellow	Fit 'N Forget M/C	12	0.33	2	P2 P3 PC	1-year

## 19<sup>®</sup> SERIES, INCANDESCENT, BRACKET MOUNT, KIT

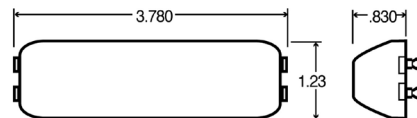

- Features unique plug-in design for ease of installation
- Low profile extra strength base
- Suitable for pc requirements on a 45-degree angle



Part Number	Lens Color	Mount Color	Lamp Connector	Volts	Amps	Bulbs	Lighting Codes	Warranty
19016R	Red	Black	19 Series Male Pin	12	0.33	2	P2 PC	1-year
19016Y	Yellow	Black	19 Series Male Pin	12	0.33	2	P2 PC	1-year

### PARTS INCLUDED IN KITS ABOVE

KIT #	Included Parts
19016R	19200R light, 19728 bracket
19016Y	19200Y light, 19728 bracket

INCANDESCENT

19 SERIES

INCANDESCENT

19 SERIES

INCANDESCENT

19 SERIES

## 21<sup>®</sup> SERIES, INCANDESCENT, 2 SCREW

- Available with standard or reflectorized lens
- Features male pin connections
- Suitable for PC requirements on a 45-degree angle with additional reflectors

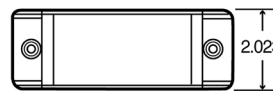
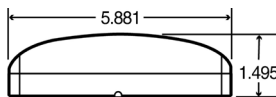

Part Number	Lens Color	Mount Color	Lamp Connector	Volts	Amps	Bulbs	Lighting Codes	Warranty
29202R	Red	Red	Male Pin	12	0.33	2	P2 PC	1-year
29202Y	Yellow	Yellow	Male Pin	12	0.33	2	P2 PC	1-year

INCANDESCENT

21 SERIES

## 21<sup>®</sup> SERIES, INCANDESCENT, 2 SCREW, KIT



- Available with standard or reflectorized lens
- Features male pin connections
- Suitable for PC requirements on a 45-degree angle with additional reflectors

### AVAILABLE CONNECTORS

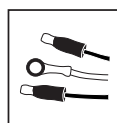

.180 BULLET/  
RING TERMINAL

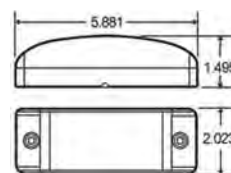

Part Number	Lens Color	Mount Color	Lamp Connector	Plug Side 1	Plug Side 2	Volts	Amps	Bulbs	Lighting Codes	Warranty
29002R	Red	Red	Male Pin	Male Pin	.180 Bullet/ Ring Terminal	12	0.33	2	P2 PC	1-year
29002Y	Yellow	Yellow	Male Pin	Male Pin	.180 Bullet/ Ring Terminal	12	0.33	2	P2 PC	1-year

### PARTS INCLUDED IN KITS ABOVE

KIT #	Included Parts
29002R	29202R light, 96106 plug
29002Y	29202Y light, 96106 plug

INCANDESCENT

21 SERIES

## 21 SERIES, INCANDESCENT, 2 SCREW, REFLECTORIZED

- Available with standard or reflectorized lens
- Features male pin connections
- Suitable for PC requirements on a 45-degree angle with additional reflectors

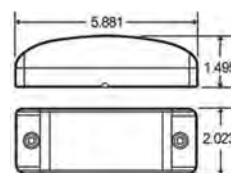

Part Number	Lens Color	Mount Color	Lamp Connector	Volts	Amps	Bulbs	Lighting Codes	Warranty
29203R	Red	Red	Male Pin	12	0.33	2	A P2 PC	1-year
29203Y	Yellow	Yellow	Male Pin	12	0.33	2	A P2 PC	1-year

INCANDESCENT

21 SERIES

## 21<sup>®</sup> SERIES, INCANDESCENT, 2 SCREW, REFLECTORIZED, KIT

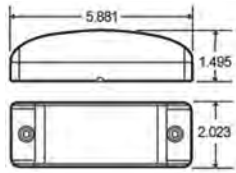

### AVAILABLE CONNECTORS

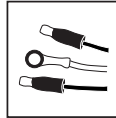

.180 BULLET/  
RING TERMINAL

- Available with standard or reflectorized lens
- Features male pin connections
- Suitable for PC requirements on a 45-degree angle with additional reflectors



Part Number	Lens Color	Mount Color	Lamp Connector	Plug Side 1	Plug Side 2	Volts	Amps	Bulbs	Lighting Codes	Warranty
29003R	Red	Red	Male Pin	Male Pin	.180 Bullet/ Ring Terminal	12	0.33	2	A P2 PC	1-year
29003Y	Yellow	Yellow	Male Pin	Male Pin	.180 Bullet/ Ring Terminal	12	0.33	2	A P2 PC	1-year

### PARTS INCLUDED IN KITS ABOVE

KIT #	Included Parts
29003R	29203R light, 96106 plug
29003Y	29203Y light, 96106 plug

## SUPER 21<sup>®</sup> SERIES, INCANDESCENT, 2 SCREW

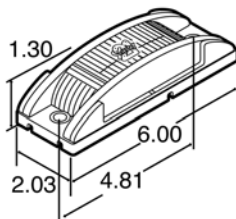

- Available with standard or reflectorized lens
- Suitable for PC requirements on a 45-degree angle with additional reflectors
- Version available for ABS requirements
- Optional gaskets available to improve seal between lamp and body
- Kits with extension brackets are a direct replacement for Utility Trailer #03-5100-0-097/8

Part Number	Lens Color	Mount Color	Lamp Connector	Volts	Amps	Bulbs	Lighting Codes	Warranty
21200R	Red	Red	Super 21 Plug	12	0.33	1	P2 PC	2-year
21200Y	Yellow	Yellow	Super 21 Plug	12	0.33	1	P2 PC	2-year
21205R	Red	Red	Super 21 Plug	24	0.17	1	P2 PC	2-year
21205Y	Yellow	Yellow	Super 21 Plug	24	0.17	1	A P2 PC	2-year
21210Y	Yellow	Yellow	Super 21 Plug	12	0.33	1	P2 PC	2-year
21506R	Red	Red	Self-Piercing Plug	12	0.33	1	P2 PC	2-year
21506Y	Yellow	Yellow	Self-Piercing Plug	12	0.33	1	P2 PC	2-year

INCANDESCENT

21 SERIES

INCANDESCENT

SUPER 21 SERIES

# SUPER 21® SERIES, INCANDESCENT, 2 SCREW, KIT



- Available with standard or reflectorized lens
- Suitable for PC requirements on a 45-degree angle with additional reflectors
- Version available for ABS requirements
- Optional gaskets available to improve seal between lamp and body
- Kits with extension brackets are a direct replacement for Utility Trailer #03-5100-0-097/8

**AVAILABLE CONNECTORS**

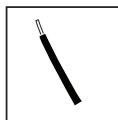

STRIPPED END

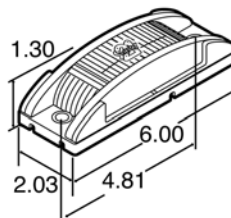

Part Number	Lens Color	Mount Color	Lamp Connector	Plug Side 1	Plug Side 2	Volts	Amps	Bulbs	Lighting Codes	Warranty
21001R	Red	Red	Super 21 Plug	Super 21 Plug	Stripped End	12	0.17	1	P2 PC	2-year
21001Y	Yellow	Yellow	Super 21 Plug	Super 21 Plug	Stripped End	12	0.17	1	P2 PC	2-year
21005R	Red	Red	Super 21 Plug	Super 21 Plug	Stripped End	24	0.17	1	P2 PC	2-year
21005Y	Yellow	Yellow	Super 21 Plug	Super 21 Plug	Stripped End	24	0.17	1	P2 PC	2-year

**PARTS INCLUDED IN KITS ABOVE**

KIT #	Included Parts
21001R	21200R light, 96930 plug
21001Y	21200Y light, 96930 plug
21005R	21205R light, 96930 plug
21005Y	21205Y light, 96930 plug

# SUPER 21® SERIES, INCANDESCENT, 2 SCREW, REFLECTORIZED

- Available with standard or reflectorized lens
- Suitable for PC requirements on a 45-degree angle with additional reflectors
- Version available for ABS requirements
- Optional gaskets available to improve seal between lamp and body
- Kits with extension brackets are a direct replacement for Utility Trailer #03-5100-0-097/8

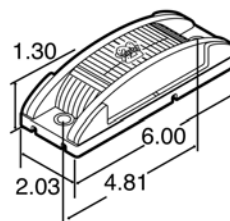

Part Number	Lens Color	Mount Color	Lamp Connector	Volts	Amps	Bulbs	Lighting Codes	Warranty
21201R	Red	Red	Super 21 Plug	12	0.33	1	A P2	2-year
21201Y	Yellow	Yellow	Super 21 Plug	12	0.33	1	A P2	2-year

INCANDESCENT

SUPER 21 SERIES

INCANDESCENT

SUPER 21 SERIES

INCANDESCENT

SUPER 21 SERIES

# SUPER 21® SERIES, INCANDESCENT, 2 SCREW, KIT, REFLECTORIZED

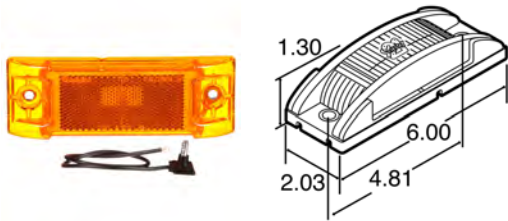

AVAILABLE CONNECTORS

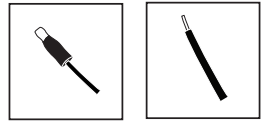

.180 BULLET STRIPPED END

- Available with standard or reflectorized lens
- Suitable for PC requirements on a 45-degree angle with additional reflectors
- Version available for ABS requirements
- Optional gaskets available to improve seal between lamp and body
- Kits with extension brackets are a direct replacement for Utility Trailer #03-5100-0-097/8

Part Number	Lens Color	Mount Color	Lamp Connector	Plug Side 1	Plug Side 2	Volts	Amps	Bulbs	Lighting Codes	Warranty
21002R	Red	Red	Super 21 Plug	Super 21 Plug	Stripped End	12	0.33	1	A P2	2-year
21002Y	Yellow	Yellow	Super 21 Plug	Super 21 Plug	Stripped End	12	0.33	1	A P2	2-year
21501R	Red	Red	Super 21 Plug	Super 21 Plug	.180 Bullet	12	0.33	1	A P2 PC	2-year
21501Y	Yellow	Yellow	Super 21 Plug	Super 21 Plug	.180 Bullet	12	0.33	1	A P2 PC	2-year

PARTS INCLUDED IN KITS ABOVE

KIT #	Included Parts
21002R	21201R light, 96930 plug

KIT #	Included Parts
21002Y	21201Y light, 96930 plug

SUPER 21 SERIES

# SUPER 21® SERIES, INCANDESCENT, 2 SCREW, KIT, REFLECTORIZED, SELF-PIERCING PLUG

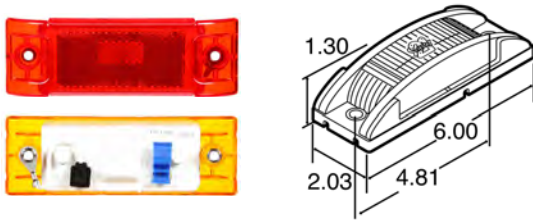

- Available with standard or reflectorized lens.
- Suitable for PC requirements on a 45-degree angle with additional reflectors.
- Version available for ABS requirements.
- Optional gaskets available to improve seal between lamp and body.
- Kits with extension brackets are a direct replacement for Utility Trailer #03-5100-0-097/8

Part Number	Lens Color	Mount Color	Lamp Connector	Volts	Amps	Bulbs	Lighting Codes	Warranty	Included Parts
21507R	Red	Red	Self-Piercing Plug	12	0.33	1	A P2	2-year	21201R light
21507Y	Yellow	Yellow	Self-Piercing Plug	12	0.33	1	A P2	2-year	21201Y light

INCANDESCENT

25 SERIES

# 25® SERIES, INCANDESCENT, 2 SCREW

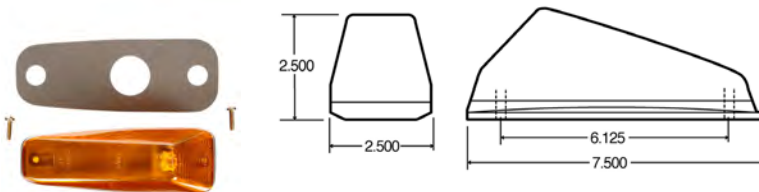

- Features surface mount design for replacement on many Ford trucks
- Contains #94940 plug assembly and one #194 wedge base bulb
- Lens and housing are sonically sealed
- Suitable for PC requirements on a 45-angle
- Replaces Signal-Stat 1360A

Part Number	Lens Color	Mount Color	Lamp Connector	Plug Side 1	Plug Side 2	Volts	Amps	Bulbs	Lighting Codes	Warranty
25760Y	Yellow	Gray	Socket Assembly	Socket Assembly	Ring Terminal/ Stripped End	12	0.27	1	P2 PC	1-year
25761Y	Yellow	Gray	Socket Assembly	Socket Assembly	Ring Terminal/ Stripped End	12	0.27	1	P2 PC	1-year
25780R	Red	Black	Socket Assembly	Socket Assembly	2 Position .180 Bullet Terminal	12	0.27	1	P2 PC	1-year

## 25<sup>®</sup> SERIES, INCANDESCENT, 2 STUD MOUNT

- Aerodynamic design for replacement on Ford trucks #F81B-15442-A
- Screw on polycarbonate lens and housing
- Mounts on 1-3/4" centers with foam gasket seal and M5 mounting studs
- Suitable for PC requirements on a 45-degree angle

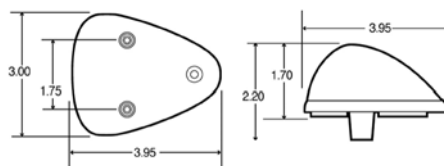

Part Number	Lens Color	Lamp Connector	Volts	Amps	Bulbs	Lighting Codes	Warranty
25762Y	Yellow	AMP 174928-1	12	0.27	1	P2 PC	1-year

INCANDESCENT

25 SERIES

## 25<sup>®</sup> SERIES, INCANDESCENT, 2 STUD MOUNT, KIT



- Aerodynamic design for replacement on Ford trucks #F81B-15442-A
- Screw-on polycarbonate lens and housing
- Mounts on 1-3/4" centers with foam gasket seal and M5 mounting studs
- Kit includes #95119 plug assembly to connect socket (mating to AMP 174928-1)
- Suitable for PC requirements on a 45-degree angle

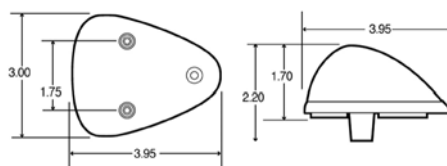

Part Number	Lens Color	Lamp Connector	Plug Side 1	Plug Side 2	Volts	Amps	Bulbs	Lighting Codes	Warranty
25062Y	Yellow	AMP 174921-1	AMP 174928-1	Stripped End	12	0.27	1	P2 PC	1-year

INCANDESCENT

25 SERIES

### PARTS INCLUDED IN KITS ABOVE

KIT #	Included Parts
25062Y	25762Y light, 95119 plug

## 25<sup>®</sup> SERIES, LED, 2 SCREW, REFLECTORIZED, SOCKET ASSEMBLY

- Features surface-mount design for replacement on Mack trucks
- Sonically sealed lens and housing
- Mounting gasket included to improve seal of lamp and body
- Recommend Truck-Lite's #94940 plug and #194 bulb
- Not suitable for PC requirements
- Upgrade to LED using part #25250R/Y

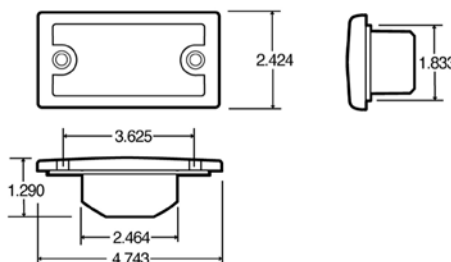

Part Number	Lens Color	Mount Color	Lamp Connector	Lighting Codes	Warranty
25765Y	Yellow	Yellow	Socket Assembly	A P2 PC	1-year
25766R	Red	Red	Socket Assembly	A P2 PC	1-year
25766Y	Yellow	Yellow	Socket Assembly	A P2 PC	1-year

INCANDESCENT

25 SERIES

## 26 SERIES, INCANDESCENT, BRACKET MOUNT, KIT



- Surface mounts on two screws at 1.5" centers
- Ground-through base
- Popular for use on school and commercial buses
- Heavy-duty steel and acrylic construction
- Lens attaches to base with one center screw
- Optional zinc-plated steel guard provides additional protection



Part Number	Lens Color	Mount Color	Lamp Connector	Plug Side 1	Plug Side 2	Volts	Amps	Bulbs	Lighting Codes	Warranty
26311R	Red	Silver	Hardwired	Hardwired	Stripped End	12	0.35	1	P2 PC	1-year
26311Y	Yellow	Silver	Hardwired	Hardwired	Stripped End	12	0.35	1	P2 PC	1-year
26313R	Red	Silver	Hardwired	Hardwired	Stripped End	12	0.35	2	P2 PC	1-year
26313Y	Yellow	Silver	Hardwired	Hardwired	Stripped End	12	0.35	2	P2 PC	1-year
26315R	Red	Silver	Hardwired	Hardwired	Stripped End	12	0.27	1	P2 PC	1-year
26315Y	Yellow	Silver	Hardwired	Hardwired	Stripped End	12	0.27	1	P2 PC	1-year
26353R	Red		Hardwired	Hardwired	Stripped End	12	0.35	1	P2 PC	3-year
26353Y	Yellow		Hardwired	Hardwired	Stripped End	12	0.35	1	P2 PC	3-year

### PARTS INCLUDED IN KITS ABOVE

KIT #	Included Parts	KIT #	Included Parts
26311R	99160r lens	26315R	8930 lens
26311Y	99160y lens	26315Y	8930a lens
26313R	99160r lens	26353R	99170r lens
26313Y	99160y lens	26353Y	99170y lens

## 26 SERIES, INCANDESCENT, 2 SCREW, BEEHIVE

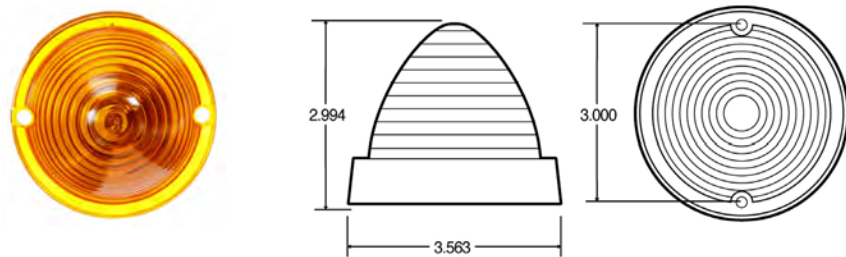

- Features a beehive lens designed for cab marker use
- Lens and housing are sonically sealed
- High impact polycarbonate construction

Part Number	Lens Color	Lamp Connector	Volts	Amps	Bulbs	Lighting Codes	Warranty
26762Y	Yellow	PL-10	12	0.33	1	P2 PC	1-year



## 26 SERIES, INCANDESCENT, 2 SCREW, KIT, BEEHIVE



- Features chrome-plated plastic housing with contour base and rubber mounting pad
- Includes one #67 bulb

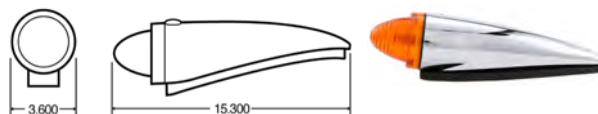

Part Number	Lens Color	Mount Color	Lamp Connector	Plug Side 1	Plug Side 2	Volts	Amps	Bulbs	Lighting Codes	Warranty
26760Y	Yellow	Silver	Hardwired	Hardwired	Ring Terminal/ Stripped End	12	0.35	1	P2 PC	1-year

### PARTS INCLUDED IN KITS ABOVE

KIT #	Included Parts
26760Y	99066Y lens, 97046 pad, 97905 grommet

## 26 SERIES, INCANDESCENT, 2 SCREW, OVAL

- Innovative lamp design allows one lamp the ability to function as two
- Lamp is designed to comply with SAE J2042 requirements when mounted both horizontally and vertically
- Newly designed wire grommet provides improved water resistance between the lamp and wiring
- Polycarbonate lens offers added impact and heat resistance

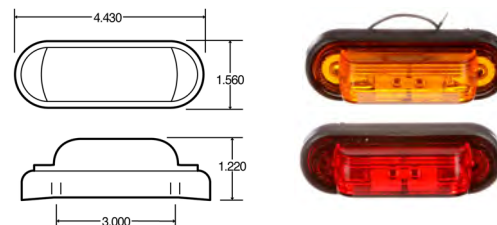

Part Number	Lens Color	Mount Color	Lamp Connector	Plug Side 1	Plug Side 2	Volts	Amps	Bulbs	Lighting Codes	Warranty
26901Y	Yellow		Hardwired	Hardwired	.180 Bullet	12	0.5	2	P2 P3 PC	1-year
26310R	Red	Black	Hardwired	Hardwired	Stripped End	12	0.27	2	P2 PC	1-year
26310Y	Yellow	Black	Hardwired	Hardwired	Stripped End	12	0.27	2	P2 PC	1-year
26312R	Red	Red	Hardwired	Hardwired	Stripped End	12	0.27	2	P2 PC	1-year
26312Y	Yellow	Yellow	Hardwired	Hardwired	Stripped End	12	0.27	2	P2 PC	1-year

## 26 SERIES, INCANDESCENT, 2 SCREW, RECTANGULAR

- High-impact Permastat housing protects against rust and corrosion
- Shock/Mount (1213 model) for maximum bulb life
- Snap-on lens makes bulb and lens replacement easy
- Two bulb design-if one burns out, the other remains lighted
- Lamp meets requirements with only one bulb
- Not suitable for PC requirements
- Replaces Truck-Lite 26302 series

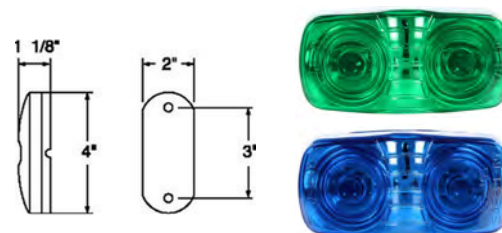

Part Number	Lens Color	Lamp Connector	Plug Side 1	Plug Side 2	Volts	Amps	Bulbs	Warranty
26302B	Blue	Hardwired	Hardwired	Stripped End	12	0.27	2	1-year
26302G	Green	Hardwired	Hardwired	Stripped End	12	0.27	2	1-year

INCANDESCENT

26 SERIES

INCANDESCENT

26 SERIES

## 26 SERIES, INCANDESCENT, 2 SCREW, ROUND

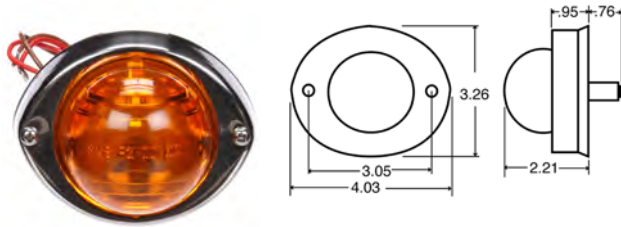

- Popular in bus applications
- Provide marker and auxiliary side-turn indicator functions
- Features stainless steel and two holes for #10 screws on 1.625" centers
- Clearance hole of .812 diameter required

Part Number	Lens Color	Mount Color	Lamp Connector	Plug Side 1	Plug Side 2	Volts	Amps	Bulbs	Lighting Codes	Warranty
26390Y	Yellow	Silver	Hardwired	Hardwired	Stripped End	12	0.27	1	P2	1-year

## 26 SERIES, INCANDESCENT, 2 SCREW, TRIANGLE

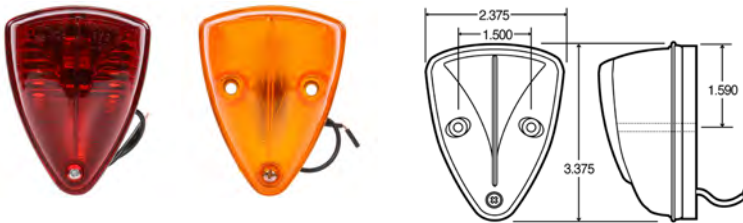

- Surface mounts on two pass-through lens screws at 1.5" centers
- Ground-through base
- Popular for use on school buses and commercial vehicles
- Heavy-duty steel and acrylic construction
- Lens attaches to base with one screw
- Optional zinc-plated steel guard provides additional protection

Part Number	Lens Color	Mount Color	Lamp Connector	Plug Side 1	Plug Side 2	Volts	Amps	Bulbs	Lighting Codes	Warranty
26771Y	Yellow	Black	Hardwired	Hardwired	Stripped End	12	0.69	1	P2 PC	1-year
26354R	Red	Silver	Hardwired	Hardwired	Stripped End	12	0.69	1	P2 PC	1-year
26354Y	Yellow	Steel	Hardwired	Hardwired	Stripped End	12	0.69	1	P2 PC	1-year
26765R	Red	Black	Socket Assembly	Socket Assembly	Stripped End	12	0.59	1	P2 PC	1-year
26765Y	Yellow	Black	Socket Assembly	Socket Assembly	Stripped End	12	0.59	1	P2 PC	1-year
26771R	Red	Black	Hardwired	Hardwired	Stripped End	12	0.69	1	P2 PC	1-year

## 26 SERIES, INCANDESCENT, BRACKET MOUNT, OVAL

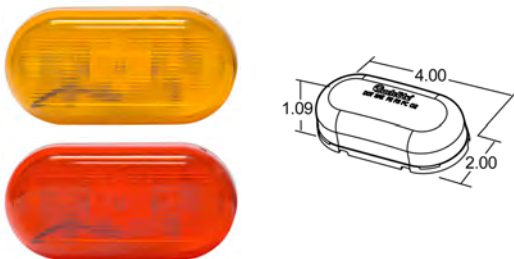

- Innovative lamp design allows one lamp the ability to function as two
- Lamp is designed to comply with SAE J2042 requirements when mounted both horizontally and vertically
- Newly designed wire grommet provides improved water resistance between the lamp and wiring
- Polycarbonate lens offers added impact and heat resistance

Part Number	Lens Color	Mount Color	Lamp Connector	Plug Side 1	Plug Side 2	Volts	Amps	Bulbs	Lighting Codes	Warranty
26901R	Red	White	Hardwired	Hardwired	.180 Bullet	12	0.5	2	P2 P3 PC	1-year
26902R	Red	White	Hardwired	Hardwired	.180 Bullet	12	0.5	2	P2 P3 PC	1-year
26902Y	Yellow		Hardwired	Hardwired	.180 Bullet	12	0.5	2	P2 P3 PC	1-year

INCANDESCENT

26 SERIES

INCANDESCENT

26 SERIES

INCANDESCENT

26 SERIES

### 30<sup>®</sup> SERIES, INCANDESCENT, GROMMET MOUNT

- Wabash and Monon replacement
- “ABS” version complies with FMVSS 108 requirement for ABS malfunction indicator lamp on trailer and ABS braking systems
- 12 volt, 15,000-hour-rated bulb life
- Lamp designed for PC requirements on a 45-degree angle in mounting devices #30720, #00801, #00803, #00804 or surface-mount flange

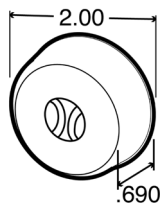

Part Number	Lens Color	Lamp Connector	Volts	Amps	Bulbs	Lighting Codes	Warranty
30200B	Blue	PL-10	12	0.33	1		1-year
30200G	Green	PL-10	12	0.33	1		1-year
30200R	Red	PL-10	12	0.33	1	P2 P3 PC	1-year
30200Y	Yellow	PL-10	12	0.33	1	P2 P3 PC	1-year
30204R	Red	PL-10	12	0.33	1	P2 PC	1-year
30204Y	Yellow	PL-10	12	0.33	1	P2 PC	1-year
30206G	Green	PL-10	24	0.17	1		1-year
30206R	Red	PL-10	24	0.17	1	P2 P3 PC	1-year
30206Y	Yellow	PL-10	24	0.17	1	P2 P3 PC	1-year
30230Y	Yellow	PL-10	12	0.33	1	P2 P3 PC	1-year
30257Y	Yellow	PL-10	12	0.33	1	P2 P3 PC	1-year

### 30<sup>®</sup> SERIES, INCANDESCENT, GROMMET MOUNT, KIT



- Wabash and Monon replacement
- “ABS” version complies with FMVSS 108 requirement for ABS malfunction indicator lamp on trailer and ABS braking systems
- 12 volt, 15,000-hour-rated bulb life
- Lamp designed for PC requirements on a 45-degree angle in mounting devices #30720, #00801, #00803, #00804 or surface mount flange

AVAILABLE CONNECTORS

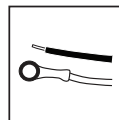

RING TERMINAL / STRIPPED END

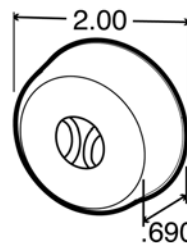

Part Number	Lens Color	Mount Color	Lamp Connector	Plug Side 1	Plug Side 2	Volts	Amps	Bulbs	Lighting Codes	Warranty
30503R	Red	Black	PL-10	PL-10	Ring Terminal/Stripped End	12	0.33	1	P2 P3 PC	1-year
30503Y	Yellow	Black	PL-10	PL-10	Ring Terminal/Stripped End	12	0.33	1	P2 P3 PC	1-year

PARTS INCLUDED IN KITS ABOVE

KIT #	Included Parts
30503R	30200R light, 30700 grommet, 94902 plug
30503Y	30200Y light, 30700 grommet, 94902 plug

INCANDESCENT

30 SERIES

INCANDESCENT

30 SERIES

## 30<sup>®</sup> SERIES, INCANDESCENT, BRACKET MOUNT, KIT

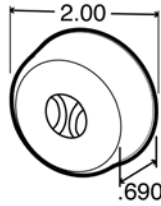

### AVAILABLE CONNECTORS

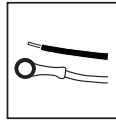

RING TERMINAL  
/ STRIPPED END

- Rust-resistant stainless steel mount
- Quick cam-on, cam-off lamp installation
- Meets PC requirements on a 45-degree angle
- Mounts with screws to surface, not included
- Not recommended for Signal-Stat LED lamps

**KIT**

Part Number	Lens Color	Mount Color	Lamp Connector	Plug Side 1	Plug Side 2	Volts	Amps	Bulbs	Lighting Codes	Warranty
30001R	Red	Silver	PL-10	PL-10	Stripped End/ Ring Terminal	12	0.33	1	P2 PC	1-year
30001Y	Yellow	Silver	PL-10	PL-10	Stripped End/ Ring Terminal	12	0.33	1	P2 PC	1-year
30504R	Red	Gray	PL-10	PL-10	Ring Terminal/ Stripped End	12	0.33	1	P2 P3 PC	1-year
30504Y	Yellow	Gray	PL-10	PL-10	Ring Terminal/ Stripped End	12	0.33	1	P2 P3 PC	1-year

### PARTS INCLUDED IN KITS ABOVE

KIT #	Included Parts
30001R	30200R light, 30720 bracket, 94902 plug
30001Y	30200Y light, 30720 bracket, 94902 plug
30504R	30200R light, 30701 grommet, 30722 bracket, 94902 plug
30504Y	30200Y light, 30701 grommet, 30722 bracket, 94902 plug

## 30<sup>®</sup> SERIES, INCANDESCENT, FLANGE MOUNT

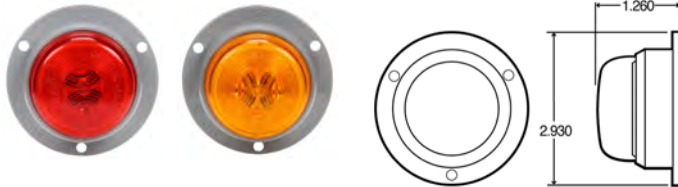

- Innovative design allows one lamp the ability to function as two
- 12 volt, 15,000-hour-rated bulb
- Lamp designed for PC requirements on a 45-degree angle in grommet mounting devices #30700, #30702, #30704, #30706 and #30707

Part Number	Lens Color	Mount Color	Lamp Connector	Volts	Amps	Bulbs	Lighting Codes	Warranty
30222R	Red	Gray	PL-10	12	0.33	1	P2 PC	1-year
30222Y	Yellow	Gray	PL-10	12	0.33	1	P2 PC	1-year
30223R	Red	Gray	PL-10	12	0.33	1	P2 P3 PC	1-year
30223Y	Yellow	Gray	PL-10	12	0.33	1	P2 P3 PC	1-year

### 30<sup>®</sup> SERIES, INCANDESCENT, FLUSH MOUNT

- Flanges are permanently affixed to lamp
- 12 volt, 15,000-hour-rated bulb
- Flush mount is not suitable for PC requirements

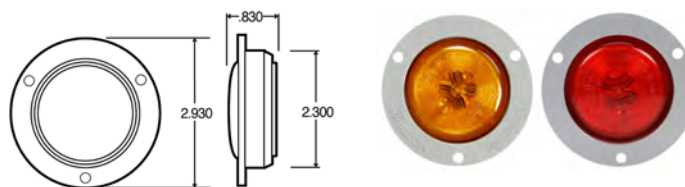

Part Number	Lens Color	Mount Color	Lamp Connector	Volts	Amps	Bulbs	Lighting Codes	Warranty
30221R	Red	Gray	PL-10	12	0.33	1	P2	1-year
30221Y	Yellow	Gray	PL-10	12	0.33	1	P2	1-year

INCANDESCENT

30 SERIES

### 30<sup>®</sup> SERIES, INCANDESCENT, GROMMET MOUNT, BEEHIVE

- Features a beehive lens designed for cab marker use
- Lens and housing are sonically sealed
- High impact polycarbonate construction
- 12, volt 15,000-hour-rated bulb
- Suitable for PC requirements on a 45 angle

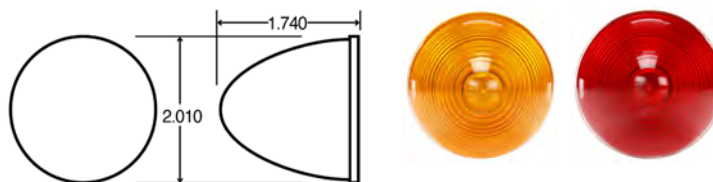

Part Number	Lens Color	Lamp Connector	Volts	Amps	Bulbs	Lighting Codes	Warranty
30201R	Red	PL-10	12	0.33	1	P2 PC	LIFETIME
30201Y	Yellow	PL-10	12	0.33	1	P2 PC	LIFETIME

INCANDESCENT

30 SERIES

### 60<sup>®</sup> SERIES, INCANDESCENT, GROMMET MOUNT, REFLECTORIZED

- Features a beehive lens designed for cab marker use
- Lens and housing are sonically sealed
- High-impact polycarbonate construction
- 12 volt, 15,000-hour-rated bulb
- Suitable for PC requirements on a 45-angle

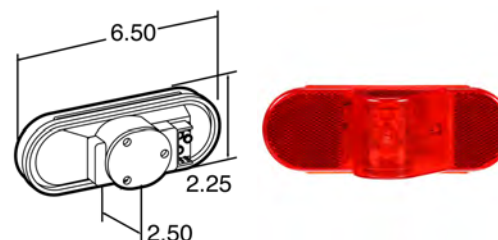

Part Number	Lens Color	Lamp Connector	Volts	Amps	Bulbs	Lighting Codes	Warranty
60215R	Red	PL-3	12	0.49/2.1	1	A P2	1-year

INCANDESCENT

60 SERIES

# IDENTIFICATION BARS

## LED LIGHTS

Pages 166-168

SERIES	PAGES
15® Series	166
33® Series	166
35® Series	167-168

## INCANDESCENT LIGHTS

Pages 169-171

SERIES	PAGES
10® Series	169
15® Series	169
26 Series	170
30® Series	170
Signal-Stat	171

# 15<sup>®</sup> SERIES, LED, ID LIGHT ASSEMBLY, GROMMET MOUNT, KIT



RED



YELLOW

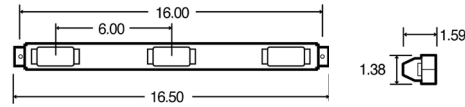

- Designed to fit applications requiring minimal space
- Features stainless steel bar with three LED Model 15 lamps on 6" centers
- Electronics completely sealed in epoxy to resist corrosion and moisture
- Sonically sealed lens and housing
- Less susceptible to shock and vibration
- Draws less current, allowing more power for other vehicle requirements
- Direct pin-to-circuit board solders assure vibration-resistant contacts

Standards Met

P2



Part Number	Lens Color	Lamp Connector	Plug Side 1	Plug Side 2	Volts	Diodes	Mount Color	Center Distance	Kit Includes
15050R	Red	PL-10	PL-10	.180 Bullet/Ring Terminal	12	1	Silver	6in	15250R light, 00808 bar, 93943 harness
15050Y	Yellow	PL-10	PL-10	.180 Bullet/Ring Terminal	12	3	Silver	6in	15250Y light, 00808 bar, 93943 harness

# 33<sup>®</sup> SERIES, LED, ID LIGHT ASSEMBLY, GROMMET MOUNT

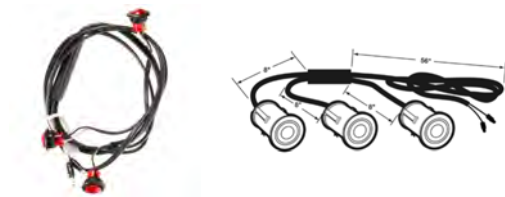

- US patent #6612728
- World smallest LED marker lamp for the transportation industry
- Hardwired lamp design is easily retrofitted
- Requires 3/4" mounting hole



Standards Met

P2

Part Number	Lens Color	Lamp Connector	Plug Side 1	Plug Side 2	Volts	Amps Major/Minor	Diodes	Mount Color
33740R	Red	Hardwired	Hardwired	.180 Bullet	12	0.05	1	Black
33751R	Red	Hardwired	Hardwired	.180 Bullet/Female .180 Bullet	12	0.05	1	Black

## Keep Your Connections Safe. Don't Forget Your Dielectric Gel.

Dielectric gel protects your lights by protecting the points of contact between elements of your lighting and harness system. Our dielectric compounds prevent arcing and corrosion and keep your lights performing as they should.

You can find our dielectric products on page 498





## 35<sup>®</sup> SERIES, LED, ID LIGHT ASSEMBLY, GROMMET MOUNT, KIT

## Standards Met

P2|P3

- Designed to fit applications requiring minimal space
- Slim 1" width is perfect for upper rail mounting
- Draws less current, allowing more power for other vehicle requirements

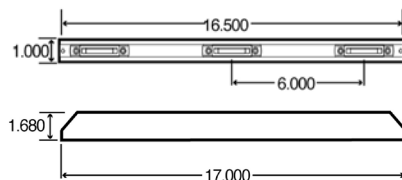

15050R



15050Y

Part Number	Lens Color	Lamp Connector	Plug Side 1	Plug Side 2	Volts	Diodes	Mount Color	Center Distance	Kit Includes
35740R	Red	Fit 'N Forget M/C	Fit 'N Forget M/C	.180 Bullet/Ring Terminal	12	1	Silver	6in	35200R light, 00815 bar, 96989 harness
35740Y	Yellow	Fit 'N Forget M/C	Fit 'N Forget M/C	.180 Bullet/Ring Terminal	12	3	Silver	6in	35200Y light, 00815 bar, 96989 harness
35741R	Red	Fit 'N Forget M/C	Fit 'N Forget M/C	.180 Bullet/Ring Terminal	12	1	Silver	9in	35200R light, 00816 bar, 96996 harness
35741Y	Yellow	Fit 'N Forget M/C	Fit 'N Forget M/C	.180 Bullet/Ring Terminal	12	3	Silver	9in	35200Y light, 00816 bar, 96996 harness

## 35<sup>®</sup> SERIES, LED, DUAL FUNCTION, ID LIGHT ASSEMBLY, BRACKET MOUNT, 3 LIGHTS, KIT

## Standards Met

P2|PC



- Allows marker and clearance lamps to operate in two output levels
- Brighter lighting activated by the brake function
- Great for retrofitting existing lighting systems
- Provides added safety benefit to trailing drivers with additional braking awareness at a higher level on the vehicle notifying drivers more quickly of vehicle stops
- Internal electronics protect vehicle from electrical feedback
- Heavy-duty design allows for carefree maintenance

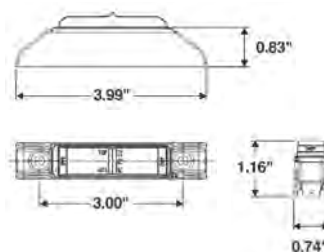

Part Number	Lens Color	Lamp Connector	Plug Side 1	Plug Side 2	Volts	Diodes	Mount Color	Kit Includes
35033R	Red	Fit 'N Forget M/C	No Plug	No Plug	12	5	Red	35200R light, 00815 bar, 96989 harness
35035R	Red	Fit 'N Forget M/C	No Plug	No Plug	12	5	Red	35200R light, 00816 bar, 96996 harness

# 35<sup>®</sup> SERIES, LED, DUAL FUNCTION, ID LIGHT ASSEMBLY, BRACKET MOUNT, KIT, 5 LIGHTS

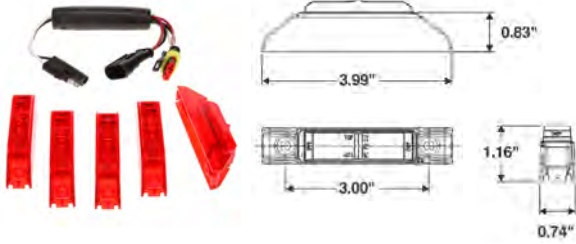

- Allows marker and clearance lamps to operate in two output levels
- Brighter lighting activated by the brake function
- Great for retrofitting existing lighting systems
- Provides added safety benefit to trailing drivers with additional braking awareness at a higher level on the vehicle notifying drivers more quickly of vehicle stops
- Internal electronics protect vehicle from electrical feedback
- Heavy-duty design allows for carefree maintenance

Standards Met

P2|PC



Part Number	Lens Color	Lamp Connector	Plug Side 1	Plug Side 2	Volts	Diodes	Mount Color	Kit Includes
35034R	Red	Fit 'N Forget M/C	No Plug	No Plug	12	5	Red	35200Y light, 00815 bar, 96989 harness
35036R	Red	Fit 'N Forget M/C	No Plug	No Plug	12	5	Red	35200Y light, 00816 bar, 96996 harness



## Quick Tip: Plug Side 1 vs. Plug Side 2

When buying a plug for your light it's important to understand what type of connection mates with the light and what type of termination will mate with the power harness. Plug Side 1 refers to the side of the plug that mates directly to the light. Plug Side 2 refers to the end of the plug that will mate with the power source.



## Keep Your Connections Safe. Don't Forget Your Dielectric Gel.

Dielectric gel protects your lights by protecting the points of contact between elements of your lighting and harness system. Our dielectric compounds prevent arcing and corrosion and keep your lights performing as they should.

You can find our dielectric products on page 498



# 10<sup>®</sup> SERIES, INCANDESCENT, 4 SCREW BRACKET MOUNT, KIT

Standards Met

P2

- Features rugged stainless steel or black enameled ID bar
- Lamps are mounted on 6" or 9" centers

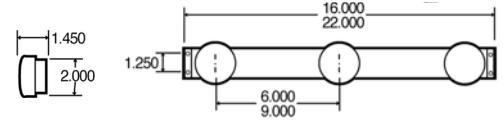

Part Number	Lens Color	Lamp Connector	Plug Side 1	Plug Side 2	Volts	Bulbs	Mount Color	Center Distance	Kit Includes
10744R	Red	PL-10	PL-10	Stripped End/Ring Terminal	12	1	Black	6in	35200R light, 00815 bar, 96989 harness
10745R	Red	PL-10	PL-10	Stripped End/Ring Terminal	12	1	Black	9in	10202R light, 00798 bar, 93906 harness

# 15<sup>®</sup> SERIES, INCANDESCENT, 4 SCREW BRACKET MOUNT, KIT

Standards Met

P2

- Features rugged stainless steel ID bar designed to fit in limited mounting areas
- Lamps are mounted on 6" centers
- Direct replacement for Ford
- Fits in most narrow header rails
- Snap-lock tabs allow easy installation



RED



YELLOW

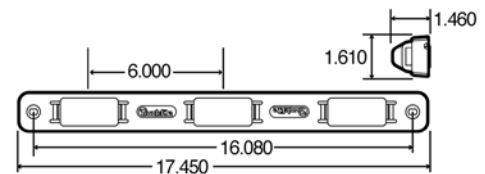

Part Number	Lens Color	Lamp Connector	Plug Side 1	Plug Side 2	Volts	Bulbs	Mount Color	Center Distance	Kit Includes
15741R	Red	PL-10	PL-10	.180 Bullet/Ring Terminal	12	1	Silver	6in	15200R light, 00808 bar, 93943 harness
15745R	Red	PL-10	PL-10	Stripped End	12	1	Black	6in	10202R light, 00798 bar, 93906 harness
15745Y	Yellow	PL-10	PL-10	Stripped End	12	1	Black	6in	15200Y light, 00817 bar, 93945 harness

INCANDESCENT

10 SERIES

INCANDESCENT

15 SERIES

## 26 SERIES, INCANDESCENT, 4 SCREW BRACKET MOUNT, KIT, BEEHIVE

INCANDESCENT

26 SERIES



- Features zinc-plated steel bar in either 15" or 20" lengths
- Bar contains three lamps with #67 bulb and lens retention snap ring

Standards Met
P2

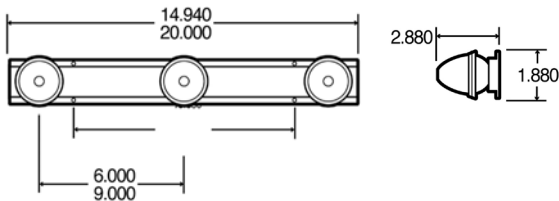

Part Number	Lens Color	Lamp Connector	Plug Side 1	Plug Side 2	Volts	Bulbs	Mount Color	Center Distance	Kit Includes
26740R	Red	Hardwired	Hardwired	Stripped End	12	1	Silver	9in	9004 light, 97947 snap ring
26741R	Red	Hardwired	Hardwired	Stripped End	12	1	Silver	6in	9004 light, 97947 snap ring

## 30<sup>®</sup> SERIES, INCANDESCENT, 4 SCREW BRACKET MOUNT, KIT

INCANDESCENT

30 SERIES



- Features rugged stainless steel or black enameled ID bar
- Lamps are mounted on 6" or 9" centers

Standards Met
P2

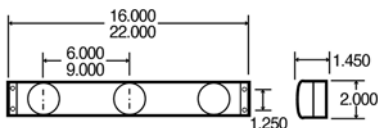

Part Number	Lens Color	Lamp Connector	Plug Side 1	Plug Side 2	Volts	Bulbs	Mount Color	Center Distance	Kit Includes
30740R	Red	PL-10	PL-10	Stripped End/Ring Terminal	12	1	Black	6in	30200R light, 00798 bar, 93906 harness
30742R	Red	PL-10	PL-10	Stripped End/Ring Terminal	12	1	Black	9in	35200Y light, 00816 bar, 96996 harness

# SIGNAL-STAT, INCANDESCENT, 1" X 2", 2 SCREW BRACKET MOUNT, KIT



Standards Met

P2

- Popular economy identification bar for light duty applications
- Acrylic lens and housing
- Coated polycarbonate bar

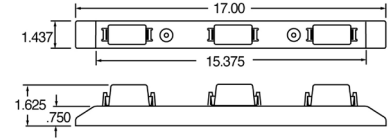

Part Number	Lens Color	Lamp Connector	Plug Side 1	Plug Side 2	Volts	Bulbs	Mount Color	Kit Includes
1508R	Red	Hardwired	Hardwired	Stripped End/ Ring Terminal	12	1	White	35200R light, 00815 bar 96989 harness

INCANDESCENT

SIGNAL-STAT

# SIGNAL-STAT, INCANDESCENT, 2" X 4", BRACKET MOUNT, KIT



Standards Met

P2|PC

- Popular economy identification bar for light duty applications
- Acrylic lens and housing
- Coated polycarbonate bar



RED



AMBER

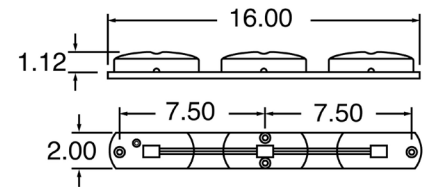

Part Number	Lens Color	Lamp Connector	Plug Side 1	Plug Side 2	Volts	Bulbs	Mount Color	Kit Includes
1215	Red	Hardwired	Hardwired	Stripped End	12	2	Black	35200R light, 00815 bar 96989 harness
1216	Red	Hardwired	Hardwired	Stripped End	12	2	White	35200R light, 00815 bar 96989 harness
1216A	Amber	Hardwired	Hardwired	Stripped End	12	2	White	35200R light, 00815 bar 96989 harness

INCANDESCENT

SIGNAL-STAT

# PERSONAL TRAILER KITS

## LED TRAILER KITS

Page 174

SERIES	PAGES
Signal-Stat Square	174

## INCANDESCENT TRAILER KITS

Pages 175-176

SERIES	PAGES
Signal-Stat Rectangular	175-176

# SIGNAL-STAT, LED, SQUARE, LH S/T/T & RH S/T/T, KIT

LED

SQUARE

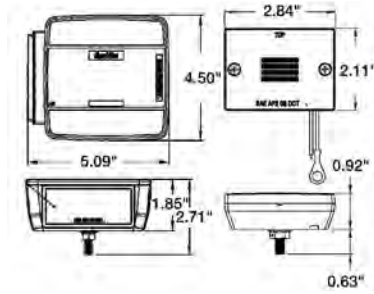

Functions Include  
Left Hand S/T/T, Right Hand S/T/T

- Popular on camping, motorcycle, horse and utility trailers
- Kit provides all legal lamps and reflective products for trailer less than 80 inches wide
- Roadside lamp includes license plate lamp
- Solid-state LED lamps offer greater resistance from damage due to vibration
- Rugged plastic design prevents corrosion
- 12 diode stop, turn and tail lamp with 1 diode side marker lamp, 1 diode marker clearance lamp

Part Number	Position	Mount Type	Lamp Connection	Plug Side 1	Plug Side 2	Volts	Amps Major/Minor	Replacement Parts
5050DK	RH/LH	Bracket	Hardwired	Hardwired	Stripped End	12	0.16/0.05	8947 M/C lens, 8948 trailer light lens, 8947A yellow M/C lens

# SIGNAL-STAT, LED, SQUARE, KIT, M/C INCLUDED

LED

SQUARE

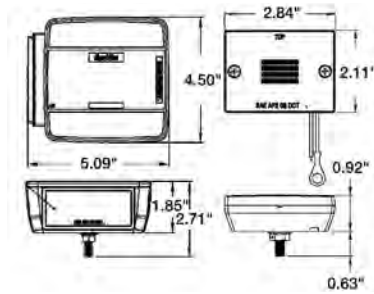

Functions Include  
Left Hand S/T/T, Right Hand S/T/T,  
Left Hand M/C, Right Hand M/C

- Popular on camping, motorcycle, horse and utility trailers
- Kit provides all legal lamps and reflective products for trailer less than 80 inches wide
- Roadside lamp includes license plate lamp
- Solid-state LED lamps offer greater resistance from damage due to vibration
- Rugged plastic design prevents corrosion
- 12 diode stop, turn and tail lamp with 1 diode side marker lamp, 1 diode marker clearance lamp

Part Number	Position	Mount Type	Lamp Connection	Plug Side 1	Plug Side 2	Volts	Amps Major/Minor
5051DK	RH/LH	Bracket	Hardwired	Hardwired	Stripped End	12	0.16/0.05



# SIGNAL-STAT, INCANDESCENT, RECTANGULAR



Part Number	Functions Include
534D	Left Hand S/T/T
535D	Right Hand S/T/T

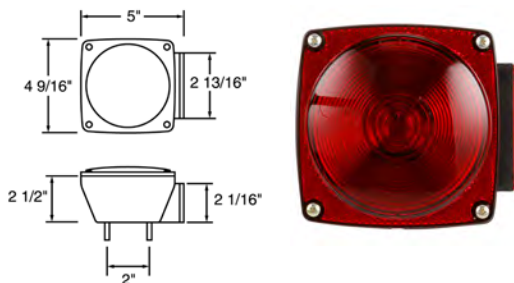

- For use on camping, motorcycle, horse and utility trailers
- Kit provides all legal lamps and reflective products for trailers less than 80" wide
- Special electrical connections eliminate external wiring splices
- Rugged plastic design prevents corrosion
- S/T/T Lamps mount on two studs, at 2" centers
- Upgrade to Truck-Lite LED systems using part #5050DK or 5051DK

Part Number	Position	Mount Type	Lamp Connection	Plug Side 1	Plug Side 2	Volts	Amps Major/Minor	Replacement Parts
534D	LH	Bracket	Hardwired	Hardwired	Stripped End	12	2.1/0.59	1570 light, 1570A light, 8947 lens, 8948 lens, 8947A lens
535D	RH	Bracket	Hardwired	Hardwired	Stripped End	12	2.1/0.59	1570 light, 1570A light, 8947 lens, 8948 lens, 8947A lens

INCANDESCENT

SQUARE

# SIGNAL-STAT, INCANDESCENT, RECTANGULAR, KIT



Functions Include
Left Hand S/T/T, Right Hand S/T/T, Left Hand M/C, Right Hand M/C

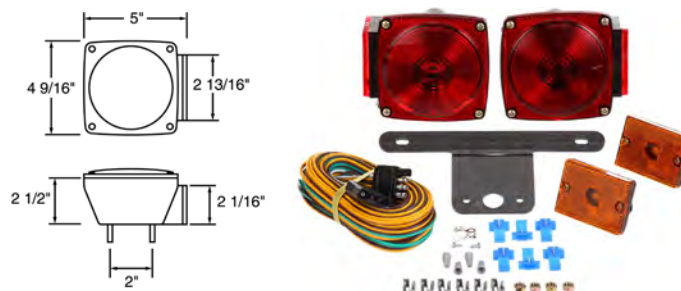

- For use on camping, motorcycle, horse and utility trailers
- Kit provides all legal lamps and reflective products for trailers LESS than 80" wide
- Special electrical connections eliminate external wiring splices
- Front side marker lamps include built-in reflectors
- Rugged plastic design prevents corrosion
- Kit includes two lamps, 20' four-wire split Y-harness, a flexible license bracket, two S/T/T lamps, two side marker lamps, frame clips, wire nuts and easy to read instructions
- S/T/T lamps mount on two studs at 2" centers
- Upgrade to Truck-Lite LED systems using part #5050DK or 5051DK

Part Number	Position	Mount Type	Lamp Connection	Plug Side 1	Plug Side 2	Volts	Amps Major/Minor	Replacement Parts
533DK	RH/LH	Bracket	Hardwired	Hardwired	Stripped End	12	2.1/0.59	1570 light, 1570A light

INCANDESCENT

SQUARE

## TRUCK-LITE, INCANDESCENT, RECTANGULAR, KIT



- Popular on boat trailers under 80" wide
- Kits without side marker lamps are intended for trailers under 6' long



Part Number	Functions Include
55554	Left Hand S/T/T, Right Hand S/T/T
55554-1	Left Hand S/T/T, Right Hand S/T/T

Part Number	Position	Mount Type	Lamp Connection	Plug Side 1	Plug Side 2	Volts	Amps Major/Minor	Replacement Parts	Package Type
55554	RH/LH	Bracket	Hardwired	Hardwired	Stripped End	12	2.1/0.59	99127R lens, 80722 bracket mount, 99126R lens	
55554-1	RH/LH	Bracket	Hardwired	Hardwired	Stripped End	12	2.1/0.59	99127R lens, 80722 bracket mount, 99126R lens	Display

## SIGNAL-STAT, INCANDESCENT, RECTANGULAR

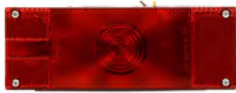

Part Number	Functions Include
528	Left Hand S/T/T
529	Right Hand S/T/T



Part Number	Position	Mount Type	Lamp Connection	Plug Side 1	Plug Side 2	Volts	Amps Major/Minor
528	LH	Bracket	Hardwired	Hardwired	Stripped End/Ring Terminal	12	0.33
529	RH	Bracket	Hardwired	Hardwired	Stripped End/Ring Terminal	12	0.33

## SIGNAL-STAT, INCANDESCENT, RECTANGULAR, KIT



- Deluxe kit features a sealed lamp capsule that protects the bulb and electrical contacts from damage by water and corrosion
- Left hand lamp includes license plate illuminator
- S/T/T lamp 8L x 2-7/8H x 2-3/4D



Functions Include
Left Hand S/T/T, Right Hand S/T/T, Left Hand M/C, Right Hand M/C

Part Number	Position	Mount Type	Lamp Connection	Plug Side 1	Plug Side 2	Volts	Amps Major/Minor	Replacement Parts
530DK	RH/LH	Bracket	Hardwired	Hardwired	Stripped End/Ring Terminal	12	2.1/0.59	528 light, 529 light, 9676 lens

# Looking for even more product information?

Visit [truck-lite.com](http://truck-lite.com)



**Powerful Search  
Function**



**360° Product  
Images**



**Easy-To-Find  
Replacement  
Parts**

# LICENSE & BACK-UP LIGHTS

## LICENSE LIGHTS

Pages 182-190

### LED

SERIES	COMMON SIZE	PAGES
15® Series	1" x 2"	182
33® Series	0.75"	183
36 Series	1" x 2"	184

### INCANDESCENT

SERIES	COMMON SIZE	PAGES
15® Series	1" x 2"	185
17 Series	2"	185-186
19® Series	2"	186
21® Series	2" x 6"	187
Super 21®	2" x 6"	187-188
26 Series	1"	188-189
Signal-Stat	Multiple	190

**LED**

<b>SERIES</b>	<b>COMMON SIZE</b>	<b>PAGES</b>
<b>Super 44®</b>	4"	191-195
<b>Signal-Stat</b>	4"	195-196
<b>66 Series</b>	2" x 6"	196
<b>Signal-Stat Oval</b>	2" x 6"	197
<b>Signal-Stat Rectangular</b>	3" x 5"	197

**INCANDESCENT**

<b>SERIES</b>	<b>COMMON SIZE</b>	<b>PAGES</b>
<b>40® Series</b>	4"	198-199
<b>Super 40®</b>	4"	200
<b>45® Series</b>	3" x 5"	201
<b>Super 45®</b>	3" x 5"	201
<b>60® Series</b>	2" x 6"	202
<b>60® Economy</b>	2" x 6"	203
<b>80 Series</b>	4"	203-204
<b>1 Bulb 4in</b>	4"	204-205
<b>Signal-Stat 1 Bulb 4in</b>	4"	205
<b>1 Bulb 2in x 6in</b>	2" x 6"	206
<b>1 Bulb 4in x 6in</b>	4" x 6"	206







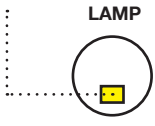
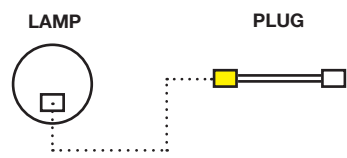
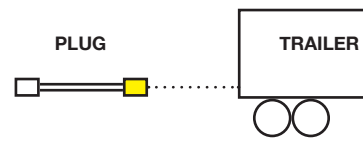





# License & Back-Up Lights

Introduced originally by Truck-Lite, these bright, dependable LED back-up and license lighting and space-saving combination lamps come in a variety of shapes and sizes.

<p><b>Shapes</b></p>	<p>Round, Oval, Rectangular</p>
<p><b>Mount Types</b></p>	<p>Grommet, Flange, 2 Screw, 4 Screw, Adhesive</p>
<p><b>Connection Information</b></p> <p>When it comes to choosing the correct lamps for your truck or trailer, it's important to know the connection type on your vehicle's harness.</p> <p>If the harness connector type does not match your desired light (lamp connector), you will need a plug to complete the connection.</p>	<p><b>Lamp Connector</b></p> <p>The connector type located on the back of a lamp</p>  <p><b>Plug Side 1</b></p> <p>The connection between a plug and a lamp</p>  <p><b>Plug Side 2</b></p> <p>The connection between a plug and a trailer's harness</p> 

(800) 562-5012 | [truck-lite.com](http://truck-lite.com)

 <p><b>Manufacturing &amp; Quality</b></p>	 <p><b>Testing &amp; Safety</b></p>
<p>Truck-Lite’s LED license and back-up lighting is built using premium materials and backed by industry-leading warranties.</p> <p>Designed to last the life of your vehicle, Truck-Lite’s solid-state construction and sealed circuitry mean that you can depend on your lighting to withstand shock, vibration, moisture and debris.</p>	<p>All Truck-Lite lamps are subjected to rigorous environmental, electrical and mechanical testing before they are validated and released to the market.</p> <p>All lamps comply with FMVSS/CMVSS-108, SAE and DOT standards when properly mounted.</p>
 <p><b>Performance &amp; Maintenance</b></p>	 <p><b>Customer Support</b></p>
<ul style="list-style-type: none"> <li>• Lower energy consumption</li> <li>• Impact-resistant, non-yellowing lenses and rugged housing protect against damage from even the toughest applications</li> <li>• Robust, cost-effective design</li> </ul>	<p><b>Customer Service</b></p> <p> (800) 562-5012 customerservice@truck-lite.com</p> <p><b>Technical Support</b></p> <p> (888) 562-5012 tltech@truck-lite.com</p> <p><b>License/BU Light Warranties</b></p> <div style="display: flex; justify-content: space-around; align-items: center;">      </div>
<p>(800) 562-5012   truck-lite.com</p>	

## 15<sup>®</sup> SERIES, LED, 3 DIODE, 1"x2", BRACKET MOUNT

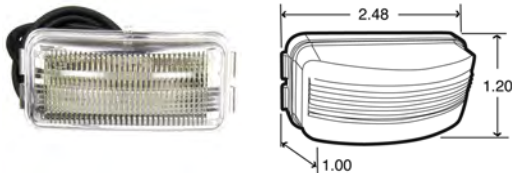

- Meets SAE J587 and European ECE Regulations 4
- Hardwired design with adapter plug for quick changeover without rewiring
- Functions as utility lamp or license lamp when properly mounted using license plate brackets #00820, #15729, #15730, #15732 or #15736

Part Number	Lamp Connector	Plug Side 1	Plug Side 2	Lens Color	Lens Material	Volts	Amps
15905	Hardwired	Hardwired	Stripped End	Clear	PC	24	0.03
15205	Hardwired	Hardwired	Female PL-10	Clear	PC	12	0.03
15226	Hardwired	Hardwired	Female PL-10	Clear	PC	12	0.03
15227	Hardwired	Hardwired	.180 Bullet	Clear	PC	12	0.03

## 15<sup>®</sup> SERIES, LED, 3 DIODE, 1"x2", BRACKET MOUNT, KIT

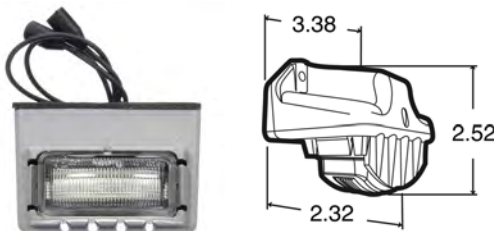

- Meets SAE J587 and European ECE Regulations 4
- Hardwired design w/ adapter plug for quick changeover without rewiring
- Functions as utility lamp or license lamp when properly mounted using license plate brackets #00820, #15729, #15730, #15732 or #15736

Part Number	Lamp Connector	Plug Side 1	Plug Side 2	Lens Color	Lens Material	Mount Color	Volts	Amps	Kit Includes
15040	Hardwired	Hardwired	Female PL-10	Clear	PC	Gray	12	0.03	15205 light, 15729 bracket mount, 97032 gasket
15041	Hardwired	Hardwired	Female PL-10	Clear	PC	Black	12	0.03	15205 light, 15730 bracket mount, 97032 gasket
15042	Hardwired	Hardwired	Stripped End	Clear	PC	Gray	24	0.03	15905 light, 15729 bracket mount, 97032 gasket
15043	Hardwired	Hardwired	Stripped End	Clear	PC	Black	24	0.03	15905 light, 15730 bracket mount, 97032 gasket
15053	Hardwired	Hardwired	Female PL-10	Clear	AC	Gray	12	0.03	15226 light, 15729 bracket mount, 97032 gasket
15054	Hardwired	Hardwired	.180 Bullet	Clear	PC	Gray	12	0.03	15227 light, 15729 bracket mount, 97032 gasket
15055	Hardwired	Hardwired	Female PL-10	Clear	PC	Chrome	12	0.03	15205 light, 15732 bracket mount, 97032 gasket
15056	Hardwired	Hardwired	Stripped End	Clear	PC	Chrome	24	0.03	15905 light, 15732 bracket mount, 97032 gasket
15058	Hardwired	Hardwired	.180 Bullet	Clear	PC	Black	12	0.03	15227 light, 15730 bracket mount, 97032 gasket
15059	Hardwired	Hardwired	Female PL-10	Clear	PC	Chrome	12	0.03	15226 light, 15732 bracket mount, 97032 gasket
15060	Hardwired	Hardwired	.180 Bullet	Clear	PC	Chrome	12	0.03	15227 light, 15732 bracket mount, 97032 gasket
15061	Hardwired	Hardwired	Female PL-10	Clear	PC	Black	12	0.03	15226 light, 15730 bracket mount, 97032 gasket



## 33<sup>®</sup> SERIES, LED, 1 DIODE, 0.75", GROMMET MOUNT



- Hardwired lamp design is easily retrofitted, with only a 1-3/16" mounting hole required for grommet installation
- US Patent 5,943,798
- Product designed to fit in 33705 grommet
- Top and side plate mounting options
- When mounted into a module, all wires are hidden inside module, protecting against damage from corrosion
- Does not require a bracket, so it can be mounted directly into the vehicle
- Stealth, low-profile design is resistant to damage, and hides lamp away from view to help prevent theft
- LEDs draw less current, allowing more power for other vehicle requirements
- Reduces lighting costs due to physical damage and heat entrapment
- Electronics are completely sealed in epoxy to resist corrosion and moisture

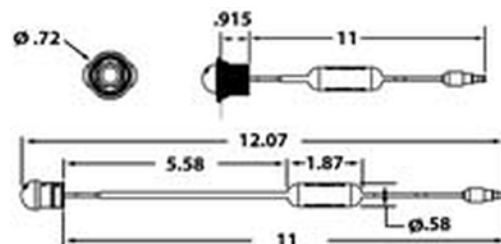

Part Number	Lamp Connector	Plug Side 1	Plug Side 2	Lens Color	Lens Material	Mount Color	Volts	Amps
33210C	Hardwired	Hardwired	.180 Bullet	Clear	PC		12	0.15

## 33<sup>®</sup> SERIES, LED, 1 DIODE, 0.75", GROMMET MOUNT, KIT



- Hardwired lamp design is easily retrofitted, with only a 1-3/16" mounting hole required for grommet installation
- US Patent 5,943,798
- Product designed to fit in 33705 grommet
- Top and side plate mounting options
- When mounted into a module, all wires are hidden inside module, protecting against damage from corrosion
- Does not require a bracket, so it can be mounted directly into the vehicle
- Stealth, low-profile design is resistant to damage, and hides lamp away from view to help prevent theft
- LEDs draw less current, allowing more power for other vehicle requirements
- Reduces lighting costs due to physical damage and heat entrapment
- Electronics are completely sealed in epoxy to resist corrosion and moisture

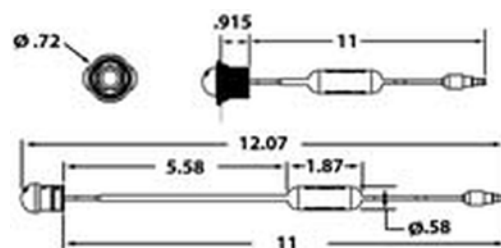

Part Number	Lamp Connector	Plug Side 1	Plug Side 2	Lens Color	Lens Material	Mount Color	Volts	Amps	Kit Includes
33010C	Hardwired	Hardwired	.180 Bullet	Clear	PC	Black	12	0.15	33210C light, 33705 grommet

LED  
36 SERIES

### 36 SERIES, LED, 3 DIODE, 1"X2", ADHESIVE MOUNT

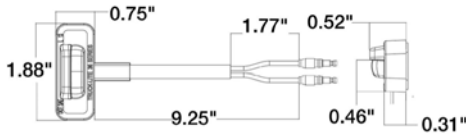

- Provides license lamp solution that requires no mounting brackets or installation screws
- Lamp adheres directly to mounting surface through use of heavy-duty adhesive backing, with an easy-to-install, peel-off liner
- OmniVolt
- Hardwired with rear and side exit wires complete with .180 molded bullets
- Can be mounted without any mounting brackets or fasteners
- LEDs draw much less current and are rated at 100,000 hours
- Electronics are completely sealed in epoxy to resist damage caused by moisture, corrosion, shock and vibration
- When properly mounted the lamps are designed to conform to the applicable requirements of FMVSS - 108



Part Number	Lamp Connector	Plug Side 1	Plug Side 2	Lens Color	Lens Material	Mount Color	Volts	Amps
36145C	Hardwired	Hardwired	.180 Bullet	Clear	PC	Black	12 24	0.05
36140C	Hardwired	Hardwired	.180 Bullet	Clear	PC	Black	12 24	0.05

LED  
36 SERIES

### 36 SERIES, LED, 3 DIODE, 1"X2", ADHESIVE MOUNT, KIT

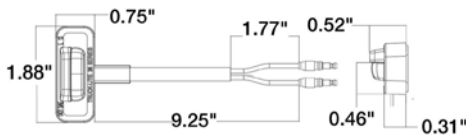

- Provides license lamp solution that requires no mounting brackets or installation screws
- Lamp adheres directly to mounting surface through use of heavy-duty adhesive backing, with an easy-to-install, peel-off liner
- OmniVolt
- Hardwired with rear and side exit wires complete with .180 molded bullets
- Can be mounted without any mounting brackets or fasteners
- LEDs draw much less current and are rated at 100,000 hours
- Electronics are completely sealed in epoxy to resist damage caused by moisture, corrosion, shock and vibration
- When properly mounted the lamps are designed to conform to the applicable requirements of FMVSS - 108



Part Number	Lamp Connector	Plug Side 1	Plug Side 2	Lens Color	Lens Material	Mount Color	Volts	Amps	Kit Includes
36041C	Hardwired	Hardwired	.180 Bullet	Clear	PC	Gray	12 24	0.05	36140C light, 36710 bracket
36042C	Hardwired	Hardwired	.180 Bullet	Clear	PC	Black	12 24	0.05	36140C light, 36711 bracket

## 15<sup>®</sup> SERIES, INCANDESCENT, 1 BULB, 1"x2", BRACKET MOUNT

- High-impact polycarbonate, sonically sealed lens and housing
- Available in 12 or 24-volt versions
- Features 15,000-hour-long life 12v bulb
- Must be used with Model 15 mounting brackets
- Replaces Signal-Stat 1502W
- Upgrade to LED lighting systems using Truck-Lite's 15 Series LED license lamps

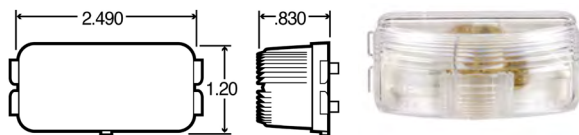

Part Number	Lamp Connector	Lens Color	Lens Material	Volts	Amps
15208	PL-10	Clear	PC	12	0.33
15209	PL-10	Clear	PC	24	0.17

INCANDESCENT

15 SERIES

## 15<sup>®</sup> SERIES, INCANDESCENT, 1 BULB, 1"x2", BRACKET MOUNT, KIT



- Features snap-fit mount for quick installation and easy replacement
- Bracket may be surface mounted

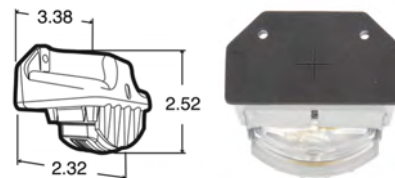

Part Number	Lamp Connector	Lens Color	Lens Material	Mount Color	Volts	Amps	Kit Includes
15011	PL-10	Clear	PC	Gray	12	0.33	15208 light, 15729 bracket, 97032 grommet
15012	PL-10	Clear	PC	Black	12	0.33	15208 light, 15730 bracket, 97032 grommet
15013	PL-10	Clear	PC	Chrome	12	0.33	15208 light, 15732 bracket, 97032 grommet

INCANDESCENT

15 SERIES

## 17 SERIES, INCANDESCENT, 1 BULB, 2", 2 SCREW



- High-impact polycarbonate, sonically sealed lens and housing
- Designed to mount with bracket, #17720
- Horizontal mount only

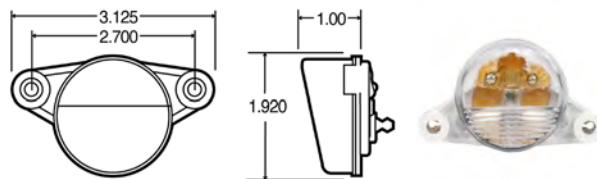

Part Number	Lamp Connector	Lens Color	Lens Material	Mount Color	Volts	Amps
17200	License Lamp Plug	Clear	PC	Gray	12	0.33

INCANDESCENT

17 SERIES

## 17 SERIES, INCANDESCENT, 1 BULB, 2", 2 SCREW, KIT

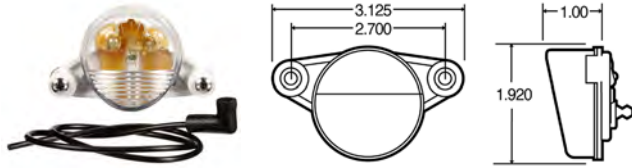

- High-impact polycarbonate, sonically sealed lens and housing
- Designed to mount with bracket, #17720
- Horizontal mount only



Part Number	Lamp Connector	Plug Side 1	Plug Side 2	Lens Color	Lens Material	Mount Color	Volts	Amps	Kit Includes
17001	License Lamp Plug	Right Angle License Lamp Plug	Blunt Cut	Clear	PC	White	12	0.33	17200 light, 94922 plug
17002	License Lamp Plug	Straight License Lamp Plug	Blunt Cut	Clear	PC	White	12	0.33	17200 light, 94923 plug

## 17 SERIES, INCANDESCENT, 1 BULB, 2", BRACKET MOUNT, KIT

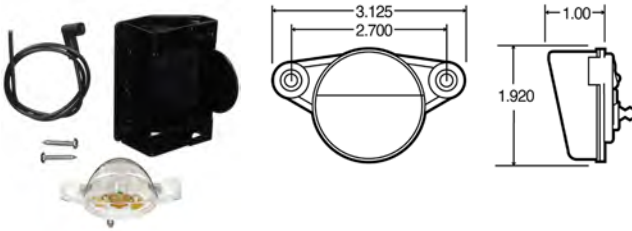

- High-impact polycarbonate, sonically sealed lens and housing
- Designed to mount with bracket, #17720
- Horizontal mount only



Part Number	Lamp Connector	Plug Side 1	Plug Side 2	Lens Color	Lens Material	Mount Color	Volts	Amps	Kit Includes
17003	License Lamp Plug	Right Angle License Lamp Plug	Blunt Cut	Clear	PC	Black	12	0.33	17200 light, 94922 plug

## 19<sup>®</sup> SERIES, INCANDESCENT, 2 BULB, 2", BRACKET MOUNT, KIT

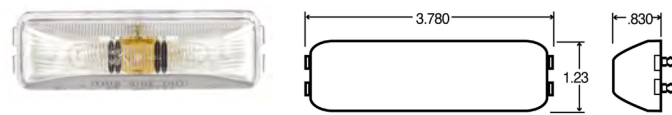

- Fruehauf replacement lamp
- High-impact polycarbonate, sonically sealed lens and housing
- Long-life, 15,000-hour bulbs
- License or utility applications
- Replaces Signal-Stat 1901W



Part Number	Lamp Connector	Lens Color	Lens Material	Volts	Amps
19206	19 Series Male Pin	Clear	PC	12	0.33

INCANDESCENT

17 SERIES

INCANDESCENT

17 SERIES

INCANDESCENT

19 SERIES

## 21<sup>®</sup> SERIES, INCANDESCENT, 2 BULB, 2"x6", 2 SCREW



- Features male pin connections
- Polycarbonate lens and housing withstands impact and corrosion
- Shock mount absorbs road shock and vibration
- Replaces Grote #60331

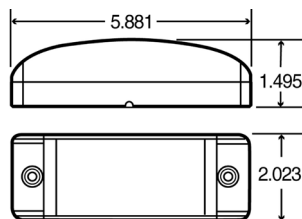

Part Number	Lamp Connector	Lens Color	Lens Material	Mount Color	Volts	Amps
29204C	Male Pin	Clear	PC	Clear	12	0.33

INCANDESCENT

21 SERIES

## 21<sup>®</sup> SERIES, INCANDESCENT, 2 BULB, 2"x6", 2 SCREW, KIT



- Features male pin connections
- Polycarbonate lens and housing withstands impact and corrosion
- Shock mount absorbs road shock and vibration
- Replaces Grote #60331

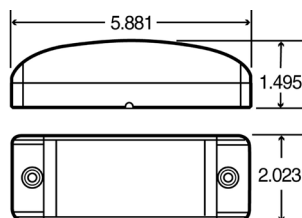

Part Number	Lamp Connector	Plug Side 1	Plug Side 2	Lens Color	Lens Material	Mount Color	Volts	Amps
29004C	Male Pin	Male Pin	.180 Bullet Ring Terminal	Clear	PC	Clear	12	0.33

INCANDESCENT

21 SERIES

## SUPER 21<sup>®</sup>, INCANDESCENT, 1 BULB, 2"x6", 2 SCREW



- Acrylic lens and ABS housing are sonically sealed
- Unique bulb cradle shock mount absorbs shock and vibration, prolonging bulb life
- Long life bulb is rated for 15,000 hours
- Lamp kit includes #96930 hot wire

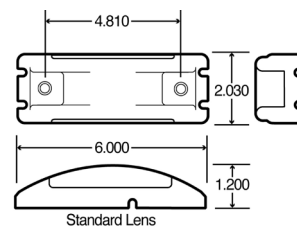

Part Number	Lamp Connector	Lens Color	Lens Material	Mount Color	Volts	Amps
21204C	Super 21 Plug	Clear	AC	Clear	12	0.33

INCANDESCENT

SUPER 21 SERIES

## SUPER 21<sup>®</sup>, INCANDESCENT, 1 BULB, 2"x6", 2 SCREW, KIT

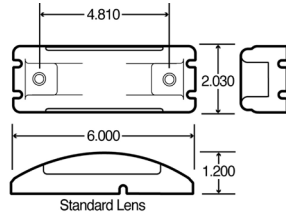

- Acrylic lens and ABS housing are sonically sealed
- Unique bulb cradle shock mount absorbs shock and vibration, prolonging bulb life
- Long-life bulb is rated for 15,000 hours
- Lamp kit includes #96930 hot wire



Part Number	Lamp Connector	Plug Side 1	Plug Side 2	Lens Color	Lens Material	Mount Color	Volts	Amps	Kit Includes
21004C	Super 21 Plug	Super 21 Plug	Stripped End	Clear	AC	Clear	12	0.33	21004C light, 96930 plug

## 26 SERIES, INCANDESCENT, 1 BULB, 1", GROMMET MOUNT, ROUND

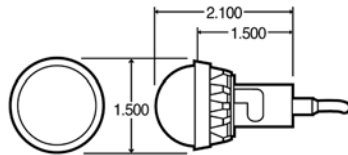

- Features chrome-plated brass housing
- Snap-fit design uses standard 1-1/4" diameter hole
- Commonly used to illuminate a license plate on step bumpers
- Two units required for license illumination
- Ideal for courtesy, map, instrument, license or step lighting
- Snaps securely into any panel thickness up to .187"
- Replaces Signal-Stat 430W



Part Number	Lamp Connector	Plug Side 1	Plug Side 2	Lens Color	Lens Material	Mount Color	Volts	Amps
26331	Hardwired	Hardwired	.180 Bullet	Clear	PC	Chrome	12	0.59

## 26 SERIES, INCANDESCENT, 1 BULB, 1", 2 SCREW, ROUND

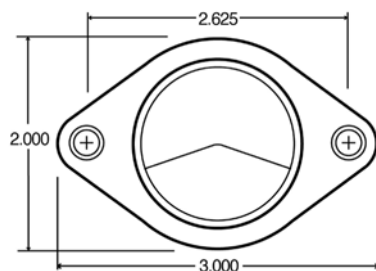

- Features a chrome-plated steel lens shade
- Design is similar to lamps used on GM vehicles
- Two lamps required for license plate illumination
- Rubberized, single-contact electrical plug
- Replaces Signal-Stat 436W



Part Number	Lamp Connector	Plug Side 1	Plug Side 2	Lens Color	Lens Material	Mount Color	Volts	Amps
26336	Hardwired	Hardwired	.156 Bullet	Clear	PC	Chrome	12	0.59

INCANDESCENT

SUPER 21 SERIES

INCANDESCENT

26 SERIES

INCANDESCENT

26 SERIES

## 26 SERIES, INCANDESCENT, 1 BULB, BRACKET MOUNT, KIT



- Features high-impact housing with aerodynamic design
- Mounts on 1-3/4" hole centers
- Replaces Signal-Stat 420W and 423W

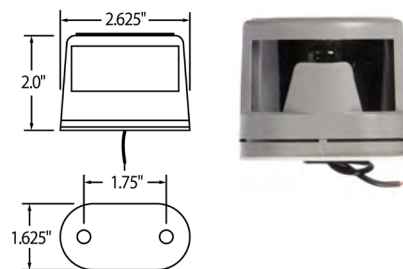

Part Number	Lamp Connector	Plug Side 1	Plug Side 2	Lens Color	Lens Material	Mount Color	Volts	Amps	Kit Includes
26335	Hardwired	Hardwired	Stripped End	Clear	PC	Gray	12	0.59	26380 hood

INCANDESCENT

26 SERIES

## 26 SERIES, INCANDESCENT, 1 BULB, 2 SCREW BRACKET MOUNT



- Extra-rugged cadmium-plated steel housing
- Screw lock cover cams on/off for easy bulb replacement
- Ideal for license, instrument or step lighting
- Surface mounts, grounds through screw
- Replaces Signal-Stat 431W
- 1/4" screw hole diameter

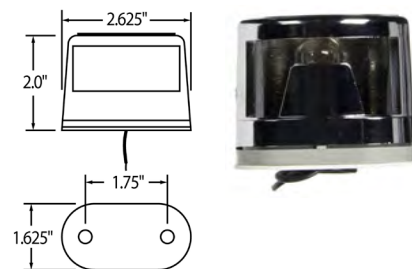

Part Number	Lamp Connector	Plug Side 1	Plug Side 2	Lens Color	Lens Material	Mount Color	Volts	Amps
26330	Hardwired	Hardwired	Stripped End	Clear	PC	Chrome	12	0.59
26371	Hardwired	Hardwired	Stripped End	Clear	PC	Black	12	0.59

INCANDESCENT

26 SERIES

## Keep Your Connections Safe. Don't Forget Your Dielectric Gel.

Dielectric gel protects your lights by protecting the points of contact between elements of your lighting and harness system. Our dielectric compounds prevent arcing and corrosion and keep your lights performing as they should.

You can find our dielectric products on page 498



## SIGNAL-STAT, INCANDESCENT, 1 BULB, 1"X2", BRACKET MOUNT, KIT, RECTANGULAR

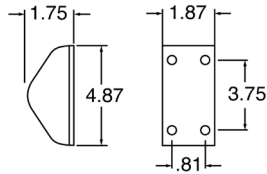

- Aluminum or gray-painted steel housing
- Fully protected lens with high guard
- Pressure pad tightly seals lens
- Quick-click lens removal



Part Number	Lamp Connector	Plug Side 1	Plug Side 2	Lens Color	Lens Material	Mount Color	Volts	Amps
1105W	Hardwired	Hardwired	Stripped End	Clear	PC	Gray	12	0.35

## SIGNAL-STAT, INCANDESCENT, 1 BULB, 2"X6", 2 SCREW BRACKET MOUNT, RECTANGULAR

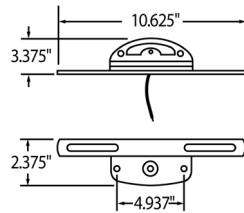

- Original equipment on Airstream
- Chrome-plated steel lamp body
- Rubber pad between lamp and frame



Part Number	Lamp Connector	Plug Side 1	Plug Side 2	Lens Color	Lens Material	Mount Color	Volts	Amps
435W	Hardwired	Hardwired	Stripped End	Clear	AC	Chrome	12	0.59

## SIGNAL-STAT, INCANDESCENT, 1 BULB, 1"X3", 2 SCREW BRACKET MOUNT, TRIANGULAR

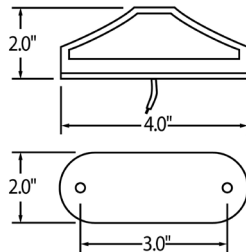
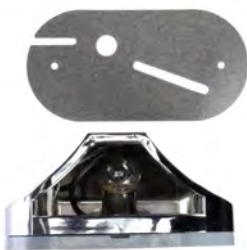

- Snap-grip lens hood for easy bulb replacement
- Ideal for license, instrument or step lighting
- Surface mount, grounds through screw
- Permastat housing will not rust
- Wire length 7 1/2"



Part Number	Lamp Connector	Plug Side 1	Plug Side 2	Lens Color	Lens Material	Mount Color	Volts	Amps
425WD	Hardwired	Hardwired	Stripped End	Clear	PC	Gray	12	0.59
426W	Hardwired	Hardwired	Stripped End	Clear	PC	Chrome	12	0.59



## SUPER 44<sup>®</sup>, LED, 6 DIODE, 4", GROMMET MOUNT



- Features robust, cost-effective, efficient design
- Surpasses back-up specifications with one-lamp, eliminating two-lamp systems
- Resembles Super 44 Series S/T/T lamp diode appearance for consistent look
- Epoxy-encapsulated with exclusive Fit 'N Forget™ plug assembly keeps corrosives away from lamp
- Not recommended for dome lamp use
- U.S. Registered TM #3483147



Part Number	Lamp Connector	Lens Color	Lens Material	Volts	Amps	Diamond Shell
44990C	Fit 'N Forget S.S.	Clear	AC	12	0.53	Yes
44350C	Fit 'N Forget S.S.	Clear	PC	12	0.53	No

LED

SUPER 44

## SUPER 44<sup>®</sup>, LED, 6 DIODE, 4", GROMMET MOUNT, HARDWIRED



- Features robust, cost-effective, efficient design
- Surpasses back-up specifications with 1 lamp, eliminating 2 lamp systems
- Resembles Super 44 Series S/T/T lamp diode appearance for consistent look
- Epoxy-encapsulated with exclusive Fit 'N Forget™ plug assembly keeps corrosives away from lamp
- Not recommended for dome lamp use
- U.S. Registered TM #3483147



Part Number	Lamp Connector	Plug Side 1	Plug Side 2	Lens Color	Lens Material	Volts	Amps
44347C	Hardwired	Hardwired	PL-3	Clear	PC	12	0.53

LED

SUPER 44

## SUPER 44<sup>®</sup>, LED, 6 DIODE, 4", FLANGE MOUNT, KIT



- Features robust, cost-effective, efficient design
- Surpasses back-up specifications with 1 lamp, eliminating 2 lamp systems
- Resembles Super 44 Series S/T/T lamp diode appearance for consistent look
- Epoxy-encapsulated with exclusive Fit 'N Forget™ plug assembly keeps corrosives away from lamp
- Not recommended for dome lamp use
- U.S. Registered TM #3483147

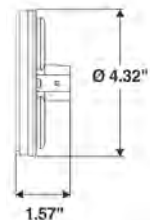

Part Number	Lamp Connector	Plug Side 1	Plug Side 2	Lens Color	Lens Material	Mount Color	Volts	Amps	Kit Includes	Diamond Shell
44180C	Fit 'N Forget S.S.	Fit 'N Forget S.S.	Female PL-2	Clear	PC	Black	12	0.24	44350C light, 40700 grommet 94789 plug	No
44183C	Fit 'N Forget S.S.	Fit 'N Forget S.S.	2 Position Plug	Clear	PC	Black	12	0.24	44350C light, 40700 grommet	No
44184C	Fit 'N Forget S.S.	Fit 'N Forget S.S.	Female PL-2	Clear	AC	Black	12	0.24	44990C light, 40700 grommet 94789 plug	Yes

LED

SUPER 44

LED  
SUPER 44

## SUPER 44®, LED, 6 DIODE, 4" , FLANGE MOUNT



- Features robust, cost-effective, efficient design
- Surpasses back-up specifications with 1 lamp, eliminating 2 lamp systems
- Resembles Super 44 Series S/T/T lamp diode appearance for consistent look
- Epoxy-encapsulated with exclusive Fit 'N Forget™ plug assembly keeps corrosives away from lamp
- Not recommended for dome lamp use
- U.S. Registered TM #3483147



Part Number	Lamp Connector	Lens Color	Lens Material	Mount Color	Volts	Amps	Diamond Shell
44344C	Fit 'N Forget S.S.	Clear	PC	Gray	12	0.53	No
44345C	Fit 'N Forget S.S.	Clear	PC	White	12	0.53	No
44346C	Fit 'N Forget S.S.	Clear	PC	Black	12	0.53	No
44991C	Fit 'N Forget S.S.	Clear	AC	Gray	12	0.53	Yes
44992C	Fit 'N Forget S.S.	Clear	AC	Black	12	0.53	Yes

LED  
SUPER 44

## SUPER 44®, LED, 6 DIODE, 4" , FLANGE MOUNT, HARDWIRED



- Features robust, cost effective, efficient design
- Surpasses back-up specifications with 1 lamp, eliminating 2 lamp systems
- Resembles Super 44 Series S/T/T lamp diode appearance for consistent look
- Epoxy-encapsulated with exclusive Fit 'N Forget™ plug assembly keeps corrosives away from lamp
- Not recommended for dome lamp use
- U.S. Registered TM #3483147



Part Number	Lamp Connector	Plug Side 1	Plug Side 2	Lens Color	Lens Material	Mount Color	Volts	Amps
44348C	Hardwired	Hardwired	Stripped End	Clear	PC	Black	12	0.53
44349C	Hardwired	Hardwired	Stripped End	Clear	PC	White	12	0.53

LED  
SUPER 44

## SUPER 44®, LED, 6 DIODE, 4" , FLANGE MOUNT, KIT



- Features robust, cost-effective, efficient design
- Surpasses back-up specifications with 1 lamp, eliminating 2 lamp systems
- Resembles Super 44 Series S/T/T lamp diode appearance for consistent look
- Epoxy-encapsulated with exclusive Fit 'N Forget™ plug assembly keeps corrosives away from lamp
- Not recommended for dome lamp use
- U.S. Registered TM #3483147



Part Number	Lamp Connector	Plug Side 1	Plug Side 2	Lens Color	Lens Material	Mount Color	Volts	Amps	Kit Includes
44181C	Fit 'N Forget S.S.	Fit 'N Forget S.S.	Female PL-2	Clear	PC	Gray	12	0.24	44344C light, 94789 plug
44182C	Fit 'N Forget S.S.	Fit 'N Forget S.S.	Female PL-2	Clear	PC	Black	12	0.24	44346C light, 94789 plug

## SUPER 44<sup>®</sup>, LED, 27 DIODE, 4", GROMMET MOUNT



- Most advanced and cost-effective 4" LED back-up lamps
- 27-LED pattern lamps require the purchase of two lamps, one for each side

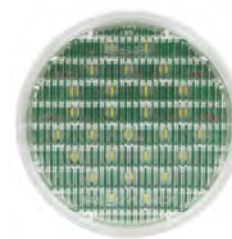

Part Number	Lamp Connector	Lens Color	Lens Material	Mount Color	Volts	Amps
44206C	Fit 'N Forget S.S.	Clear	PC		12	0.1

## SUPER 44<sup>®</sup>, LED, 27 DIODE, 4", GROMMET MOUNT, KIT



- Most advanced and cost-effective 4" LED back-up lamps
- 27-LED pattern lamps require the purchase of two lamps, one for each side
- 54-LED pattern lamps require the purchase of only 1 lamp



Part Number	Lamp Connector	Plug Side 1	Plug Side 2	Lens Color	Lens Material	Mount Color	Volts	Amps	Kit Includes	Diamond Shell
44041C	Fit 'N Forget S.S.	Fit 'N Forget S.S.	Female PL-2	Clear	PC	Black	12	0.1	44206C light, 40700 grommet	No
44141C	Fit 'N Forget S.S.	Fit 'N Forget S.S.	Female PL-2	Clear	AC	Black	12	0.1	40700 grommet, 94789 plug	Yes

## SUPER 44<sup>®</sup>, LED, 27 DIODE, 4", FLANGE MOUNT



- Most advanced and cost-effective 4" LED back-up lamps
- 27-LED pattern lamps require the purchase of two lamps, one for each side
- 54-LED pattern lamps require the purchase of only one lamp

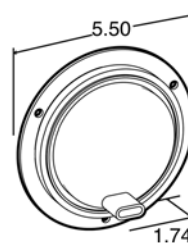

Part Number	Lamp Connector	Lens Color	Lens Material	Mount Color	Volts	Amps
44236C	Fit 'N Forget S.S.	Clear	PC	Gray	12	0.1
44239C	Fit 'N Forget S.S.	Clear	PC	White	12	0.1
44240C	Fit 'N Forget S.S.	Clear	PC	Black	12	0.1

LED  
SUPER 44

## SUPER 44<sup>®</sup>, LED, 27 DIODE, 4", FLANGE MOUNT, KIT



- Most advanced and cost-effective 4" LED Back-up lamps
- 27- LED pattern lamps require the purchase of two lamps, one for each side
- 54-LED pattern lamps require the purchase of only one lamp



Part Number	Lamp Connector	Plug Side 1	Plug Side 2	Lens Color	Lens Material	Mount Color	Volts	Amps	Kit Includes	Diamond Shell
44045C	Fit 'N Forget S.S.	Fit 'N Forget S.S.	Female PL-2	Clear	PC	Gray	12	0.1	44236C light, 94789 plug	No
44145C	Fit 'N Forget S.S.	Fit 'N Forget S.S.	Female PL-2	Clear	AC	Gray	12	0.1	94789 plug	Yes
44146C	Fit 'N Forget S.S.	Fit 'N Forget S.S.	Female PL-2	Clear	PC	Black	12	0.1	44240C light, 94789 plug	No

LED  
SUPER 44

## SUPER 44<sup>®</sup>, LED, 54 DIODE, 4", GROMMET MOUNT

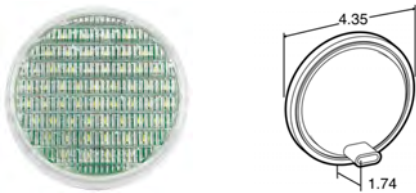

- Most advanced and cost-effective 4" LED Back-up lamps
- 27-LED pattern lamps require the purchase of two lamps, one for each side
- 54-LED pattern lamps require the purchase of only one lamp



Part Number	Lamp Connector	Lens Color	Lens Material	Mount Color	Volts	Amps
44205C	Fit 'N Forget S.S.	Clear	PC		12	0.13

LED  
SUPER 44

## SUPER 44<sup>®</sup>, LED, 54 DIODE, 4", GROMMET MOUNT, KIT



- Most advanced and cost-effective 4" LED Back-up lamps
- 27-LED pattern lamps require the purchase of two lamps, one for each side
- 54-LED pattern lamps require the purchase of only one lamp



Part Number	Lamp Connector	Plug Side 1	Plug Side 2	Lens Color	Lens Material	Mount Color	Volts	Amps	Kit Includes
44040C	Fit 'N Forget S.S.	Fit 'N Forget S.S.	Female PL-2	Clear	PC	Black	12	0.13	44205C light, 40700 grommet

## SUPER 44<sup>®</sup>, LED, 54 DIODE, 4", FLANGE MOUNT



- Most advanced and cost-effective 4" LED Back-up lamps
- 27- LED pattern lamps require the purchase of two lamps, one for each side
- 54-LED pattern lamps require the purchase of only one lamp

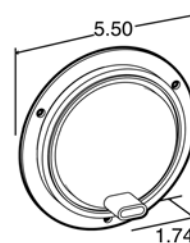

Part Number	Lamp Connector	Lens Color	Lens Material	Mount Color	Volts	Amps
44235C	Fit 'N Forget S.S.	Clear	PC	Gray	12	0.13

LED

SUPER 44

## SUPER 44<sup>®</sup>, LED, 54 DIODE, 4", FLANGE MOUNT, KIT



- Most advanced and cost-effective 4" LED Back-up lamps
- 27- LED pattern lamps require the purchase of two lamps, one for each side
- 54-LED pattern lamps require the purchase of only one lamp

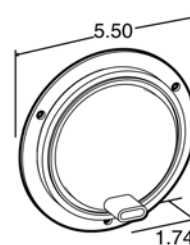

Part Number	Lamp Connector	Plug Side 1	Plug Side 2	Lens Color	Lens Material	Mount Color	Volts	Amps	Kit Includes
44044C	Fit 'N Forget S.S.	Fit 'N Forget S.S.	Female PL-2	Clear	PC	Gray	12	0.13	44235C light, 94789 plug

LED

SUPER 44

## SIGNAL-STAT, LED, 24 DIODE, 4", GROMMET MOUNT, ROUND



- Popular on owner/operator show trucks
- Uses standard right-angle connection
- Unique LED array displays a full pattern light output design
- Epoxy-encapsulated electronics resist damage from moisture and corrosion
- Less current draw, resulting in increased battery and alternator life while allowing more power for other vehicle requirements
- Two lamps required for back-up
- LEDs do not have a filament, therefore are not susceptible to damage from shock and vibration

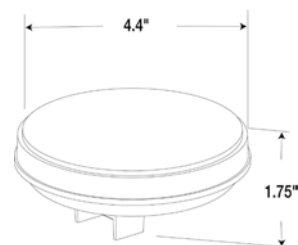

Part Number	Lamp Connector	Lens Color	Lens Material	Volts	Amps
4060C	PL-2	Clear	PC	12	0.13

LED

SIGNAL-STAT

## SIGNAL-STAT, LED, 24 DIODE, 4", FLANGE MOUNT, ROUND

LED

SIGNAL-STAT

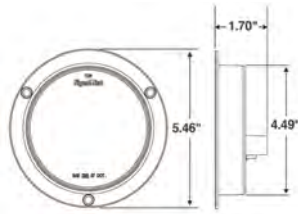

- Housing and flange are molded together to form one piece
- Uses standard right-angle PL-3 connection
- When properly mounted, exceeds FMVSS DOT requirements for back-up
- Unique LED array displays full pattern light output design
- Must be used as a two-lamp system for back-up
- Designed with impact-resistant polycarbonate
- LEDs do not have a filament, therefore are not susceptible to damage from shock and vibration
- Epoxy-encapsulated electronics resist damage from moisture and corrosion



Part Number	Lamp Connector	Lens Color	Lens Material	Mount Color	Volts	Amps
4063C	PL-3	Clear	PC	Gray	12	0.15

## 66<sup>®</sup> SERIES, LED, 1 DIODE, 2"x6", GROMMET MOUNT

LED

66 SERIES

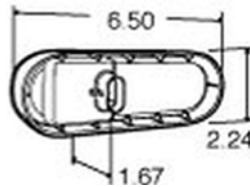

- Less current draw, resulting in increased battery and alternator life while allowing more power for other vehicle requirements
- Single-diode Technology
- Uses Fit 'N Forget™ connection for increased corrosion resistance
- Two lamps required for back-up
- Meets specifications for dome lamp applications
- Must be mounted vertically
- Patent No. - USA: 6811287, Canada: 2477643, Mexico: 250259, Australia: 2003208501



Part Number	Lamp Connector	Lens Color	Lens Material	Volts	Amps
66205C	Fit 'N Forget S.S.	Clear	PC	12	0.3

## 66<sup>®</sup> SERIES, LED, 1 DIODE, 2"x6", FLANGE MOUNT

LED

66 SERIES

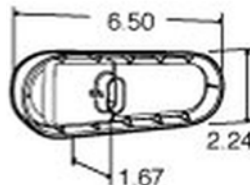

- Less current draw, resulting in increased battery and alternator life while allowing more power for other vehicle requirements
- Single-diode Technology
- Uses Fit 'N Forget™ connection for increased corrosion resistance
- Two lamps required for back-up
- Meets specifications for dome lamp applications
- Must be mounted vertically
- Patent No. - USA: 6811287, Canada: 2477643, Mexico: 250259, Australia: 2003208501



Part Number	Lamp Connector	Lens Color	Lens Material	Mount Color	Volts	Amps
66206C	Fit 'N Forget S.S.	Clear	PC	Black	12	0.3

## SIGNAL-STAT, LED, 24 DIODE, 2"X6", GROMMET MOUNT, OVAL



- Popular on owner/operator show trucks
- Uses standard right-angle connection
- 24-diode pattern
- Unique LED array displays a full pattern light output design
- Epoxy-encapsulated electronics resist damage from moisture and corrosion
- Less current draw, resulting in increased battery and alternator life while allowing more power for other vehicle requirements
- LEDs do not have a filament, therefore are not susceptible to damage from shock and vibration
- Two lamps required for back-up
- Legal mounted horizontally or vertically



Part Number	Lamp Connector	Lens Color	Lens Material	Volts	Amps
6060C	PL-2	Clear	PC	12	0.25

## SIGNAL-STAT, LED, 24 DIODE, 2"X6", FLANGE MOUNT, OVAL



- Housing and flange are molded together to form one piece
- Uses standard right-angle PL-2 connection
- When properly mounted, exceeds FMVSS DOT requirements for back-up
- Unique LED array displays full pattern light output design
- Must be used as a two-lamp system for back-up
- Designed with impact-resistant polycarbonate
- LEDs do not have a filament, therefore are not susceptible to damage from shock and vibration
- Epoxy-encapsulated electronics resist damage from moisture and corrosion
- 6063 can be legally mounted horizontally or vertically

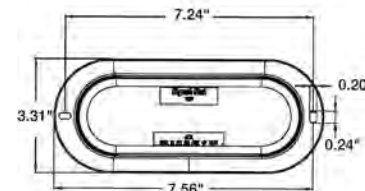

Part Number	Lamp Connector	Lens Color	Lens Material	Mount Color	Volts	Amps
6063C	PL-2	Clear	PC	Gray	12	0.25

## SIGNAL-STAT, LED, 24 DIODE, 3"X5", GROMMET MOUNT, RECTANGULAR

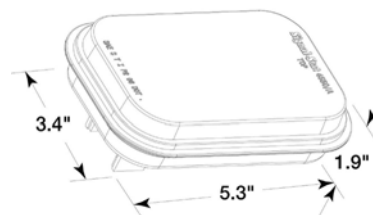

Part Number	Lamp Connector	Lens Color	Lens Material	Volts	Amps
4560C	PL-2	Clear	PC	12	0.18

## 40<sup>®</sup> SERIES, INCANDESCENT, 1 BULB, 4" , GROMMET MOUNT

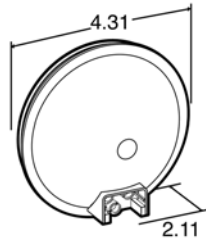

- Polycarbonate lens and housing are sonically sealed
- Bulb is shock-mounted for extended life
- Legal only for back-up function
- Not recommended for dome lamp use
- Replaces Signal-Stat 4041W and 4047W
- Upgrade to LED lighting systems using Truck-Lite's Super 44 series products



Part Number	Lamp Connector	Lens Color	Lens Material	Volts	Amps	Housing Color
40204	PL-2	Clear	PC	12	2.1	White
40206C	PL-2	Clear	PC	12	2.1	Clear
40212	PL-2	Clear	PC	24	1.02	White

## 40<sup>®</sup> SERIES, INCANDESCENT, 1 BULB, 4" , GROMMET MOUNT, KIT

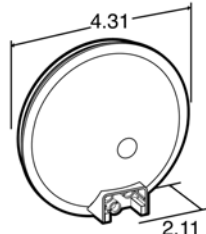

- Polycarbonate lens and housing are vibration sealed
- Bulb is shock-mounted for extended life
- Legal only for back-up function
- Not recommended for dome lamp use
- Replaces Signal-Stat 4041W and 4047W
- Upgrade to LED lighting systems using Truck-Lite's Super 44 series products



Part Number	Lamp Connector	Plug Side 1	Plug Side 2	Lens Color	Lens Material	Mount Color	Volts	Amps	Kit Includes
40004	PL-2	PL-2	Stripped End/ Ring Terminal	Clear	PC	Black	12	2.1	40204 light, 40700 grommet, 94922 plug
40012	PL-2	PL-2	Stripped End/ Ring Terminal	Clear	PC	Black	24	2.1	40700 grommet, 94922 plug
40306	Socket Assembly	Socket Assembly	Stripped End/ Ring Terminal	Clear	PC	Black	12	2.1	99010C light, 40700 grommet



### Quick Tip: Plug Side 1 vs. Plug Side 2

When buying a plug for your light it's important to understand what type of connection mates with the light and what type of termination will mate with the power harness. Plug Side 1 refers to the side of the plug that mates directly to the light. Plug Side 2 refers to the end of the plug that will mate with the power source.





## 40<sup>®</sup> SERIES, INCANDESCENT, 1 BULB, 4", FLANGE MOUNT



- Polycarbonate lens and housing are sonically sealed
- Bulb is shock-mounted for extended life
- Legal only for back-up function
- Not recommended for dome lamp use
- Replaces Signal-Stat 4041W and 4047W
- Upgrade to LED Lighting Systems using Truck-Lite's Super 44 series Products

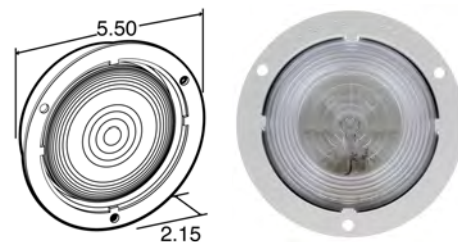

Part Number	Lamp Connector	Lens Color	Lens Material	Mount Color	Volts	Amps
40224	PL-2	Clear	PC	Gray	12	2.1
40262	PL-2	Clear	PC	Black	12	2.1

INCANDESCENT

40 SERIES

## 40<sup>®</sup> SERIES, INCANDESCENT, 27 DIODE, 4", FLANGE MOUNT, KIT



- Polycarbonate lens and housing are vibration sealed
- Bulb is shock-mounted for extended life
- Legal only for back-up function
- Not recommended for dome lamp use
- Replaces Signal-Stat 4041W and 4047W
- Upgrade to LED Lighting Systems using Truck-Lite's super 44 Series Products

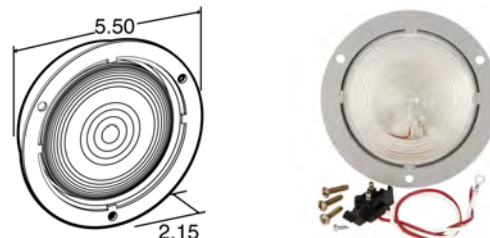

Part Number	Lamp Connector	Plug Side 1	Plug Side 2	Lens Color	Lens Material	Mount Color	Volts	Amps	Kit Includes
40024	PL-2	PL-2	Stripped End/ Ring Terminal	Clear	PC	Gray	12	2.1	40224 light, 94922 plug
40071	PL-2	PL-2	Stripped End/ Ring Terminal	Clear	PC	Black	12	2.1	40262 light 94992 plug

INCANDESCENT

40 SERIES

## Keep Your Connections Safe. Don't Forget Your Dielectric Gel.

Dielectric gel protects your lights by protecting the points of contact between elements of your lighting and harness system. Our dielectric compounds prevent arcing and corrosion and keep your lights performing as they should.

You can find our dielectric products on page 498



INCANDESCENT

SUPER 40

## SUPER 40®, INCANDESCENT, 1 BULB, 4", GROMMET MOUNT

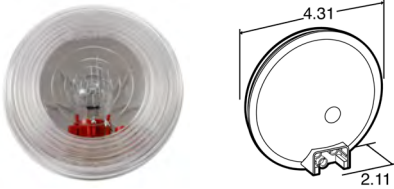

- Uniquely designed shock mount extends lamp life
- Sealed polycarbonate lens and housing resist heat and impact
- Flange and flush-mount grommets designed for mounting in a 4-1/2" hole
- Not recommended for dome lamp use
- Two lamps required to meet federal lighting regulations
- Upgrade to LED lighting systems using Truck-Lite's Super 44 series products



Part Number	Lamp Connector	Lens Color	Lens Material	Volts	Amps
40244	PL-2	Clear	PC	12	2.1

INCANDESCENT

SUPER 40

## SUPER 40®, INCANDESCENT, 1 BULB, 4", GROMMET MOUNT, KIT

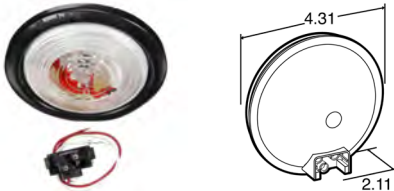

- Uniquely designed shock mount extends lamp life
- Sealed polycarbonate lens and housing resist heat and impact
- Flange and flush mount grommets designed for mounting in a 4-1/2" hole
- Not recommended for dome lamp use
- Two lamps required to meet federal lighting regulations
- Upgrade to LED lighting systems using Truck-Lite's Super 44 series products



Part Number	Lamp Connector	Plug Side 1	Plug Side 2	Lens Color	Lens Material	Mount Color	Volts	Amps	Kit Includes
40044	PL-2	PL-2	Stripped End/ Ring Terminal	Clear	PC	Black	12	2.1	40244 light, 40700 grommet, 94992 plug

INCANDESCENT

SUPER 40

## SUPER 40®, INCANDESCENT, 1 BULB, 4", FLANGE MOUNT



- Uniquely designed shock mount extends lamp life
- Sealed polycarbonate lens and housing resist heat and impact
- Flange and flush mount grommets designed for mounting in a 4-1/2" hole
- Not recommended for dome lamp use
- Two lamps required to meet federal lighting regulations
- Upgrade to LED lighting systems using Truck-Lite's Super 44 series products



Part Number	Lamp Connector	Lens Color	Lens Material	Mount Color	Volts	Amps
40260	PL-2	Clear	PC	Black	12	2.14
40261	PL-2	Clear	PC	Gray	12	2.14

## 45<sup>®</sup> SERIES, INCANDESCENT, 1 BULB, 3"x5", GROMMET MOUNT, KIT, REFLECTORIZED



- Direct replacement for approved lamps on United States Postal Service L.L.V. (Long Life Vehicle)
- Designed for mounting on a 7 - 11 degree rollback from the vertical plane
- Three versions: each features turn and hazard functions, stop and tail functions or back-up functions

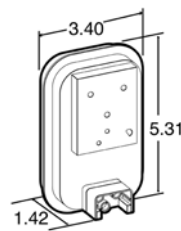

Part Number	Lamp Connector	Plug Side 1	Plug Side 2	Lens Color	Lens Material	Mount Color	Volts	Amps	Kit Includes
45024	PL-2	Right Angle PL-2	Packard Connector 12020398	Clear	PC	White	12	2.1	45701 grommet, 60701 grommet

INCANDESCENT

45 SERIES

## SUPER 45<sup>®</sup>, INCANDESCENT, 1 BULB, 3"x5", GROMMET MOUNT, REFLECTORIZED

- Heavy-duty bulb for longer life
- Mount horizontally or vertically

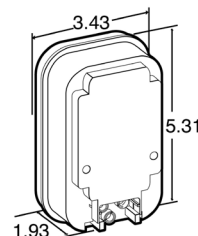

Part Number	Lamp Connector	Lens Color	Lens Material	Mount Color	Volts	Amps
45204	PL-2	Clear	PC	Black	12	2.1

INCANDESCENT

SUPER 45

## SUPER 45<sup>®</sup>, INCANDESCENT, 1 BULB, 3"x5", GROMMET MOUNT, KIT, REFLECTORIZED



- Mount horizontally or vertically
- Heavy-duty, dual filament cartridge bulb
- Unique shock mount absorbs shock and vibration

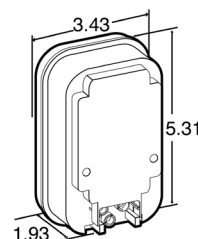

Part Number	Lamp Connector	Plug Side 1	Plug Side 2	Lens Color	Lens Material	Mount Color	Volts	Amps	Kit Includes
45004	PL-2	Right Angle PL-2	Stripped End/ Ring Terminal	Clear	PC	Black	12	2.1	45204 light, 45700 grommet, 94992 plug

INCANDESCENT

SUPER 45

## 60<sup>®</sup> SERIES, INCANDESCENT, 1 BULB, 2"X6", GROMMET MOUNT

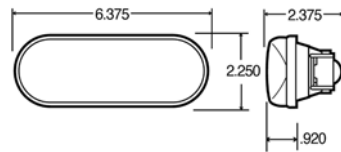

- High-impact polycarbonate lens and housing are sonically sealed
- Heavy-duty, shock mounted bulb
- Legal mounted vertically or horizontally
- Only one lamp required to meet federal lighting regulations
- Not recommended for dome lamp use
- Replaces Signal-Stat 4071W
- Upgrade to LED lighting systems using Truck-Lite's 66 Series products



Part Number	Lamp Connector	Lens Color	Lens Material	Volts	Amps
60284C	PL-2	Clear	PC	12	2.1

## 60<sup>®</sup> SERIES, INCANDESCENT, 1 BULB, 2"X6", GROMMET MOUNT, KIT,

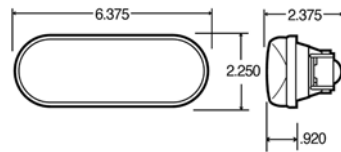

- High-impact polycarbonate lens and housing are sonically sealed
- Heavy-duty, shock mounted bulb
- Legal mounted vertically or horizontally
- Only one lamp required to meet federal lighting regulations
- Not recommended for dome lamp use
- Replaces Signal-Stat 4071W
- Upgrade to LED lighting systems using Truck-Lite's 66 Series products



Part Number	Lamp Connector	Plug Side 1	Plug Side 2	Lens Color	Lens Material	Mount Color	Volts	Amps	Kit Includes
60004C	PL-2	PL-2	Stripped End/ Ring Terminal	Clear	PC	Black	12	2.1	60204C light, 60700 grommet, 94922 plug
60345C	Socket Assembly	Socket Assembly	Stripped End/ Ring Terminal	Clear	PC	Black	12	2.1	99184C light, 60700 grommet, 95415 plug

## 60<sup>®</sup> ECONOMY, INCANDESCENT, 1 BULB, 2"X6", GROMMET MOUNT



- Vibration welded lens and housing
- Shock-mounted bulb to extend life
- Legal mounted horizontally or vertically
- Only one lamp required to meet federal lighting regulations
- Not recommended for dome lamp use
- Upgrade to LED lighting systems using Truck-Lite's 66 Series products

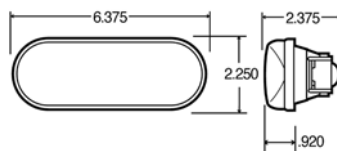

Part Number	Lamp Connector	Lens Color	Lens Material	Volts	Amps
60284C	PL-2	Clear	PC	12	2.1

INCANDESCENT

60 ECONOMY

## 60<sup>®</sup> ECONOMY, INCANDESCENT, 1 BULB, 2"X6", GROMMET MOUNT, KIT



- Vibration welded lens and housing
- Shock-mounted bulb to extend life
- Legal mounted horizontally or vertically
- Only one lamp required to meet federal lighting regulations
- Not recommended for dome lamp use
- Upgrade to LED lighting systems using Truck-Lite's 66 Series products

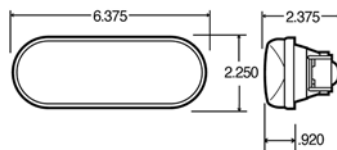

Part Number	Lamp Connector	Plug Side 1	Plug Side 2	Lens Color	Lens Material	Mount Color	Volts	Amps	Kit Includes
60092C	PL-2	PL-2	Stripped End/ Ring Terminal	Clear	PC	Black	12	2.1	60284C light, 60700 grommet, 94992 plug

INCANDESCENT

60 ECONOMY

## 80 SERIES, INCANDESCENT, 1 BULB, 4" ROUND, BRACKET MOUNT, 2 SCREW, KIT



- Features rubber body which helps absorb shock and vibration
- Can be used as back-up or utility lamp
- Requires two lamps to meet federal Lighting Regulations as a back-up lamp
- Not recommended for dome lamp use

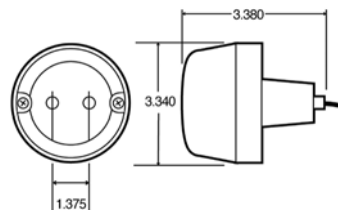

Part Number	Lamp Connector	Plug Side 1	Plug Side 2	Lens Color	Lens Material	Mount Color	Volts	Amps	Kit Includes
80340	Hardwired	Hardwired	Blunt Cut	Clear	AC	Black	12	2.1	99095C lens

INCANDESCENT

80 SERIES

## 80 SERIES, INCANDESCENT, 1 BULB, 4", BRACKET MOUNT, KIT

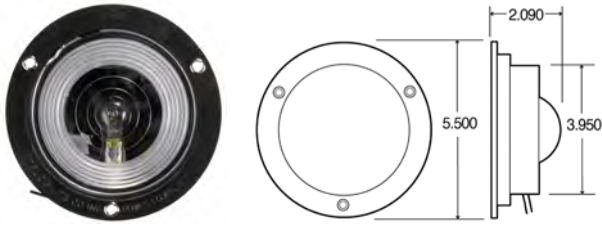

- Features rubber body which helps absorb shock and vibration
- Can be used as back-up or utility lamp
- Requires two lamps to meet federal lighting regulations as a back-up lamp
- Not recommended for dome lamp use



Part Number	Lamp Connector	Plug Side 1	Plug Side 2	Lens Color	Lens Material	Mount Color	Volts	Amps	Kit Includes
80304	Hardwired	Hardwired	Stripped End	Clear	PC	Black	12	2.1	97945 seal

## 80 SERIES, INCANDESCENT, 1 BULB, 4", FLANGE MOUNT, KIT

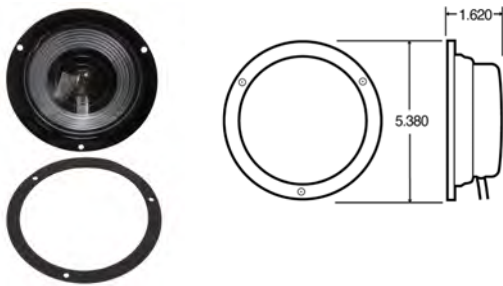

- Features flush-mount housing with recessed lens
- Snap-in retaining ring holds lens in place
- Available in three finishes - black painted steel, stainless steel or polished stainless steel
- Model 80342 requires two lamps to meet federal lighting regulations
- Replaces Signal-Stat 4111W
- Upgrade to LED lighting systems using Truck-Lite's Super 44 series products



Part Number	Lamp Connector	Plug Side 1	Plug Side 2	Lens Color	Lens Material	Mount Color	Volts	Amps
80342	Hardwired	Hardwired	Blunt Cut	Clear	PC	Black	12	2.1
80344	Hardwired	Hardwired	Blunt Cut	Clear	PC	Gray	12	2.1
80345	Hardwired	Hardwired	Blunt Cut	Clear	PC	Silver	12	2.1

## INCANDESCENT, 1 BULB, 4", GROMMET MOUNT, ROUND

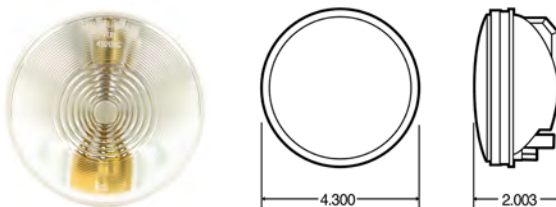

- Features male pin connections
- High-impact polycarbonate lens and housing
- Shock mount resists road shock and vibration
- Two lamps required to meet federal lighting regulations
- Not recommended for dome lamp use
- Replaces Grote #62211
- Upgrade to LED lighting systems using Truck-Lite's Super 44 series products



Part Number	Lamp Connector	Lens Color	Lens Material	Volts	Amps
49203C	PL-2	Clear	PC	12	2.1

## INCANDESCENT, 1 BULB, 4", GROMMET MOUNT, ROUND, KIT



- Features male pin connections
- High-impact polycarbonate lens and housing
- Shock mount resists road shock and vibration
- Two lamps required to meet federal lighting regulations
- Not recommended for dome lamp use
- Replaces Grote #62211
- Upgrade to LED lighting systems using Truck-Lite's Super 44 series products

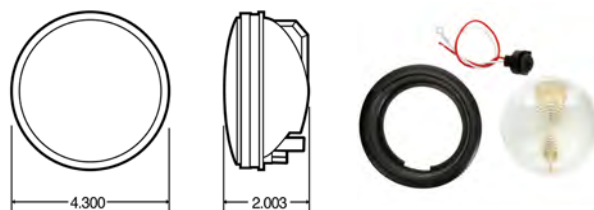

Part Number	Lamp Connector	Plug Side 1	Plug Side 2	Lens Color	Lens Material	Mount Color	Volts	Amps	Kit Includes
49003C	PL-2	Straight PL-2	Stripped End/Ring Terminal	Clear	PC	Black	12	2.1	49203C light, 40700 grommet, 96107plug

INCANDESCENT

1 BULB

## SIGNAL-STAT, INCANDESCENT, 1 BULB, 4", FLANGE MOUNT



- Narrow depth behind flange allows lamp to fit where other lamps cannot
- Mounts through 4-1/2" dia. cutout, 2" depth below flange
- Upgrade to Truck-Lite LED lighting systems using Super 44 products

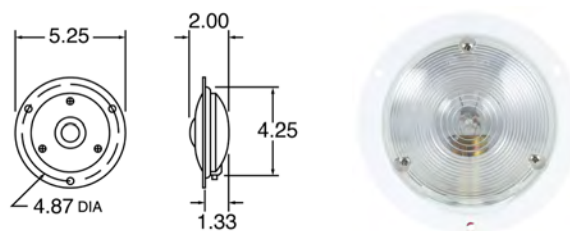

Part Number	Lamp Connector	Plug Side 1	Plug Side 2	Lens Color	Lens Material	Mount Color	Volts	Amps	Shock Mount Y/N
3613W	Hardwired	Hardwired	Stripped End	Clear	PC	Chrome	12	2.1	Y
3691W	Hardwired	Hardwired	Stripped End	Clear	PC	White	12	2.1	N
3693W	Hardwired	Hardwired	Stripped End	Clear	PC	Chrome	12	2.1	N

INCANDESCENT

1 BULB

## SIGNAL-STAT, INCANDESCENT, 1 BULB, 4", 4 SCREW BRACKET MOUNT



- Heavy-duty, economical and efficient
- Allows one light instead of two to comply with back-up lamp regulations
- Polycarbonate twist-off lens and O-ring seal
- Black plate housing: heavy gauge anodized aluminum with staked tubular bulb socket and waterproof grommet on exit wire

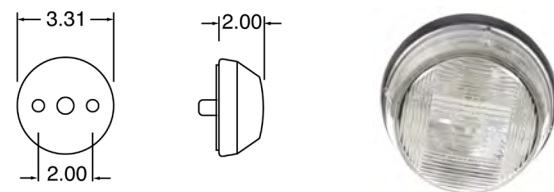

Part Number	Lamp Connector	Plug Side 1	Plug Side 2	Lens Color	Lens Material	Mount Color	Volts	Amps
92WD	Hardwired	Hardwired	Stripped End	Clear	PC	Silver	12	2.1

INCANDESCENT

1 BULB

## INCANDESCENT, 1 BULB, 2"X6", GROMMET MOUNT, RECTANGULAR

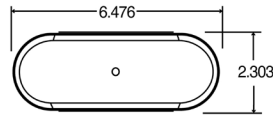
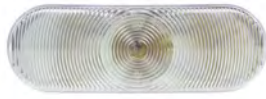

- Features male pin connections
- High-impact polycarbonate lens and housing
- Shock mount resists road shock and vibration
- Two lamps required to meet federal lighting regulations
- Not recommended for dome lamp use
- Replaces Grote #62241



Part Number	Lamp Connector	Lens Color	Lens Material	Volts	Amps
69203C	PL-2	Clear	PC	12	2.1

## INCANDESCENT, 1 BULB, 2"X6", GROMMET MOUNT, RECTANGULAR, KIT

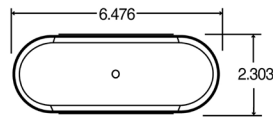

- Features male pin connections
- High-impact polycarbonate lens and housing
- Shock mount resists road shock and vibration
- Two lamps required to meet federal lighting regulations
- Not recommended for dome lamp use
- Replaces Grote #62211
- Upgrade to LED lighting systems using Truck-Lite's Super 44 series products



Part Number	Lamp Connector	Plug Side 1	Plug Side 2	Lens Color	Lens Material	Mount Color	Volts	Amps	Kit Includes
69003C	PL-2	Straight PL-2	Stripped End/Ring Terminal	Clear	PC	Black	12	2.1	69203C light, 60700 grommet, 96108 plug

## INCANDESCENT, 1 BULB, 4"X6", 4 SCREW BRACKET MOUNT, RECTANGULAR

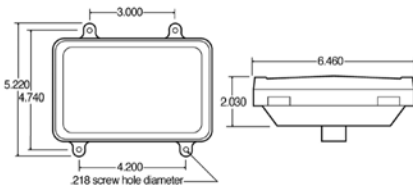

- Polycarbonate lens and housing are sealed
- Bulb socket cams-in for ease of repair/replacement (sold separately)
- Recess mounts using two screws at 3.0" centers and two screws at 4.2" centers



Part Number	Lamp Connector	Lens Color	Lens Material	Mount Color	Volts	Amps
07082C	3 Blade Terminals	Clear	PC	Clear	12	2.1
07096C	Socket Assembly	Clear	PC	White		



# Looking for even more product information?

Visit [truck-lite.com](http://truck-lite.com)



**Powerful Search  
Function**



**360° Product  
Images**



**Easy-To-Find  
Replacement  
Parts**

# WORK LIGHTS

## LED WORK LIGHTS

Pages 212-219

SERIES	PAGES
44® Series	212
60® Series	212
81 Series	212-215
Super 81 Series	216
Signal-Stat	217-219

## INCANDESCENT WORK LIGHTS

Pages 220-221

SERIES	PAGES
5in Round	220-221

## HALOGEN WORK LIGHTS



Pages 222-225

SERIES	PAGES
4in x 6in Rectangular	222-224
6in Round	225







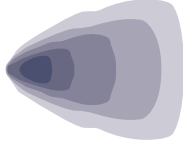

# Work Lights

Put brighter, truer light right where you need it with Truck-Lite's LED work lamps. With beam patterns ranging from direct to diffused, these auxiliary lamps get the job done in any situation.

<p><b>Shapes</b></p>	<p>Round, Oval, Rectangular, Square</p>	
<p><b>Mount Types</b></p>	<p>Stud, Bracket-mount</p>	
<p><b>Beam Patterns</b></p>	<p><b>Work</b> Broad and balanced area lighting</p>	
	<p><b>Spot</b> Focused and far-reaching</p>	
	<p><b>Flood</b> The perfect mix of distance and spread</p>	

(800) 562-5012 | [truck-lite.com](http://truck-lite.com)

 <p><b>Manufacturing &amp; Quality</b></p>	 <p><b>Testing &amp; Safety</b></p>
<p>Truck-Lite's LED auxiliary lighting is built using premium materials and backed by industry-leading warranties.</p> <p>Designed to last the life of your vehicle, Truck-Lite's solid-state construction and sealed circuitry mean that you can depend on your lights to withstand shock, vibration, moisture and debris.</p>	<p>All Truck-Lite auxiliary lamps are subjected to rigorous environmental, electrical and mechanical testing before they are validated and released to the market.</p>
 <p><b>Performance &amp; Maintenance</b></p>	 <p><b>Customer Support</b></p>
<ul style="list-style-type: none"> <li>• True-to-life light color output</li> <li>• Lower energy consumption</li> <li>• Highly controlled beam patterns</li> <li>• Impact-resistant, non-yellowing lenses and rugged housing protect against damage from even the toughest applications.</li> </ul>	<p><b>Customer Service</b>                (800) 562-5012  <a href="mailto:customerservice@truck-lite.com">customerservice@truck-lite.com</a></p> <p><b>Technical Support</b>                (888) 562-5012  <a href="mailto:tltech@truck-lite.com">tltech@truck-lite.com</a></p> <p><b>Work Light Warranties</b></p> 
<p>(800) 562-5012   <a href="http://truck-lite.com">truck-lite.com</a></p>	

## 44<sup>®</sup> SERIES, LED, 4", ROUND, FLOOD LIGHT, GROMMET MOUNT



- Features robust, cost-effective, efficient design
- Utilizes same six-diode pattern as traditional Truck-Lite 4" round LED lamps (STT, back-up, dome, etc.)
- Virtually impervious to shock and vibration
- Epoxy-encapsulated electronics protect lamp from damage caused by chemicals and moisture
- Designed to operate in extremely cold temperatures



Part Number	Housing Color	Lumens	Diodes	Lamp Connection	Plug Side 1	Plug Side 2	Volts	Amps
44304C	White	250	6	Hardwired	Hardwired	Blunt Cut	12	0.53

## 60<sup>®</sup> SERIES, LED, 2"X 6", OVAL, WORK LIGHT, GROMMET MOUNT

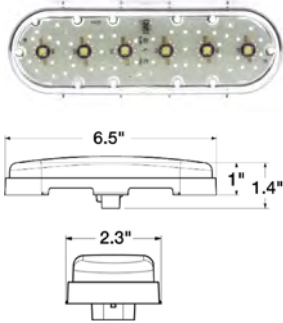

- Optic-free lens allows for smooth, ambient distribution of light
- Lens/housing constructed of high-grade, impact-resistant polycarbonate
- White LEDs offer daylight-bright visibility, cleaner and clearer than other light source options
- Fits into Truck-Lite 60 Series footprint, allowing for a simple retrofit of existing incandescent lamps as well as the use of existing 60 Series accessories (grommets, flanges, etc.)
- Less current draw, resulting in increased battery and alternator life while allowing more power for other vehicle requirements
- Fit 'N Forget™ connection for increased corrosion resistance
- Perfect for lighting instruments beneath vehicle



Part Number	Housing Color	Lumens	Diodes	Lamp Connection	Volts	Amps
60354C	White	450	6	Fit 'N Forget S.S.	12	0.78

## 81 SERIES, LED, 4", ROUND, WORK LIGHT, GROMMET MOUNT

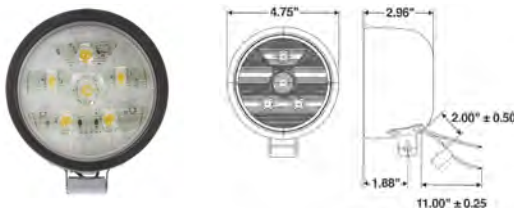

Part Number	Housing Color	Lumens	Diodes	Lamp Connection	Plug Side 1	Plug Side 2	Volts	Amps
81261	Black	250	6	Hardwired	Hardwired	Stripped End	12	0.55

# 81 SERIES, LED, 4", ROUND, MULTIPLE PATTERNS



- Manufactured under design patent# US D572,856 S
- Rugged, all-purpose work lamp
- More even lighting than comparable incandescent work lamps
- LED light is whiter and brighter than comparable incandescent lamps
- LEDs have no filament, therefore are extremely resistant to shock and vibration
- 81360/81374/81365-overvoltage protection @ 17v-18v
- 81240/81270/81245-overvoltage protection @ 34v-36v
- Includes stainless steel mounting hardware
- Mounts on one 5/16"-18 stud

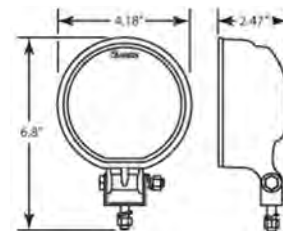

BLACK



WHITE



CHROME



WORK



FLOOD



SPOT

## WORK LIGHTS



Broad and balanced area lighting



Replacement Hardware:  
Part No. 97432

Part Number	Housing Color	Lumens	Diodes	Lamp Connection	Plug Side 1	Plug Side 2	Volts	Amps
81365	Chrome	361	6	Hardwired	Hardwired	Stripped End	12	1.2
81245	Chrome	500	6	Hardwired	Hardwired	Stripped End	24	0.5
81374	White	500	6	Hardwired	Hardwired	Blunt Cut	12	1.2
81270	White	500	6	Hardwired	Hardwired	Stripped End	24	0.5
81371	Black	500	6	Hardwired	Hardwired	Stripped End	12	1.2
81240	Black	500	6	Hardwired	Hardwired	Blunt Cut	24	0.5
81360	Black	388	6	Hardwired	Hardwired	Stripped End	12	1.2

## FLOOD LIGHTS



The perfect mix of distance and spread

Part Number	Housing Color	Lumens	Diodes	Lamp Connection	Plug Side 1	Plug Side 2	Volts	Amps
81250	Black	500	10	Hardwired	Hardwired	Stripped End	24	0.5
81255	Chrome	453	6	Hardwired	Hardwired	Blunt Cut	24	0.5
81260	Black	250	6	Hardwired	Hardwired	Blunt Cut	12	0.53
81380	Black	388	6	Hardwired	Hardwired	Stripped End	12	1.2
81385	Chrome	500	6	Hardwired	Hardwired	Blunt Cut	12	1.2

## SPOT LIGHTS



Focused and far-reaching

Part Number	Housing Color	Lumens	Diodes	Lamp Connection	Plug Side 1	Plug Side 2	Volts	Amps
81390	Black	417	6	Hardwired	Hardwired	Stripped End	12	1.2
81391	White	362	6	Hardwired	Hardwired	Stripped End	12	1.2
81290	Black	500	6	Hardwired	Hardwired	Stripped End	24	0.5
81291	White	500	6	Hardwired	Hardwired	Blunt Cut	24	0.5
81295	Chrome	500	6	Hardwired	Hardwired	Stripped End	24	0.5
81395	Chrome	417	6	Hardwired	Hardwired	Stripped End	12	1.2

# 81 SERIES, LED, 7", ROUND, MULTIPLE PATTERNS

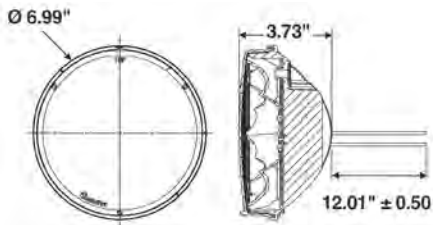

- Provides a robust, LED, solid-state solution to applications in need of additional lighting
- Popular for use as auxiliary lighting for off-road, utility, construction applications and more
- Offers a unique appearance, especially when installed with Truck-Lite LED headlight
- Displays a wide, uniform, symmetrical light output pattern
- Offers longer life than comparable incandescent lights
- Provides a brighter, crisper and whiter light output closer to the color temperature of daylight, dramatically improving light projection distance and overall visibility
- Metalized reflector directs light output effectively, increasing visibility
- Hardwired design and fully encapsulated electronics protect from damage caused by corrosive element
- Voltage spike protected to 600v



WORK



FLOOD



SPOT

## WORK LIGHTS Broad and balanced area lighting

Part Number	Housing Color	Lumens	Diodes	Lamp Connection	Plug Side 1	Plug Side 2	Volts	Amps	Mount Type
81702	Black	1420	10	Hardwired	Hardwired	Blunt Cut	12	4.2	Bracket
81712	Black	1420	10	Hardwired	Hardwired	Blunt Cut	12	4.2	Integral Bracket

## FLOOD LIGHTS The perfect mix of distance and spread

Part Number	Housing Color	Lumens	Diodes	Lamp Connection	Plug Side 1	Plug Side 2	Volts	Amps	Mount Type
81704	Black	1500	10	Hardwired	Hardwired	Blunt Cut	12	4.2	Bracket
81714	Black	1500	10	Hardwired	Hardwired	Blunt Cut	12	4.2	Integral Bracket
81804	Black	1500	10	Hardwired	Hardwired	Blunt Cut	24	1.5	Bracket

## SPOT LIGHTS Focused and far-reaching

Part Number	Housing Color	Lumens	Diodes	Lamp Connection	Plug Side 1	Plug Side 2	Volts	Amps	Mount Type
81701	Black	1200	10	Hardwired	Hardwired	Blunt Cut	12	4.2	Bracket
81711	Black	1200	10	Hardwired	Hardwired	Blunt Cut	12	4.2	Integral Bracket
81801	Black	1200	10	Hardwired	Hardwired	Stripped End	24	1.6	Bracket



## 81 SERIES, LED, 2"X 4", RECTANGULAR, WORK LIGHT



- Adds up to five feet of valuable lighting to the perimeter of your vehicle, increasing visibility in areas in which dome or back-up lighting will not reach
- Low-profile lamp protrudes only 2.5" from vehicle surface, while projecting light far beyond lamp surface
- Heavy-duty, die-cast aluminum housing with gray powder-coated surface
- Impact-resistant polycarbonate lens
- Rear fins keep heat away from LEDs and lamp circuitry
- White LEDs offer daylight-like visibility, cleaner and clearer than other light source options
- Minimal electrical draw (1.2a) allows for the use of multiple lamps, without demanding significant power from vehicle
- Hardwired .180 bullet terminals prevent pin corrosion at lamp, and install without adapters or additional wiring connections
- Ideal for use with liftgate trailers and body vehicles
- Care should be taken to install this device so that it cannot operate while the trailer or vehicle is in motion

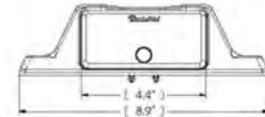
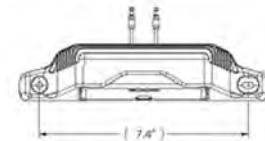
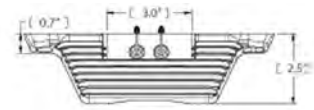

Part Number	Housing Color	Lumens	Diodes	Lamp Connection	Plug Side 1	Plug Side 2	Volts	Amps
81335C	Chrome	359	4	Hardwired	Hardwired	.180 Bullet	12	1.2

## 81 SERIES, LED, 4"X 6", RECTANGULAR, FORKLIFT WORK LIGHT

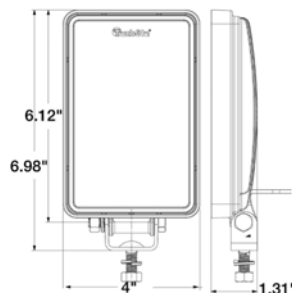

- UL recognized
- 12V to 48V operation
- Advanced LED technology designed for all types of material handling applications
- Vertical beam pattern is ideal for handling of large loads with obstructed views
- Elongated pattern lights up aisles and loading paths while preventing glare caused by light reflecting off carried boxes
- Pattern lights up stocking racks from floor to ceiling
- Solid-state design is ideal for use in high shock and vibration applications
- Sealed lens and potted electronics are suitable for exterior use
- Low-profile design and impact-resistant aluminum housing and polycarbonate lens prevent damage from collisions with racking systems
- OmniVolt design allows a single lamp to be stocked for all material handling applications, eliminating the need to carry multiple lamps with varying voltage systems
- Significantly lower current draw than traditional material handling lighting systems

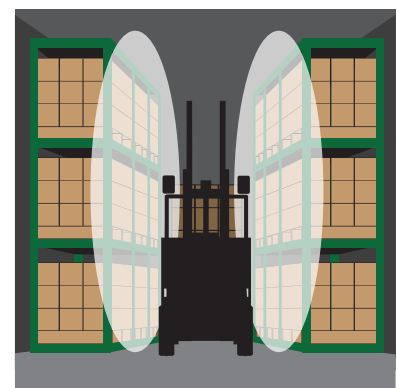

Part Number	Housing Color	Lumens	Diodes	Lamp Connection	Plug Side 1	Plug Side 2	Volts	Amps
81560	Black	766	12	Hardwired	Hardwired	Stripped End	12 24 36 48	1.24

# SUPER 81 SERIES, LED, 4", SQUARE, WORK LIGHTS

LED

SUPER 81 SERIES

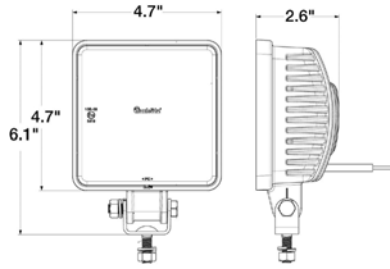

- Heavy-duty housing is constructed of die-cast aluminum
- Lens manufactured of impact-resistant polycarbonate
- Circuitry protected by triple-pass conformal coating
- Rear fins keep heat away from leds and lamp circuitry
- Allowing for increased light output and lamp longevity
- White leds offer daylight-like visibility
- Current-regulated switching circuit
- 18 gauge ADR Compliant wires
- ECE Reg 10-3 EMI Compliant
- 10V-30V OnmiVolt
- SAE voltage spike protected



81500



81510



81520



Part Number	Housing Color	Lumens	Diodes	Lamp Connection	Plug Side 1	Plug Side 2	Volts	Amps
81500	Black	2650	12	Hardwired	Hardwired	Blunt Cut	12 24	2.52
81510	Black	1890	8	Hardwired	Hardwired	Blunt Cut	12 24	2.04
81520	Black	774	4	Hardwired	Hardwired	Blunt Cut	12 24	.86



81500 LIGHT PATTERN

## SIGNAL-STAT, LED, 3", ROUND, FLOOD LIGHT



- Heavy-duty, die-cast aluminum housing
- Impact-resistant polycarbonate lens
- Rear fins keep heat away from LEDs and lamp circuitry
- White LEDs offer daylight-like visibility, cleaner and clearer than other light source options
- Current-regulated switching circuit
- Overvoltage protection
- SAE voltage shock protection
- EMC protection and IP 67 certified

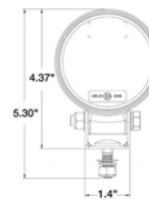

Part Number	Housing Color	Lumens	Diodes	Lamp Connection	Plug Side 1	Plug Side 2	Volts	Amps
8140	Black	700	4	Hardwired	Hardwired	Blunt Cut	12 24 36	0.49

LED

SIGNAL-STAT

## SIGNAL-STAT, LED, 4", ROUND, WORK LIGHT



- Work pattern is ideal for light utility, construction, agricultural, airport and tow trucks, state and highway departments
- Provides a brighter, crisper and whiter light output, closer to the color temperature of daylight
- OmniVolt technology allows use at 9 to 36 volts without switching
- Internal electronics completely encapsulated in epoxy, protecting against damage caused by moisture and corrosion
- Black powder-coated aluminum housing offers impact and corrosion resistance
- Offers longer life than incandescent lamps, saving time and money on replacements

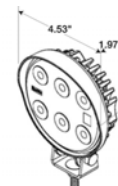

Part Number	Housing Color	Lumens	Diodes	Lamp Connection	Plug Side 1	Plug Side 2	Volts	Amps
8150	Black	654	8	Hardwired	Hardwired	Stripped End	12 24 36	1.03

LED

SIGNAL-STAT

## SIGNAL-STAT, LED, 4", ROUND, WORK LIGHT



- Fits into any standard Par 36 bulb application
- Perfect for retrofitting inefficient incandescent Par 36 lamps to high-efficiency LED lighting
- Offers clear, white LED auxiliary illumination needed for many off-road, agricultural or general lighting needs
- Heavy-duty powder coating provides excellent protection against the elements
- Die-cast aluminum housing
- Vertical heat sink pulls heat from the housing, increasing LED lifespan
- Blunt-cut terminals allow for a diverse range of applications
- OmniVolt (9V-36V) design, works for 12V and 24V system

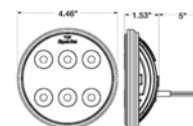

Part Number	Housing Color	Lumens	Diodes	Lamp Connection	Plug Side 1	Plug Side 2	Volts	Amps
80220	Black	521	8	Hardwired	Hardwired	Stripped End	12 24 36	1.06

LED

SIGNAL-STAT

## SIGNAL-STAT, LED, 4", ROUND, FLOOD LIGHT



- Fits into any standard Par 36 bulb application
- Perfect for retrofitting inefficient incandescent Par 36 lamps to high-efficiency LED lighting
- Offers clear, white LED auxiliary illumination needed for many off-road, agricultural or general lighting needs
- Heavy-duty powder coating provides excellent protection against the elements
- Die-cast aluminum housing
- Vertical heat sink pulls heat from the housing, increasing LED lifespan
- Blunt-cut terminals allow for a diverse range of applications
- 500 Lumen output designed at 1.06 amps
- OmniVolt (9V-36V) design, works for 12V and 24V system



Part Number	Housing Color	Lumens	Diodes	Lamp Connection	Plug Side 1	Plug Side 2	Volts	Amps
80240	Black	736	8	Hardwired	Hardwired	Deutsch Connector	12 24 36	0.5

## SIGNAL-STAT, LED, 4" X 6", OVAL, FLOOD LIGHT



- Heavy-duty, die-cast aluminum housing
- Lens manufactured with impact-resistant polycarbonate material
- Rear fins keep heat away from LEDs and lamp circuitry, allowing for increased light output and light longevity
- White LEDs offer daylight-like visibility, cleaner and clearer than other light source options
- Current-regulated switching circuit
- Overvoltage protection
- SAE voltage shock protection
- EMC protection and IP 67 certified



Part Number	Housing Color	Lumens	Diodes	Lamp Connection	Plug Side 1	Plug Side 2	Volts	Amps
8180	Black	1400	8	Hardwired	Hardwired	Blunt Cut	12 24 36	1

## SIGNAL-STAT, LED, 4" X 6", OVAL, WORK LIGHT



- Heavy-duty, die-cast aluminum housing
- Lens manufactured with impact-resistant acrylic material
- Rear fins keep heat away from LEDs and lamp circuitry, allowing for increased light output and light longevity
- White LEDs offer daylight-like visibility, cleaner and clearer than other light source options
- Current-regulated switching circuit
- EMC protection



Part Number	Housing Color	Lumens	Diodes	Lamp Connection	Plug Side 1	Plug Side 2	Volts	Amps
8193	Black	1900	8	Deutsch Connector	Deutsch Connector	Stripped End	12 24	1.21

## SIGNAL-STAT, LED, 4" X 3.75", RECTANGULAR, WORK LIGHT



- Work pattern is ideal for light utility, construction, agricultural, airport and tow trucks, state and highway departments
- Provides a brighter, crisper and whiter light output, closer to the color temperature of daylight, dramatically improving light projection distance and overall visibility
- Internal electronics completely encapsulated in epoxy, protecting against damage caused by moisture and corrosion
- Black powder-coated aluminum housing offers resistance to impact and corrosion
- Offers longer life than incandescent lamps, saving time and money on replacements

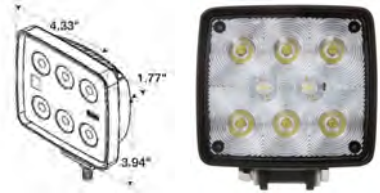

Part Number	Housing Color	Lumens	Diodes	Lamp Connection	Plug Side 1	Plug Side 2	Volts	Amps
8155	Black	638	8	Hardwired	Hardwired	Stripped End	12 24 36	1.03
8160	Black	819	10	Hardwired	Hardwired	Stripped End	12 24 36	1.08

LED

SIGNAL-STAT

## SIGNAL-STAT, LED, 3" X 3", SQUARE, WORK LIGHT



- Heavy-duty, die-cast aluminum housing
- Lens manufactured with impact-resistant acrylic material
- Rear fins keep heat away from LEDs and lamp circuitry, allowing for increased light output and light longevity
- White LEDs offer daylight-like visibility, cleaner and clearer than other light source options
- Current regulated switching circuit
- EMC protection
- Includes stainless steel bracket mount



Part Number	Housing Color	Lumens	Diodes	Lamp Connection	Plug Side 1	Plug Side 2	Volts	Amps
8192	Black	1200	5	Hardwired	Hardwired	Blunt Cut	12 24	.58

LED

SIGNAL-STAT

## SIGNAL-STAT, LED, 4" X 4", SQUARE, FLOOD LIGHT



- Provides a brighter, crisper and whiter light output, closer to the color temperature of daylight, dramatically improving light projection distance and overall visibility
- Internal electronics completely encapsulated in epoxy, protecting against damage caused by moisture and corrosion
- Black powder-coated aluminum housing offers impact and corrosion resistance
- Offers longer life than incandescent lamps, saving time and money on replacements



Part Number	Housing Color	Lumens	Diodes	Lamp Connection	Plug Side 1	Plug Side 2	Volts	Amps
8170	Black	846	9	Hardwired	Hardwired	Stripped End	12 24 36	1.51

LED

SIGNAL-STAT

## INCANDESCENT, 5", ROUND, WORK LIGHT

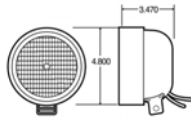

- Durable synthetic rubber housing resists corrosion
- Includes mounting hardware
- Contains one clear Par 36 sealed trapezoid beam with multipurpose terminals
- Fluted lens disperses light evenly
- Mounts on one 5/16"-18 stud



Part Number	Housing Color	Bulbs	Lamp Connection	Plug Side 1	Plug Side 2	Volts	Amps	Mount Type
80438	Black	1	Hardwired	Hardwired	Blunt Cut	12	2.9	
80378	Black	1	Hardwired	Hardwired	S/A Wire W/MLD BLLT	12	2.9	
80375	Black	1	Hardwired	Hardwired	Stripped End	24	2.1	
80373	Black	1	Hardwired	Hardwired	Blunt Cut	12	2.9	Rear Mounted

## INCANDESCENT, 5", ROUND, WORK LIGHT

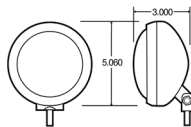

- Heavy-gauge steel housing is powder-coated in black epoxy
- Includes mounting hardware
- Contains one clear Par 36 sealed trapezoid beam with multipurpose terminals
- Fluted lens disperses light evenly
- Mounts on one 5/16"-18 stud



Part Number	Housing Color	Bulbs	Lamp Connection	Plug Side 1	Plug Side 2	Volts	Amps
80364	Black	1	Hardwired	Hardwired	Stripped End	12	2.9

## INCANDESCENT, 5", ROUND, WORK LIGHT

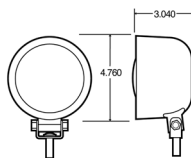

- Durable synthetic rubber housing resists corrosion
- Includes mounting hardware
- Contains one clear Par 36 sealed trapezoid beam with multipurpose terminals
- Fluted lens disperses light evenly
- Mounts on one 5/16"-18 stud



Part Number	Housing Color	Bulbs	Lamp Connection	Plug Side 1	Plug Side 2	Volts	Amps
80361	Black	1	Hardwired	Hardwired	Blunt Cut	12	2.9
80360	Black	1	Hardwired	Hardwired	Stripped End	12	2.9

## INCANDESCENT, 5", ROUND, WORK LIGHT



- Durable synthetic rubber housing resists corrosion
- Includes mounting hardware
- Contains one clear Par 36 sealed trapezoid beam with multipurpose terminals
- Fluted lens disperses light evenly
- Mounts on one 5/16" -18 stud

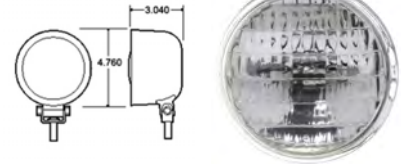

Part Number	Bulbs	Lamp Connection	Plug Side 1	Plug Side 2	Volts	Amps
80203	1	Two Screw Terminal	No Plug	No Plug	24	2.1
80200	1	Two Screw Terminal	No Plug	No Plug	12	2.9

INCANDESCENT

5 IN

## SIGNAL-STAT, INCANDESCENT, 5", ROUND, WORK LIGHT



- Rugged, all-purpose lamp
- Screw-on bulb connections for positive contact and easy bulb replacement
- Single wire-stud ground
- Weatherproof rubber shell for extended bulb life
- Shell remains flexible from -40°F to 125°F
- Housing available separately
- 1/2" diameter adjustable ball stud
- Replaces Truck-Lite 80384

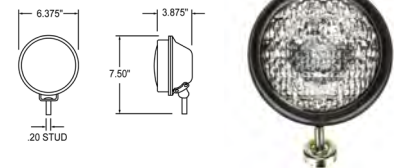

Part Number	Housing Color	Bulbs	Lamp Connection	Plug Side 1	Plug Side 2	Volts	Amps
630W	Black	1	Hardwired	Hardwired	Stripped End	12	3.9
630W4	Black	1	Hardwired	Hardwired	Stripped End	24	2.3

INCANDESCENT

5 IN

## SIGNAL-STAT, INCANDESCENT, 5", ROUND, WORK LIGHT



- Ideal for agricultural applications
- Functions as tractor, utility, alley or hook-up lamp for fifth wheel
- Screw-on bulb connections for positive contact and easy bulb replacement
- Single wire, stud ground
- Weatherproof rubber shell protects sealed beam for longer life
- Shell remains flexible from -40°F to 125°
- Adjustable bracket with 5/16" diameter stud



Part Number	Housing Color	Bulbs	Lamp Connection	Plug Side 1	Plug Side 2	Volts	Amps
620W	Black	1	Hardwired	Hardwired	Blunt Cut	12	2.9
620W4	Black	1	Hardwired	Hardwired	Stripped End	24	2.1

INCANDESCENT

5 IN

## INCANDESCENT, 5", ROUND, SPOT LIGHT



- Durable synthetic rubber housing resists corrosion
- Includes mounting hardware
- Contains one clear Par 36 sealed trapezoid beam with multipurpose terminals
- Mounts on one 5/16"-18 stud

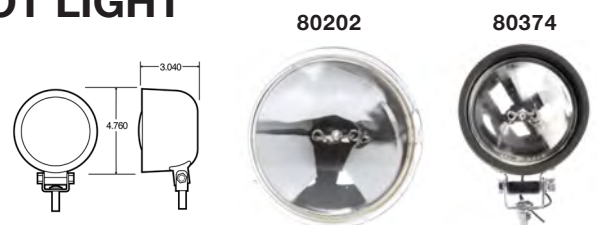

Part Number	Housing Color	Bulbs	Lamp Connection	Plug Side 1	Plug Side 2	Volts	Amps
80202		1	Two Screw Terminal	No Plug	No Plug	12	8.3
80374	Black	1	Hardwired	Hardwired	Stripped End	12	8.3

INCANDESCENT

5 IN

## HALOGEN, 4" X 6", RECTANGULAR, WORK LIGHT

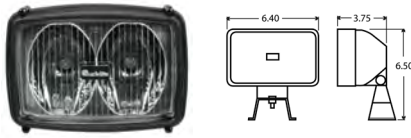

- Intelligent, high-performance solution for wide variety of work lamp applications
- Two beams mean twice the lighting output of a conventional single beam unit
- For single installations, this translates to significant cost savings while producing the same output as two traditional lamps
- For true high performance, installation of 2 two-beam lamps results in phenomenal four lamp illumination
- Bracket allows full tilt and 360° rotation adjustment



Part Number	Housing Color	Lumens	Bulbs	Lamp Connection	Plug Side 1	Plug Side 2	Volts	Amps
80498	Black	1450	2	Hardwired	Hardwired	Stripped End	12	4.5

## HALOGEN, 4" X 6", RECTANGULAR, WORK LIGHTS



80394

80388  
Driving Beam

- Durable synthetic rubber housing resists corrosion
- Includes mounting hardware
- Universal mount uses one 5/16"-18 stud
- Contains one glass rectangular sealed halogen beam with two right-angle terminals
- Fluted lens disperses light evenly



Part Number	Housing Color	Bulbs	Lamp Connection	Plug Side 1	Plug Side 2	Volts	Amps
80394	Black	1	Hardwired	Hardwired	Stripped End	12	4.2
80388	Black	1	Hardwired	Hardwired	Stripped End	12	4.2

## HALOGEN, 4" X 6", RECTANGULAR, MEDIUM FLOOD LIGHT



- Durable synthetic rubber housing resists corrosion
- Includes mounting hardware
- Universal mount uses one 5/16"-18 stud
- Contains one glass rectangular sealed halogen beam with two right-angle terminals
- Fluted lens disperses light evenly



Part Number	Housing Color	Bulbs	Lamp Connection	Plug Side 1	Plug Side 2	Volts	Amps
80395	Black	1	Hardwired	Hardwired	Stripped End	12	4.2

## HALOGEN, 4" X 6", RECTANGULAR, WIDE FLOOD LIGHT



- Durable synthetic rubber housing resists corrosion.
- Includes mounting hardware.
- Universal mount uses one 5/16"-18 stud.
- Contains one glass rectangular sealed halogen beam with two right angle terminals.
- Fluted lens disperses light evenly.



Part Number	Housing Color	Bulbs	Lamp Connection	Plug Side 1	Plug Side 2	Volts	Amps
80396	Black	1	Hardwired	Hardwired	Stripped End	12	4.2

HALOGEN

4 IN X 6 IN

HALOGEN

4 IN X 6 IN

HALOGEN

4 IN X 6 IN

HALOGEN

4 IN X 6 IN



## HALOGEN, 4" X 6", RECTANGULAR

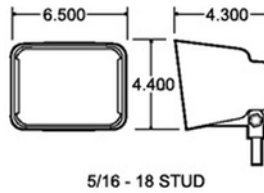

80207



80205



80209



80206

Part Number	Bulbs	Lamp Connection	Plug Side 1	Plug Side 2	Volts	Amps	Beam Pattern
80205	1	Two Right Angle Lugs	No Plug	No Plug	12	4.2	Wide Flood
80206	1	Two Right Angle Lugs	No Plug	No Plug	12	4.2	Work
80207	1	Two Right Angle Lugs	No Plug	No Plug	12	4.2	Medium Flood
80209	1	Two Right Angle Lugs	No Plug	No Plug	12	3.91	Spot

HALOGEN

4 IN X 6 IN

## HALOGEN, 4" X 6", RECTANGULAR



- Durable synthetic rubber housing resists corrosion
- Includes mounting hardware
- Universal mount uses one 5/16"-18 stud
- Contains one glass rectangular sealed halogen beam with two right-angle terminals
- Fluted lens disperses light evenly

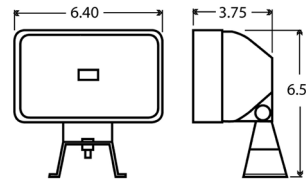

Part Number	Housing Color	Lumens	Bulbs	Lamp Connection	Plug Side 1	Plug Side 2	Volts	Amps	Beam Pattern
80491	Black	1450	2	Hardwired	Hardwired	Stripped End	12	4.5	Flood
80492	Black	1450	2	Hardwired	Hardwired	Stripped End	12	4.5	Spot
80493	Black	1450	2	Hardwired	Hardwired	Stripped End	12	4.5	Flood (Single Beam)
80494	Black	1450	2	Hardwired	Hardwired	Stripped End	12	4.5	Flood w/switch

HALOGEN

4 IN X 6 IN

## HALOGEN, 4" X 6", RECTANGULAR, SPOT LIGHT



- Clear lens increases output by 30-50%
- Compact 3" x 5" design
- Performs brighter and wider than larger lamps
- Bracket allows full tilt and 360° rotation adjustment
- Pre-wired with bulb

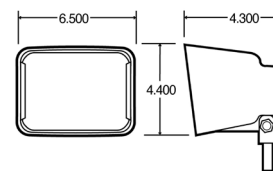

Part Number	Housing Color	Bulbs	Lamp Connection	Plug Side 1	Plug Side 2	Volts	Amps
80397	Black	1	Hardwired	Hardwired	Stripped End	12	4.2

HALOGEN

4 IN X 6 IN

HALOGEN

4 IN X 6 IN

## SIGNAL-STAT, HALOGEN, 4" X 6", RECTANGULAR, WORK LIGHT

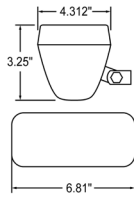

- Direct Hobbs replacement
- Durable hard plastic housing will not weather or rust
- Advanced 55W H3 bulb technology means inexpensive bulb replacement instead of captive sealed beam replacement
- To convert these lamps to 24V - change bulb to #80561
- 1/2" adjustable hollow stud



Part Number	Housing Color	Lumens	Bulbs	Lamp Connection	Plug Side 1	Plug Side 2	Volts	Amps
610W	Black	1450	1	Hardwired	Hardwired	Blunt Cut	12	4.5

HALOGEN

4 IN X 6 IN

## SIGNAL-STAT, HALOGEN, 4" X 6", RECTANGULAR, WORK LIGHT

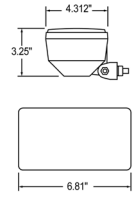

- Rugged molded PVC housing will not break or weather - remains flexible from -40° to 120°F
- Advanced 55W H3 bulb design eliminates the need for expensive sealed beam replacement
- Precision optics
- Adjustable bracket with 5/16" stud



Part Number	Housing Color	Lumens	Bulbs	Lamp Connection	Plug Side 1	Plug Side 2	Volts	Amps
627WD	Black	1450	1	Hardwired	Hardwired	Stripped End	12	4.5

HALOGEN

4 IN X 6 IN

## SIGNAL-STAT, HALOGEN, 4" X 6", RECTANGULAR, SPOT LIGHT

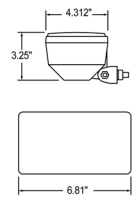

- Direct Hobbs replacement
- Durable hard plastic housing will not weather or rust
- Advanced 55W H3 bulb technology means inexpensive bulb replacement instead of captive sealed beam replacement
- To convert these lamps to 24V - change bulb to #80561
- 1/2" adjustable hollow stud



Part Number	Housing Color	Lumens	Bulbs	Lamp Connection	Plug Side 1	Plug Side 2	Volts	Amps
629WD	Black	1450	1	Hardwired	Hardwired	Stripped End	12	4.5

HALOGEN

4 IN X 6 IN

## SIGNAL-STAT, HALOGEN, 4" X 6", RECTANGULAR, SPOT LIGHT

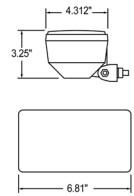

- Direct Hobbs replacement
- Durable hard plastic housing will not weather or rust
- Advanced 55W H3 bulb technology means inexpensive bulb replacement instead of captive sealed beam replacement
- To convert these lamps to 24V - change bulb to #80561
- 1/2" adjustable hollow stud



Part Number	Housing Color	Lumens	Bulbs	Lamp Connection	Plug Side 1	Plug Side 2	Volts	Amps
628WD	Black	1450	1	Hardwired	Hardwired	Stripped End	12	4.5

# HALOGEN, 6", ROUND, FLOOD LIGHT



- Rugged, all-purpose lamp
- Screw-on bulb connections for positive contact and easy bulb replacement
- Single wire-stud ground
- Weatherproof rubber shell for extended bulb life
- Shell remains flexible from -40°F to 125°F
- Housing available separately
- 1/2" diameter adjustable ball stud
- Replaces Truck-Lite 80384

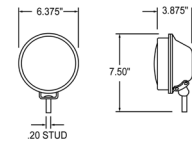

Part Number	Housing Color	Bulbs	Lamp Connection	Plug Side 1	Plug Side 2	Volts	Amps
632W	Black	1	Hardwired	Hardwired	Stripped End	12	3.9
633W	Black	1	Hardwired	Hardwired	Stripped End	12	3.9

HALOGEN

4 IN X 6 IN

# Looking for even more product information?

Visit [truck-lite.com](http://truck-lite.com)



**Powerful Search Function**



**360° Product Images**



**Easy-To-Find Replacement Parts**

# HEADLIGHTS & FOG LIGHTS

## HEADLIGHTS

Pages 230-236

### LED

SERIES	PAGES
4" X 6"	230
5" x 7"	231
7in Round	232-233
ECE	234

### HALOGEN

SERIES	PAGES
4" x 6"	235
5" x 7"	235
7" Round	236

## LED

SERIES	PAGES
4" Round	238
44 Series	238
45 Series	239
Rigid Industries	240-243

## INCANDESCENT

SERIES	PAGES
4" Round	244
5" Round	244
6" Round	244
3" x 5" Driving Light	245

## HALOGEN

SERIES	PAGES
3" x 5" Rectangular	245-246
3" x 6" Rectangular	246
3" x 7" Driving Light	246-247
4" x 6" Rectangular	247

## LED

SERIES	PAGES
7" Round	248-249
5" x 7"	250

## INCANDESCENT

SERIES	PAGES
4" x 6"	251-255



# Headlights and Fog Lights

Originally developed for the United States military, Truck-Lite's LED headlights bring combat-ready ruggedness and true-to-life color output to the civilian market in a variety of applications, whether it's heavy-duty trucks, off-road vehicles, motorcycles or classic cars.

## Shapes

7" Round, 5"x7" Rectangular, 4"x6" Rectangular

## Standards

### **DOT - Department of Transportation**

The DOT functions as a governmental umbrella for anything dealing with transportation. DOT lettering is often put on lights to show that they conform to all government regulations.

### **NHTSA - National Highway Traffic Safety Administration**

The NHTSA regulates lighting requirements for new road vehicles. Regulations take precedence over state laws and have the power to implement fines, recalls, and new regulations.

### **FMCSA - Federal Motor Carrier Safety Administration**

The FMCSA issues Federal Motor Carrier Safety Regulations (FMCSR), which regulate vehicles over 80" wide







### **FMVSS-108 - Federal Motor Vehicle Safety Standard 108**

The federal code that regulates lighting and performance requirements. NHTSA publishes the 108 regulations.

### **CMVSS-108 - Canadian Motor Vehicle Safety Standard 108**

Canada's regulation code, analogous to FMVSS 108. The primary differences are that the CMVSS 108 requires daytime running lamps and allows European headlights, while FMVSS 108 does not.

(800) 562-5012 | [truck-lite.com](http://truck-lite.com)

 <p><b>Manufacturing &amp; Quality</b></p>	 <p><b>Testing &amp; Safety</b></p>
<p>Truck-Lite’s LED forward lighting is built using premium materials and backed by industry-leading warranties.</p> <p>Designed to last the life of your vehicle, Truck-Lite’s solid-state construction and sealed circuitry mean that you can depend on your lights to withstand shock, vibration, moisture and debris.</p>	<p>All Truck-Lite forward lighting is subjected to rigorous environmental, electrical and mechanical testing before they are validated and released to the market.</p> <p>All Truck-Lite forward lighting conforms with DOT, FMVSS-108 and CMVSS-108 requirements when properly mounted.</p>
 <p><b>Performance &amp; Maintenance</b></p>	 <p><b>Customer Support</b></p>
<ul style="list-style-type: none"> <li>• True-to-life light color output</li> <li>• Lower energy consumption</li> <li>• Highly controlled beam patterns</li> <li>• Impact-resistant, non-yellowing lenses and rugged housing protect against damage from even the toughest applications</li> <li>• Plug-and-play, drop-in replacements</li> <li>• 30x the lifespan of halogen lights</li> </ul>	<p><b>Customer Service</b>                  (800) 562-5012                  customerservice@truck-lite.com</p> <p><b>Technical Support</b>                  (888) 562-5012                  tltech@truck-lite.com</p> <p><b>Forward Lighting Warranties</b></p>   
<p>(800) 562-5012   truck-lite.com</p>	

# HEADLIGHT, LED, 4" X 6"



**LOW BEAM**



**HIGH BEAM**

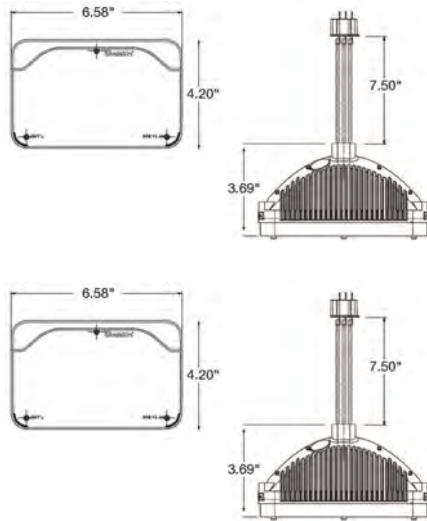

- Best-in-class beam pattern
- Excellent option for light, medium and heavy-duty trucks, off-road and agricultural vehicles, classic cars and more
- Metalized reflector optics provide a lighting experience that's smooth and clean across the driving surface
- When properly mounted, exceeds FMVSS-108 and CMVSS-108 DOT requirements for low beam
- Provides a brighter, crisper and whiter light output that is closer to the color temperature of daylight
- Dramatically improves light projection distance and overall visibility
- Durability of LEDs provides a solid-state, bulb-free headlight design that's impervious to damage from shock and vibration
- Durable housing and non-yellowing, hard-coated polycarbonate lens offer optimum protection against damage from impact, roadside debris and other hazards
- Advanced circuitry protects against voltage spikes
- Low beam is a drop-in replacement for 2A1, 4652, H4652, H4656, H4662, H4739, and H5062 headlight designs
- Uses standard H4, 3-blade wiring connector
- Up to 50x longer life than halogen technology

**LOW BEAM**

Part Number	Lamp Connection	Plug Side 1	Plug Side 2	Volts	Current Major/Minor	Diodes	Lens Material	Housing Material	Beam Pattern
27640C	Hardwired	Hardwired	H4 Connector/Stripped End	12 24	2.7/1.52	2	PC	Aluminum	High Low

**HIGH BEAM**

Part Number	Lamp Connection	Plug Side 1	Plug Side 2	Volts	Current Major/Minor	Diodes	Lens Material	Housing Material	Beam Pattern
27645C	Hardwired	Hardwired	H4 Connector/Stripped End	12 24	2.7/1.52	2	PC	Aluminum	High Low



## HEADLIGHT, LED, 5" X 7", COMPLEX REFLECTOR

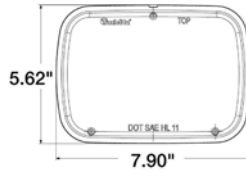
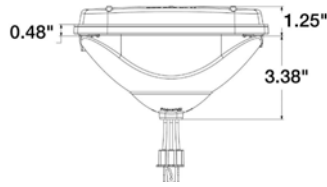

- When properly mounted, the lamp is designed to conform to the requirements listed in the Department of Transportation (DOT), FMVSS-108 and Transport Canada (TC), CMVSS-108
- Headlights marked with the DOT symbol are street-legal
- Excellent option for light, medium and heavy-duty trucks, off-road vehicles, classic cars, motorcycles and more
- Metalized reflector optics provide a lighting experience that is smooth and clean across the driving surface
- Provides a brighter, crisper and whiter light output, closer to the color temperature of daylight, dramatically improving light projection distance and overall visibility
- Durability and dependability of LED lighting provides a solid-state, bulb-free headlight design that impervious to damage from shock and vibration
- Military-grade, die-cast aluminum housing and non-yellowing, polycarbonate lens offer optimum protection against damage from impact, roadside debris and other hazards
- Electronics are sealed in epoxy to resist from damage caused by corrosion or moisture
- Advanced circuitry protects against voltage spikes up to 600V
- Drop-in replacement for #6052, 6053, H6054, and HD6054 headlight designs
- Uses standard H4, 3-blade wiring connector

Part Number	Lamp Connection	Plug Side 1	Plug Side 2	Volts	Current Major/Minor	Diodes	Lens Material	Housing Material	Beam Pattern
27450C	Hardwired	Hardwired	H4 Connector	12 24	2.95/1.45	2	PC	E-Coat Aluminum	High/Low

## RECOMMENDED ACCESSORIES



- Connects Truck-Lite's LED Headlight to a vehicle requiring a H13 connection

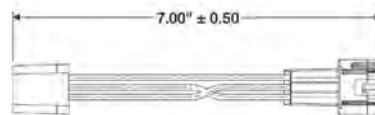

96630 - H4 to H13 adapter



- Compatible with 2007-2013 Jeep JK models
- The anti-flicker adaptor eliminates headlight flicker in 2007-2017 Jeeps and regular JK models utilizing PWM electrical systems
- A limited number of Jeep JK users may see a flicker as a result of the PWM electrical system used on these vehicle models
- This adapter will store power during on-time, and deliver power during off-time, allowing the lamp to receive consistent energy delivery
- Made to withstand rugged terrain
- Electronics are sealed in epoxy to resist damage caused by corrosion or moisture

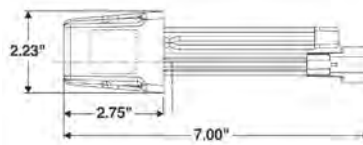

96830 - PWM pigtail with H4 to H13 adapter

# HEADLIGHT, LED, 7", COMPLEX REFLECTOR



- When properly mounted, the lamp is designed to conform to the requirements listed in the Department of Transportation (DOT), FMVSS-108 and Transport Canada (TC), CMVSS-108
- Headlights marked with the DOT symbol are street-legal
- Excellent option for light, medium and heavy-duty trucks, off-road vehicles, classic cars, motorcycles and more
- Metalized reflector optics provide a lighting experience that is smooth and clean across the driving surface
- Provides a brighter, crisper and whiter light output, closer to the color temperature of daylight, dramatically improving light projection distance and overall visibility
- Durability and dependability of LED lighting provides a solid-state, bulb-free headlight design that impervious to damage from shock and vibration
- Military-grade, die-cast aluminum housing and non-yellowing, polycarbonate lens offer optimum protection against damage from impact, roadside debris and other hazards
- Electronics are sealed in epoxy to resist damage caused by corrosion or moisture
- Advanced circuitry protects against voltage spikes up to 600V
- Drop-in replacement for #6014, 6015, 6016, H6024 and Par 56 headlight designs
- Uses standard H4, 3-blade wiring connector

Part Number	Lamp Connection	Plug Side 1	Plug Side 2	Volts	Current Major/Minor	Diodes	Lens Material	Housing Material	Beam Pattern
27270C	Hardwired	Hardwired	H4 Connector	12 24	2.95/1.45	2	PC	E-Coat Aluminum	High Low

## RECOMMENDED ACCESSORIES



- Connects Truck-Lite's LED Headlight to a vehicle requiring a H13 connection.



96630 - H4 to H13 adapter

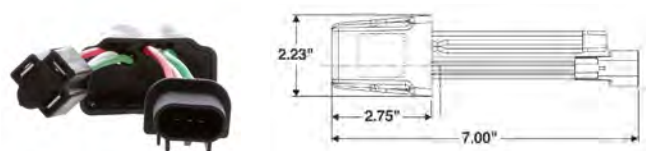

- Compatible with 2007-2013 Jeep JK models
- The anti-flicker adaptor eliminates headlight flicker in 2007-2017 Jeeps and regular JK models utilizing PWM electrical systems
- A limited number of Jeep JK users may see a flicker as a result of the PWM electrical system used on these vehicle models
- This adapter will store power during on-time, and deliver power during off-time, allowing the lamp to receive consistent energy delivery
- Made to withstand rugged terrain
- Electronics are sealed in epoxy to resist damage caused by corrosion or moisture



96830 - PWM pigtail with H4 to H13 adapter

## HEADLIGHT, LED, 7", HEATED LENS

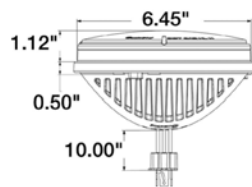

- World's first heated lens LED headlight heats constantly under 10°C / 50°F
- When properly mounted, is designed to conform to the requirements listed in the DOT FMVSS-108 and the TC CMVSS-108. The DOT symbol on the headlight signifies that it is street-legal
- Unique heat pattern is designed to prevent ice, slush and snow buildup on the lens
- Excellent option for light, medium and heavy-duty trucks and off-road vehicles that are frequently exposed to extreme weather conditions
- Metalized reflector optics provide a lighting experience that is smooth and clean across the driving surface
- Provides a brighter, crisper and whiter light output, closer to the color temperature of daylight, dramatically improving light projection distance and overall visibility
- Durability and dependability of LED lighting provides a solid-state, bulb-free headlight design that is impervious to damage from shock and vibration
- Military-grade, die-cast aluminum housing and non-yellowing, polycarbonate heated lens offer optimum protection against damage from impact, roadside debris and other hazards
- Electronics are sealed in epoxy to resist damage caused by corrosion or moisture
- Advanced circuitry protects against voltage spikes up to 600V
- Drop-in replacement for #6014, 6015, 6016, H6024 and Par 56 headlight designs
- Uses standard H4, 3-blade wiring connector

Part Number	Lamp Connection	Plug Side 1	Plug Side 2	Volts	Current Major/Minor	Diodes	Lens Material	Housing Material	Beam Pattern
27275C	Hardwired	Hardwired	H4 Connector	12 24	3.85/2.2	2	PC	E-Coat Aluminum	High Low

## RECOMMENDED ACCESSORIES

- Connects Truck-Lite's LED Headlight to a vehicle requiring a H13 connection.

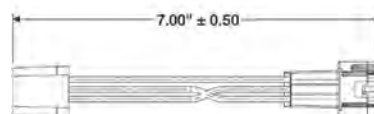

96630 - H4 to H13 adapter

- Compatible with 2007-2013 Jeep JK models
- The anti-flicker adaptor eliminates headlight flicker in 2007-2017 Jeeps and regular JK models utilizing PWM electrical systems
- A limited number of Jeep JK users may see a flicker as a result of the PWM electrical system used on these vehicle models
- This adapter will store power during on-time, and deliver power during off-time, allowing the lamp to receive consistent energy delivery
- Made to withstand rugged terrain
- Electronics are sealed in epoxy to resist damage caused by corrosion or moisture

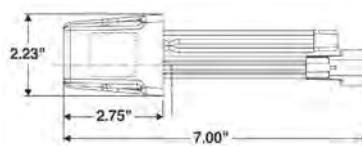

96830 - PWM pigtail with H4 to H13 adapter

# HEADLIGHT, LED, ECE, 7" & 5"X 7"

- ECE and ROHS compliant
- LED sealed beam technology with polycarbonate lens and sealed electronics
- Up to 50x longer life than halogen headlights, lowering lifecycle costs
- Perfect for medium/heavy-duty trucks, off-road vehicles, automotive, motorcycles, military applications and more
- Provides a brighter, crisper and whiter light output, closer to the color temperature of daylight, dramatically improving light projection distance and overall visibility
- Available in left hand traffic and right hand traffic versions
- Includes built-in position lamp with optional wiring
- Improved roadside coverage and highly controlled beam patterns, offering glare protection to oncoming traffic
- Dipped/passing beam and main/driving beam functionality
- Ultra-bright output for maximum night visibility
- H4, 3-blade connector system



## 7" RIGHT HAND TRAFFIC

Part Number	Lamp Connection	Plug Side 1	Plug Side 2	Volts	Current Major/Minor	Diodes	Lens Material	Housing Material	Beam Pattern
27290C	Hardwired	Hardwired	H4 Connector/Stripped End	12 24	2.7/1.52	2	PC	E-Coat Aluminum	High Low

## 7" LEFT HAND TRAFFIC

Part Number	Lamp Connection	Plug Side 1	Plug Side 2	Volts	Current Major/Minor	Diodes	Lens Material	Housing Material	Beam Pattern
27291C	Hardwired	Hardwired	H4 Connector/Stripped End	12 24	2.7/1.52	2	PC	E-Coat Aluminum	High Low



## 5"X 7" RIGHT HAND TRAFFIC

Part Number	Lamp Connection	Plug Side 1	Plug Side 2	Volts	Current Major/Minor	Diodes	Lens Material	Housing Material	Beam Pattern
27490C	Hardwired	Hardwired	H4 Connector/Stripped End	12 24	2.29/1.22	2	PC	Aluminum	High Low

## 5"X 7" LEFT HAND TRAFFIC

Part Number	Lamp Connection	Plug Side 1	Plug Side 2	Volts	Current Major/Minor	Diodes	Lens Material	Housing Material	Beam Pattern
27491C	Hardwired	Hardwired	H4 Connector/Stripped End	12 24	2.29/1.22	2	PC	Aluminum	High Low

## HEADLIGHT, HALOGEN, 4" X 6"



- Exceeds DOT minimum requirements by an average of 300% low beam and 225% high beam
- Mechanical aim
- Review for appropriate bucket fit for installing
- Retrofits ANSI #H4656
- Adapter #95846 may be needed to retrofit, included with kit
- Not recommended for certain buckets on Freightliner, Kenworth or Western Star Trucks

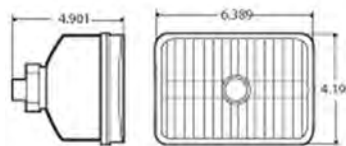

Part Number	Lamp Connection	Plug Side 1	Plug Side 2	Volts	Current Major/Minor	Diodes	Lens Material	Housing Material	Beam Pattern
27010	H5 Connector	No Plug	No Plug	12	5.08/4.3	1	Glass	Die-Cast Aluminum	High Low

HALOGEN

4 IN X 6 IN HEADLIGHT

## HEADLIGHT, HALOGEN, 5" X 7"



- Exceeds DOT minimum requirements by an average of 300% and 225% high beam
- Mechanical aim
- Review for appropriate bucket fit for installing
- Retrofits ANSI #6052, 6053, H6054, and HP6054

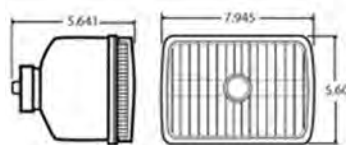

Part Number	Lamp Connection	Plug Side 1	Plug Side 2	Volts	Current Major/Minor	Diodes	Lens Material	Housing Material	Beam Pattern
27009	H4 Connector	No Plug	No Plug	12	4.69/4.3	1	Glass	Die-Cast Aluminum	High Low

### LIGHT WITH DISPLAY PACKAGING

Part Number	Lamp Connection	Plug Side 1	Plug Side 2	Volts	Current Major/Minor	Diodes	Lens Material	Housing Material	Beam Pattern
27009-1	H4 Connector	No Plug	No Plug	12	4.69/4.3	1	Glass	Die-Cast Aluminum	High Low

HALOGEN

5 IN X 7 IN HEADLIGHT

## HEADLIGHT, HALOGEN, 7"

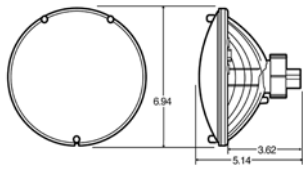

- Mechanical aim
- Polycarbonate lens provides up to 30x greater impact resistance than glass
- Easy-to-remove bulb changes out through the back of the lamp
- Bulb connector uses seal around bulb base to create weatherproof construction, preventing corrosion
- Review for appropriate bucket fit before installing



Part Number	Lamp Connection	Plug Side 1	Plug Side 2	Volts	Current Major/Minor	Diodes	Lens Material	Housing Material	Beam Pattern
27004	H4 Connector	No Plug	No Plug	12	5.1/4.3	1	PC	BMC	High Low

## HEADLIGHT, HALOGEN, 7"

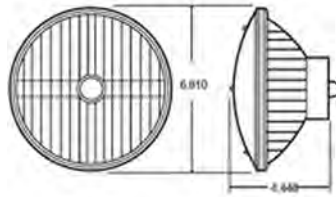

- Exceeds DOT minimum requirements by an average of 300% low beam and 225% high beam
- Mechanical aim
- Review for appropriate bucket fit for installing
- Retrofits ANSI #6014, 6015, 6016, and H6024



Part Number	Lamp Connection	Plug Side 1	Plug Side 2	Volts	Current Major/Minor	Diodes	Lens Material	Housing Material	Beam Pattern
27012	H4 Connector	No Plug	No Plug	12	4.69/4.3	1	Glass	Aluminum	High Low

### LIGHT WITH DISPLAY PACKAGING

Part Number	Lamp Connection	Plug Side 1	Plug Side 2	Volts	Current Major/Minor	Diodes	Lens Material	Housing Material	Beam Pattern
27012-1	H4 Connector	No Plug	No Plug	12	4.69/4.3	1	Glass	Aluminum	High Low

# Looking for even more product information?

Visit [truck-lite.com](http://truck-lite.com)



**Powerful Search  
Function**



**360° Product  
Images**



**Easy-To-Find  
Replacement  
Parts**

## AUXILIARY LIGHT, LED, 4", GROMMET MOUNT

LED

FOG LIGHT



- Provides a clean, streamlined look when installed along with Truck-Lite 27270C LED Headlight
- Pure white light output is closer to the color temperature of daylight, dramatically improving light projection distance and overall visibility with a bright, crisp output
- Complex reflector design optimizes and evenly distributed light for the best visibility pattern
- LEDs are bulb-free, and offer a solid-state design, encapsulated in hardened epoxy, to resist damage caused by shock and vibration, offering as much as 50x longer life than comparable incandescent lamps
- Solid-state LED design does not use a filament or bulb tube, and is unaffected by rigorous shock and vibration
- Die-cast aluminum housing is corrosion and impact-resistant
- Non-yellowing, impact-resistant polycarbonate lens stays clear and protects against damage from deflecting rocks and roadside debris



Standards Met
J1306

Part Number	Lamp Connection	Plug Side 1	Plug Side 2	Volts	Current Major/Minor	Diodes	Lens Color	Mount Material	Lens Material
80275	Hardwired	Hardwired	Packard Connector 12048159	12	0.7	1	Clear		PC

LED

44 SERIES

## 44 SERIES, FOG LIGHT, LED, 4", GROMMET MOUNT

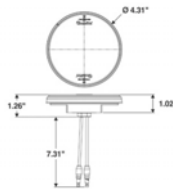

- Designed to comply with ECE Regulation 38
- Sealed polycarbonate lens and housing
- Electronics completely sealed in epoxy to resist moisture and corrosion
- Voltage range: OmniVolt 10V to 30V



Part Number	Lamp Connection	Plug Side 1	Plug Side 2	Volts	Current Major/Minor	Diodes	Lens Color	Mount Material	Lens Material
44931R	Hardwired	Hardwired	.180 Bullet	12 24	0.71/0.13	2	Red		PC



## 45 SERIES, REAR FOG LIGHT, LED, 3"X 5", GROMMET MOUNT



- Direct pin-to-circuit board solders assure vibration resistant contacts
- ECE-approved for rear position/stop direction indicator and rear fog functions
- Electronics completely sealed in epoxy to resist corrosion and moisture
- Lamps are hardwired with standard .180 molded bullet connectors
- Module receptacle wires with ring terminals available for retrofitting LED lamps to existing modules
- OmniVolt universal lighting products address increasing vehicle power demands by operating equally in electrical systems that range from 10 to 30 volts
- Sonically sealed lens and housing

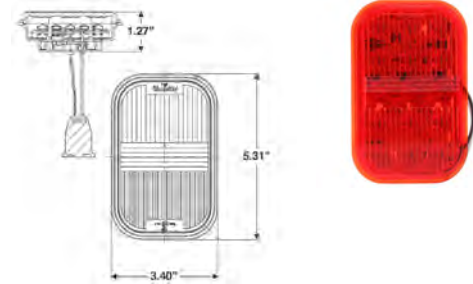

Part Number	Lamp Connection	Plug Side 1	Plug Side 2	Volts	Current Major/Minor	Diodes	Lens Color	Mount Material	Lens Material
45931R	Hardwired	Hardwired	.180 Bullet	12 24	0.24	19	Red	Red	PC
45933R	Hardwired	Hardwired	PL-2	12 24	0.24	19	Red	Red	PC

## 45 SERIES, REAR FOG LIGHT, LED, 3"X 5", GROMMET MOUNT, KIT



- OmniVolt universal lighting products address increasing vehicle power demands by operating equally in electrical systems that range from 10 to 30 volts
- Lamps are hardwired with standard .180 molded bullet connectors
- Module receptacle wires with ring terminals available for retrofitting LED lamps to existing modules
- Direct pin-to-circuit board solders assure vibration resistant contacts
- Electronics completely sealed in epoxy to resist corrosion and moisture
- Low current draw, leaving more power for other vehicle requirements
- Sonically sealed lens and housing
- LEDs are less susceptible to shock and vibration
- Approved to comply with ECE regulations for Rear position/stop, direction indicator and rear fog functions



Part Number	Lamp Connection	Plug Side 1	Plug Side 2	Volts	Current Major/Minor	Diodes	Lens Color	Mount Material	Lens Material	Kit Includes
45041R	Hardwired	Hardwired	.180 Bullet	12 24	0.24	19	Red	PVC	PC	45931R light, 45700 grommet



Introducing LED fog light kits for Class 8 vehicles including the Freightliner Cascadia, Volvo VN, International ProStar and Kenworth T680



## RIGID INDUSTRIES, D-SERIES, FOG LIGHT, LED, 3"X 3", BRACKET MOUNT, KIT, FREIGHTLINER



- Designed as a direct replacement for 2007-2016 Freightliner Cascadia fog lights
- Waterproof H11 Deutsch adapter plugs directly into factory harness
- SAE J583 compliant fog lights project high-intensity, crisp light
- Pure white light output is closer to the color temperature of daylight, dramatically improving overall visibility
- Built as a low profile, solid state design
- Durable die-cast housing and polycarbonate lens offer a robust package to combat damage caused by shock and vibration
- Low power draw
- Lifespan up to 50,000+ hours

### Standards Met

F



Part Number	Lamp Connection	Plug Side 1	Plug Side 2	Volts	Current	Diodes	Lens Color	Mount Material	Lens Material
84760	Hardwired	Hardwired	Deutsch Connector	12 24 36	2.29	4	Clear	Steel	PC

## RIGID INDUSTRIES, D-SERIES, FOG LIGHT, LED, 3"X 3", BRACKET MOUNT, KIT, VOLVO



- Designed as a direct replacement for 20013-2017 Volvo® VN® fog lights
- Waterproof H11 to Deutsch adapter plugs directly into factory harness
- SAE J583 compliant fog lights project high-intensity, crisp light
- Pure white light output is closer to the color temperature of daylight, dramatically improving overall visibility
- Built as a low-profile, solid-state design
- Durable die-cast housing and polycarbonate lens offer a robust package to combat damage caused by shock and vibration
- Low power draw
- Lifespan up to 50,000+ hours

### Standards Met

F



Part Number	Lamp Connection	Plug Side 1	Plug Side 2	Volts	Current	Diodes	Lens Color	Mount Material	Lens Material
84780	Hardwired	Hardwired	Deutsch Connector	12 24 36	1.5	4	Clear	Steel	PC

## RIGID INDUSTRIES, D-SERIES, FOG LIGHT, LED, 3"X 3", BRACKET MOUNT, KIT, INTERNATIONAL



- Designed as a direct replacement for 2008-2017 International® ProStar® fog lights
- Waterproof H11 to Deutsch adapter plugs directly into factory harness
- SAE J583 compliant fog lights project high-intensity, crisp light
- Pure white light output is closer to the color temperature of daylight, dramatically improving overall visibility
- Built as a low-profile, solid-state design
- Durable die-cast housing and polycarbonate lens offer a robust package to combat damage caused by shock and vibration
- Low power draw
- Lifespan up to 50,000+ hours

### Standards Met

F



Part Number	Lamp Connection	Plug Side 1	Plug Side 2	Volts	Current	Diodes	Lens Color	Mount Material	Lens Material
84770	Hardwired	Hardwired	Deutsch Connector	12 24 36	1.5	4	Clear	Steel	PC

## RIGID INDUSTRIES, D-SERIES, FOG LIGHT, LED, 3"X 3", BRACKET MOUNT, KIT, KENWORTH



### Standards Met

F

- Designed as a direct replacement for 20013-2017 Kenworth® T680® fog lights
- Waterproof H11 to Deutsch adapter plugs directly into factory harness
- SAE J583 compliant fog lights project high-intensity, crisp light
- Pure white light output is closer to the color temperature of daylight, dramatically improving overall visibility
- Built as a low-profile, solid-state design
- Durable die-cast housing and polycarbonate lens offer a robust package to combat damage caused by shock and vibration
- Low power draw
- Lifespan up to 50,000+ hours



Part Number	Lamp Connection	Plug Side 1	Plug Side 2	Volts	Current	Diodes	Lens Color	Mount Material	Lens Material
84761	Hardwired	Hardwired	Deutsch Connector	12 24 36	1.5	4	Clear	Steel	PC



### Standards Met

F

- Designed as an aftermarket fog light kit for D-Series Universal fog lights
- Full XL harness with switch included
- SAE J583 compliant fog lights project high-intensity, crisp light
- Pure white light output is closer to the color temperature of daylight, dramatically improving overall visibility
- Built as a low-profile, solid-state design
- Durable die-cast housing and polycarbonate lens offer a robust package to combat damage caused by shock and vibration
- Low power draw
- Lifespan up to 50,000+ hours



Part Number	Lamp Connection	Plug Side 1	Plug Side 2	Volts	Current	Diodes	Lens Color	Mount Material	Lens Material
84764	Hardwired	Hardwired	Deutsch Connector	12 24 36	1.5	4	Clear	Steel	PC

## RIGID INDUSTRIES, E-SERIES, FOG LIGHT, LED, 6", BRACKET MOUNT, KIT



### Standards Met

F

- Designed as a Universal aftermarket LED auxiliary highbeam kit using E-Series lights
- Full XL harness with switch included
- SAE J583 compliant fog lights project high-intensity, crisp light
- Pure white light output is closer to the color temperature of daylight, dramatically improving overall visibility
- Built as a low-profile, solid-state design
- Durable die-cast housing and polycarbonate lens offer a robust package to combat damage caused by shock and vibration
- Low power draw
- Lifespan up to 50,000+ hours



Part Number	Lamp Connection	Plug Side 1	Plug Side 2	Volts	Current	Diodes	Lens Color	Mount Material	Lens Material
84720	Deutsch Connector	Deutsch Connector	Ring Terminal	12 24 36	1.5	12	Clear	Steel	PC

LED

RIGID FOG LIGHT

LED

RIGID FOG LIGHT

LED

RIGID FOG LIGHT

## RIGID INDUSTRIES, SR-SERIES, AUXILIARY HIGH BEAM, LED, 6", BRACKET MOUNT, KIT



- Designed as a Universal aftermarket LED fog light kit using SR-Series lights
- Full XL harness with switch included
- SAE J583 compliant fog lights project high-intensity, crisp light
- Pure white light output is closer to the color temperature of daylight, dramatically improving overall visibility
- Built as a low-profile, solid-state design
- Durable die-cast housing and polycarbonate lens offer a robust package to combat damage caused by shock and vibration
- Low power draw
- Lifespan up to 50,000+ hours

Standards Met

F



Part Number	Lamp Connection	Plug Side 1	Plug Side 2	Volts	Current Major/Minor	Diodes	Lens Color	Mount Material	Lens Material
84740	Deutsch Connector	Deutsch Connector	Ring Terminal	12 24 36	2.29	6	Clear	Steel	PC

**Truck-Lite**  
by **RIGID**



## REPLACEMENT FOG LIGHT, INCANDESCENT, 4", GROMMET MOUNT



- Heavy gauge steel housing is powder-coated in black epoxy.
- Includes mounting hardware.
- Fluted lens disperses light evenly
- Mounts on one 5/16"-18 stud



Part Number	Lamp Connection	Plug Side 1	Plug Side 2	Volts	Current Major/Minor	Diodes	Lens Color	Lens Material
80201	Two Screw Terminal	No Plug	No Plug	12	2.7	1	Yellow	Glass

## REPLACEMENT FOG LIGHT, INCANDESCENT, 5", 1 STUD MOUNT, KIT



- Heavy-gauge steel housing is powder-coated in black epoxy
- Includes mounting hardware
- Fluted lens disperses light evenly
- Mounts on one 5/16"-18 stud



Part Number	Lamp Connection	Plug Side 1	Plug Side 2	Volts	Current Major/Minor	Diodes	Lens Color	Mount Material	Lens Material	Replacement Parts
80368	Hardwired	Hardwired	Blunt Cut	12	2.73	1	Yellow	Steel	Glass	88021 light, 95910 hardware

## SIGNAL-STAT, FOG LIGHT, INCANDESCENT, 6", 1 STUD MOUNT, KIT

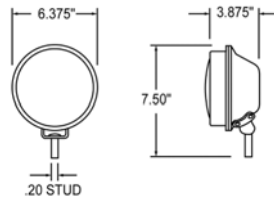

- Rugged, all-purpose lamp
- Screw-on bulb connections for positive contact and easy bulb replacement
- Single wire-stud ground
- Weatherproof rubber shell for extended bulb life
- Shell remains flexible from -40°F to 125°F
- Housing available separately
- 1/2" dia. adjustable ball stud
- Replaces Truck-Lite 80384



Part Number	Lamp Connection	Plug Side 1	Plug Side 2	Volts	Current Major/Minor	Diodes	Lens Color	Mount Material	Lens Material	Replacement Parts
631W	Hardwired	Hardwired	Stripped End	12	2.73	1	Clear	Steel	Glass	630H housing

# SIGNAL-STAT, DRIVING LIGHT, INCANDESCENT, 3" X 5", 1 STUD MOUNT



- Rugged molded PVC housing will not break or weather, remaining flexible from -40°F to 120°F
- Advanced 55-watt H3 bulb design eliminates the need for expensive sealed-beam replacement
- Precision optics
- Adjustable bracket with 5/16" stud

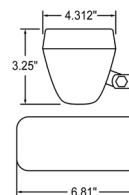

Part Number	Lamp Connection	Plug Side 1	Plug Side 2	Volts	Current Major/Minor	Diodes	Lens Color	Mount Material	Lens Material
613W	Hardwired	Hardwired	Stripped End/ Blade Terminal	12	4.5	1	Clear	Steel	Glass

INCANDESCENT

DRIVING LIGHT

# FOG LIGHT, HALOGEN, 3" X 5", 1 STUD MOUNT, KIT



- Features computer-designed optics and a vacuum-metalized steel reflector
- Simple bulb replacement through front of lamp
- Kit contains two lamps, mounting hardware, wiring kit with switch, fuse and installation instructions
- Compact design fits bumpers and spoilers for a low-profile look
- Flexible designs allows mounting above or below bumper
- Ideal for many light and recreational vehicles
- Meets or exceeds DOT/SAE and ECE standards

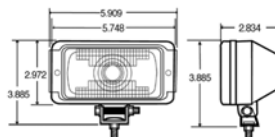

Standards Met
J583

Part Number	Lamp Connection	Plug Side 1	Plug Side 2	Volts	Current Major/Minor	Diodes	Lens Color	Mount Material	Lens Material	Kit Includes
80526	Hardwired	Hardwired	.180 Bullet	12	4.5	1	Clear	Steel	Glass	80579 light, 80603 cover, 80571 bulb, 192 relay
80525	Hardwired	Hardwired	.180 Bullet	12	4.5	1	Clear	Steel	Glass	80578 light, 80603 cover, 80571 bulb, 192 relay

HALOGEN

FOG LIGHT

# REPLACEMENT FOG LIGHT, HALOGEN, 3" X 5", 1 STUD MOUNT



Part Number	Lamp Connection	Plug Side 1	Plug Side 2	Volts	Current Major/Minor	Diodes	Lens Color	Lens Material
80208	Two Right Angle Lugs	No Plug	No Plug	12	4.2	1	Clear	Glass

HALOGEN

FOG LIGHT

## SIGNAL-STAT, FOG LIGHT, HALOGEN, 3"X 5", 1 STUD MOUNT

HALOGEN

FOG LIGHT

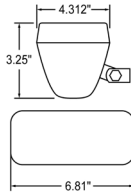

- Rugged molded PVC housing will not break or weather, remaining flexible from -40°F to 120°F
- Advanced 55-watt H3 bulb design eliminates the need for expensive sealed-beam replacement
- Precision optics
- Adjustable bracket with 5/16" stud



Part Number	Lamp Connection	Plug Side 1	Plug Side 2	Volts	Current Major/Minor	Diodes	Lens Color	Mount Material	Lens Material	Replacement Parts
612W	Hardwired	Hardwired	Stripped End/ Blade Terminal	12	4.5	1	Clear	Steel	Glass	80208 light, 95910 hardware, 9789 housing

## FOG LIGHT, HALOGEN, 3"X 6", 1 STUD MOUNT, KIT

Standards Met

J583

HALOGEN

FOG LIGHT

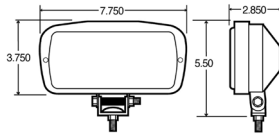

- Single-bolt, multi-position fastening system allows mounting from any angle and makes adjustments easier
- Simple replacement of bulb through front of lamp
- Meets or exceeds DOT/SAE and ECE standards
- One year manufacturer's warranty
- Ideal for use on heavy or medium-duty trucks and various off-highway vehicles



Part Number	Lamp Connection	Plug Side 1	Plug Side 2	Volts	Current Major/Minor	Diodes	Lens Color	Mount Material	Lens Material	Kit Includes
80519	Hardwired	Hardwired	Stripped End/ Ring Terminal	12	4.5	1	Yellow	Plastic	PC	80569 light, 80571 bulb, 80594 switch, 192 relay, 80593 wiring kit

## FOG LIGHT, HALOGEN, 3"X 7", 1 STUD MOUNT, KIT

Standards Met

J583

HALOGEN

FOG LIGHT

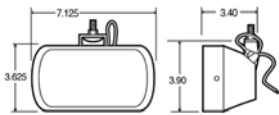

- Single-bolt, multi-position fastening system allows mounting from any angle and makes adjustments easier
- Simple replacement of bulb through front of lamp
- Meets or exceeds DOT/SAE and ECE standards
- One year manufacturer's warranty
- Ideal for use on heavy or medium-duty trucks and various off-highway vehicles



Part Number	Lamp Connection	Plug Side 1	Plug Side 2	Volts	Current Major/Minor	Diodes	Lens Color	Mount Material	Lens Material	Kit Includes
80521	Hardwired	Hardwired	Stripped End/ Ring Terminal	12	4.5	1	Clear	Plastic	Glass	80573 light, 80592 stone guard, 192 relay, 80571 bulb, 80593 wiring kit, 80594 switch
80514	Hardwired	Hardwired	Stripped End/ Ring Terminal	12	4.5	1	Clear	Plastic	PC	80568 light, 80592 stone guard, 192 relay, 80571 bulb, 80593 wiring kit, 80594 switch
80522	Hardwired	Hardwired	Stripped End/ Ring Terminal	12	4.5	1	Yellow	Plastic	Glass	80574 light, 80592 stone guard, 192 relay, 80571 bulb, 80593 wiring kit, 80594 switch



## DRIVING LIGHT, HALOGEN, 3"X 7", 1 STUD MOUNT, KIT



- Single-bolt, multi-position fastening system allows mounting from any angle and makes adjustments easier
- Simple replacement of bulb through front of lamp
- Meets or exceeds DOT/SAE and ECE standards
- One year manufacturer's warranty
- Ideal for use on heavy or medium-duty trucks and various off-highway vehicles

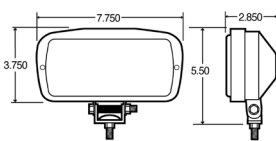

Standards Met

J583

Part Number	Lamp Connection	Plug Side 1	Plug Side 2	Volts	Current Major/Minor	Diodes	Lens Color	Mount Material	Lens Material	Kit Includes
80513	Hardwired	Hardwired	Stripped End/Ring Terminal	12	4.5	1	Clear	Plastic	PC	880567 light 80592 stone guard 192 relay 80571 bulb 80593 wiring kit 80594 switch
80520	Hardwired	Hardwired	Stripped End/Ring Terminal	12	4.5	1	Clear	Plastic	Glass	80572 light 80592 stone guard 192 relay 80571 bulb 80593 wiring kit 80594 switch

## FOG LIGHT, HALOGEN, 4"X 6", 1 STUD MOUNT



- Durable synthetic rubber housing resists corrosion
- Includes mounting hardware
- Universal mount uses one 5/16"-18 stud
- Contains one glass rectangular sealed halogen beam with two right-angle terminals
- Fluted lens disperses light evenly

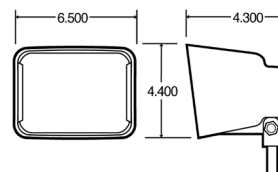

Part Number	Lamp Connection	Plug Side 1	Plug Side 2	Volts	Current Major/Minor	Diodes	Lens Color	Mount Material	Lens Material	Replacement Parts
80389	Hardwired	Hardwired	Stripped End	12	2.93	1	Clear	Steel	Glass	80208 light, 95910 hardware, 9789 housing

HALOGEN

DRIVING LIGHT

HALOGEN

FOG LIGHT

# SNOW PLOW LIGHT, LED, 7", 1 STUD MOUNT, KIT

LED  
SNOW PLOW



RIGHT-HAND SIDE

LEFT-HAND SIDE



SNOW PLOW KIT

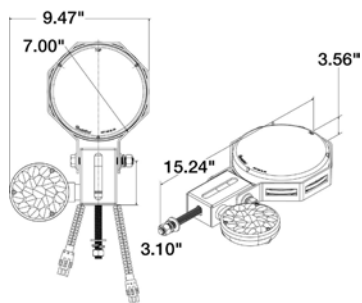

- Advanced white LED technology reduces concerns with EMI and offers substantially longer life than comparable incandescent lamps
- Lamps are hardwired with fully encapsulated electronics to protect from damage caused by corrosive elements and moisture
- Pedestal lamp (front/park/turn) features a unique LED diode array with a full pattern appearance
- Complex reflector design spreads light in a clean, more uniform pattern
- DOT-compliant LED Headlight provides a brighter, crisper and whiter light output closer to the color temperature of daylight, dramatically improving light projection distance and increasing visibility

## RIGHT HAND SIDE

Part Number	Lens Color	Lens Material	Lamp Connection	Plug Side 1	Plug Side 2	Volts	Maps Major/Minor	Mount Material	Mount Color	Housing Material
80878	Clear	PC	Hardwired	Hardwired	Packard Connector 12020829	12 24	3.6/1.8	Steel	Black	Die-Cast Aluminum

## LEFT HAND SIDE

Part Number	Lens Color	Lens Material	Lamp Connection	Plug Side 1	Plug Side 2	Volts	Maps Major/Minor	Mount Material	Mount Color	Housing Material
80879	Clear	PC	Hardwired	Hardwired	Packard Connector 12020829	12 24	3.6/1.8	Steel	Black	Die-Cast Aluminum

## SNOW PLOW KIT

Part Number	Lens Color	Lens Material	Lamp Connection	Plug Side 1	Plug Side 2	Volts	Maps Major/Minor	Mount Material	Mount Color	Housing Material
80880	Clear	PC	Hardwired	Hardwired	Packard Connector 12020829	12 24	3.6/1.8	Steel	Black	Die-Cast Aluminum

**80880 Kit Includes**  
80878 light, 80879 light, 80898 harness

# SNOW PLOW LIGHT, LED, 7", 1 STUD MOUNT, HEATED LENS, KIT

LED

SNOW PLOW



TRUCK-LITE  
1 YEAR  
WARRANTY

KIT

SNOW PLOW KIT



TRUCK-LITE  
1 YEAR  
WARRANTY

RIGHT-HAND SIDE

LEFT-HAND SIDE

- World's first heated-lens LED headlight heats constantly under 10°C/50°F
- Provides a robust, LED, solid-state solution to plowing applications in need of durable lighting that can withstand shock and vibration, replacing headlights and turn signal lights blocked by the plow assembly
- Utilizes Truck-Lite's 27275C seven inch round heated LED headlight
- Heated lens prevents snow, ice, and slush buildup
- Popular for utility/municipality use and more, as LED design draws less current, allowing more power for other vehicle requirements
- DOT-compliant LED headlight provides a brighter, crisper and whiter light output, closer to the color temperature of daylight, dramatically improving light projection distance and increasing visibility
- Advanced white LED technology reduces concerns with EMI and offers substantially longer life than comparable incandescent lights
- Complex reflector design spreads light in a clean, more uniform pattern
- Pedestal light (front/park/turn) features a unique LED diode array with a full pattern appearance
- Lights are hardwired, with fully encapsulated electronics to protect from damage caused by corrosive elements and moisture
- Corrosion-resistant, powder-coated aluminum housing dissipates heat efficiently
- Impact-resistant polycarbonate lenses protect against damage caused by debris and other hazards

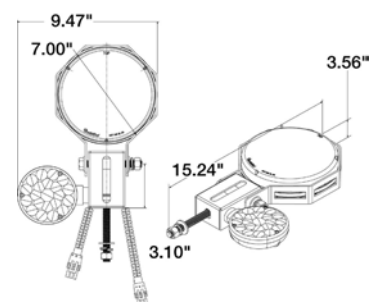

## RIGHT HAND SIDE

Part Number	Lens Color	Lens Material	Lamp Connection	Plug Side 1	Plug Side 2	Volts	Maps Major/Minor	Mount Material	Mount Color	Housing Material
80988	Clear	PC	Hardwired	Hardwired	Packard Connector 12020829/ Packard Connector 12015793	12 24	3.8 / 2.1	Steel	Black	Die-Cast Aluminum

## LEFT HAND SIDE

Part Number	Lens Color	Lens Material	Lamp Connection	Plug Side 1	Plug Side 2	Volts	Maps Major/Minor	Mount Material	Mount Color	Housing Material
80989	Clear	PC	Hardwired	Hardwired	Packard Connector 12020829/ Packard Connector 12015793	12 24	3.8 / 2.1	Steel	Black	Die-Cast Aluminum

## SNOW PLOW KIT

Part Number	Lens Color	Lens Material	Lamp Connection	Plug Side 1	Plug Side 2	Volts	Maps Major/Minor	Mount Material	Mount Color	Housing Material
80990	Clear	PC	Hardwired	Hardwired	Packard Connector 12020829/ Packard Connector 12015793	12 24	3.8 / 2.1	Steel	Black	Die-Cast Aluminum

80990 Kit Includes

80988 light, 80989 light, 80898 harness

# SNOW PLOW LIGHT, LED, 5" X 7", 1 STUD MOUNT, KIT

LED

SNOW PLOW



RIGHT-HAND SIDE



LEFT-HAND SIDE



SNOW PLOW KIT

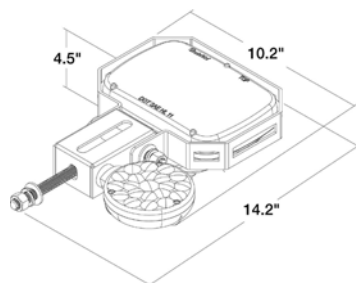

- Advanced white LED technology eliminates EMI and offers substantially longer life than comparable incandescent lamps
- Both lamps are hardwired with fully encapsulated electronics to protect from damage caused by corrosive elements and moisture
- Brighter and crisper light output improves light projection distance and increases visibility
- Complex reflector design spreads light in a clean, more uniform pattern
- Pedestal lamp features a unique LED diode array with a full pattern
- Provides a robust LED solid-state solution to applications in need of durable lighting that can withstand shock and vibration popular for utility/municipality use
- LED design draws less current and allows more power for other vehicle requirements

## LEFT HAND SIDE

Part Number	Lens Color	Lens Material	Lamp Connection	Plug Side 1	Plug Side 2	Volts	Maps Major/Minor	Mount Material	Mount Color	Housing Material
80873	Clear	PC	Hardwired	Hardwired	Packard Connector 12020829	12 24	3.6/1.8	Steel	Black	Aluminum/ Die Cast Zinc

## RIGHT HAND SIDE

Part Number	Lens Color	Lens Material	Lamp Connection	Plug Side 1	Plug Side 2	Volts	Maps Major/Minor	Mount Material	Mount Color	Housing Material
80874	Clear	PC	Hardwired	Hardwired	Packard Connector 12020829	12 24	3.6/1.8	Steel	Black	Aluminum/ Die Cast Zinc

## SNOW PLOW KIT

Part Number	Lens Color	Lens Material	Lamp Connection	Plug Side 1	Plug Side 2	Volts	Maps Major/Minor	Mount Material	Mount Color	Housing Material
80875	Clear	PC	Hardwired	Hardwired	Packard Connector 12020829	12 24	3.6/1.8	Steel	Black	Aluminum/ Die Cast Zinc

80880 Kit Includes

80873 light, 80874 light, 80898 harness

# SNOW PLOW, HALOGEN, 4"X 6", 1 STUD MOUNT, ATL-DRL, KIT

HALOGEN

SNOW PLOW



SNOW PLOW KIT



RIGHT-HAND SIDE



LEFT-HAND SIDE

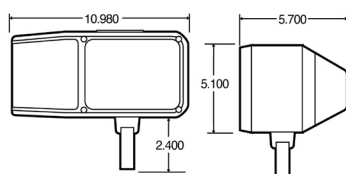

- High-impact polycarbonate and steel construction
- Features high/low beam halogen headlights and integrated park/turn lamps
- Adapts easily to vehicle equipped with daytime running light (DRL) systems
- Unique plug-in adapter design allows installation without cutting or splicing existing wiring
- Mounts on one 1/2" - 13 stud
- Normal DRL function transferred to snow plow lights
- Use matrix to determine appropriate adapter plug kit, sold separately
- Wiring system features weatherproof Packard connectors to prevent corrosion problems
- DRL kit includes a switch and a heavy-duty flasher
- Not compatible with vehicles using quad headlight or separate DRL headlights

## LEFT HAND SIDE

Part Number	Lens Color	Lens Material	Lamp Connection	Plug Side 1	Plug Side 2	Volts	Maps Major/Minor	Mount Material	Mount Color	Housing Material
80910	Clear	PC	Hardwired	Hardwired	Packard Connector 12010975	12	5.08/3.52	Steel	Black	PC

## RIGHT HAND SIDE

Part Number	Lens Color	Lens Material	Lamp Connection	Plug Side 1	Plug Side 2	Volts	Maps Major/Minor	Mount Material	Mount Color	Housing Material
80920	Clear	PC	Hardwired	Hardwired	Packard Connector 12010975	12	5.08/3.52	Steel	Black	PC

## SNOW PLOW KIT

Part Number	Lens Color	Lens Material	Lamp Connection	Plug Side 1	Plug Side 2	Volts	Maps Major/Minor	Mount Material	Mount Color	Housing Material
80900	Clear	PC	Hardwired	Hardwired	Packard Connector 12010975	12	5.08/3.52	Steel	Black	PC

### 80900 Kit Includes

80910 light, 80920 light, 80930 harness, 97224 switch, 80940 hardware

# SNOW PLOW, HALOGEN, 4"X 6" 1 STUD MOUNT, SIX POLE .180 BULLET MOLDED PLUG



RIGHT-HAND SIDE

LEFT-HAND SIDE

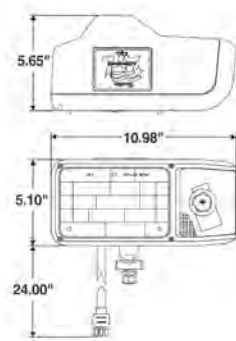

- High-impact polycarbonate and steel construction
- Features high beam/low beam halogen headlights and integrated park/turn lamps
- Lamp functions as a snow plow, all-terrain light or off-road/auxiliary light
- Mounts on one 1/2"-13 stud
- Kit also includes a switch, a grommet that protects wiring at the switch and a heavy-duty flasher
- One-piece harness runs from switch to the front of the vehicle and attaches with Scotch lock connectors

## LEFT HAND SIDE

Part Number	Lens Color	Lens Material	Lamp Connection	Plug Side 1	Plug Side 2	Volts	Maps Major/Minor	Mount Material	Mount Color	Housing Material
80810	Clear	PC	Hardwired	Hardwired	Six Pole .180 Bullet Molded Plug	12	5.08/3.52	Steel	Black	PC

## RIGHT HAND SIDE

Part Number	Lens Color	Lens Material	Lamp Connection	Plug Side 1	Plug Side 2	Volts	Maps Major/Minor	Mount Material	Mount Color	Housing Material
80820	Clear	PC	Hardwired	Hardwired	Six Pole .180 Bullet Molded Plug	12	5.08/3.52	Steel	Black	PC

# SNOW PLOW, HALOGEN, 4"X 6" 1 STUD MOUNT, SIX POLE .180 BULLET MOLDED PLUG, ECONOMY, KIT

HALOGEN

SNOW PLOW



### SNOW PLOW KIT

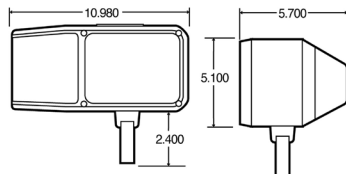

- High-impact polycarbonate and steel construction
- Features high beam/low beam halogen headlights and integrated park/turn lamps
- Mounts on one 1/2"-13 stud
- Lamp functions as snow plow, all-terrain or an off-road/auxiliary light
- Kit also includes a switch
- Two vehicle harnesses run from lamps and attach with twist-type connections

### LEFT HAND SIDE

Part Number	Lens Color	Lens Material	Lamp Connection	Plug Side 1	Plug Side 2	Volts	Maps Major/Minor	Mount Material	Mount Color	Housing Material
80860	Clear	PC	Hardwired	Hardwired	Six Pole .180 Bullet Molded Plug	12	5.08/3.52	Steel	Black	PC

### RIGHT HAND SIDE

Part Number	Lens Color	Lens Material	Lamp Connection	Plug Side 1	Plug Side 2	Volts	Maps Major/Minor	Mount Material	Mount Color	Housing Material
80870	Clear	PC	Hardwired	Hardwired	Six Pole .180 Bullet Molded Plug	12	5.08/3.52	Steel	Black	PC

### SNOW PLOW KIT

Part Number	Lens Color	Lens Material	Lamp Connection	Plug Side 1	Plug Side 2	Volts	Maps Major/Minor	Mount Material	Mount Color	Housing Material
80888	Clear	PC	Hardwired	Hardwired	Six Pole .180 Bullet Molded Plug	12	5.08/3.52	Steel	Black	PC

**80900 Kit Includes**  
 80860 light, 80870 light, 80831 harness, 80844 hardware



# SNOW PLOW, HALOGEN, 4"X 6" 1 STUD MOUNT, SIX POLE .180 BULLET MOLDED PLUG, UNIVERSAL, KIT



80800

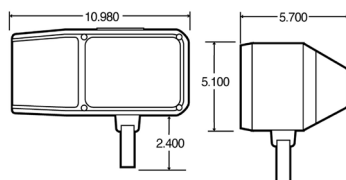

- High-impact polycarbonate and steel construction
- Features high beam/low beam halogen headlights and integrated park/turn lamps
- Lamp functions as a snow plow, all-terrain light, or off-road/auxiliary light
- Mounts on one 1/2"-13 stud
- Kit also includes a switch, a grommet that protects wiring at the switch and a heavy-duty flasher
- One-piece harness runs from switch to the front of the vehicle and attaches with Scotch lock connectors



80839

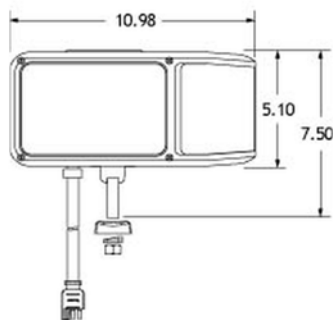

- Incorporates complex reflector technology to help reduce driver fatigue
- Increased beam pattern output and improved beam pattern formation
- High-impact polycarbonate and steel construction
- Features high beam/low beam halogen headlights and integrated park/turn lamps
- Mounts on one 1/2" - 13 stud
- Lamp functions as a snow plow lights, all-terrain, or an off-road/auxiliary lights
- Kit also includes a switch and wiring harness kit

80800

Part Number	Lens Color	Lens Material	Lamp Connection	Plug Side 1	Plug Side 2	Volts	Maps Major/Minor	Mount Material	Mount Color	Housing Material
80800	Clear	PC	Hardwired	Hardwired	Six Pole .180 Bullet Molded Plug	12	5.08/3.52	Steel	Black	PC

**80800 Kit Includes**

80810 light, 80820 light, 80830 harness, 80840 hardware

80839

Part Number	Lens Color	Lens Material	Lamp Connection	Plug Side 1	Plug Side 2	Volts	Maps Major/Minor	Mount Material	Mount Color	Housing Material
80893	Clear	Glass	Hardwired	Hardwired	Six Pole .180 Bullet Molded Plug	12	3.8/3.2	Steel	Black	PC

**80839 Kit Includes**

27010 light, 80831 harness, 80844 hardware



# SNOW PLOW, HALOGEN, 4"X 6" 1 STUD MOUNT, PACKARD CONNECTOR 12065158, UNIVERSAL, KIT

HALOGEN

SNOW PLOW



RIGHT-HAND SIDE



LEFT-HAND SIDE

SNOW PLOW KIT

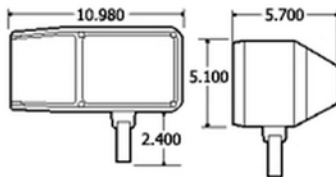

- Features weatherproof connectors
- High-impact polycarbonate and steel construction
- Features high beam/low beam halogen headlights and integrated park/turn lamps
- Mounts on one 1/2" - 13 stud
- Lamp functions as snow plow, all-terrain light, or off-road/auxiliary light
- Kit also includes a switch, a grommet that protects wiring at the switch and a heavy-duty flasher
- One-piece harness runs from switch to the front of the vehicle and attaches with Packard weather proof connectors

## LEFT HAND SIDE

Part Number	Lens Color	Lens Material	Lamp Connection	Plug Side 1	Plug Side 2	Volts	Maps Major/Minor	Mount Material	Mount Color	Housing Material
80848	Clear	PC	Hardwired	Hardwired	Packard Connector 12065158	12	5.08/3.52	Steel	Black	PC

## RIGHT HAND SIDE

Part Number	Lens Color	Lens Material	Lamp Connection	Plug Side 1	Plug Side 2	Volts	Maps Major/Minor	Mount Material	Mount Color	Housing Material
80849	Clear	PC	Hardwired	Hardwired	Packard Connector 12065158	12	5.08/3.52	Steel	Black	PC

## SNOW PLOW KIT

Part Number	Lens Color	Lens Material	Lamp Connection	Plug Side 1	Plug Side 2	Volts	Maps Major/Minor	Mount Material	Mount Color	Housing Material
80805	Clear	PC	Hardwired	Hardwired	Packard Connector 12065158	12	5.08/3.52	Steel	Black	PC

### 80900 Kit Includes

80848 light, 80849 light, 80839 harness, 80840 hardware

# WARNING & EMERGENCY

## STROBE LIGHTS

Pages 260-273

### LED

SERIES	COMMON SIZE	PAGES
30® Series	2"	260
Super 44®	4"	260-263
Super 60®	2" x 6"	264-266
4 Diode 1"	1"	267
16 Diode Self-Contained	3" x 5"	267
Surface Mount	Multiple	268-270
Grommet Mount	Multiple	270

### STROBE TUBE

SERIES	COMMON SIZE	PAGES
1in 1 Bulb	1"	270
2in x 5in 1 Bulb	2" x 5"	271
2in x 6in 1 Bulb	2" x 6"	271
3in x 5in 1 bulb	3" x 5"	271
4in 1 Bulb	4"	272
7in 1 Bulb	7"	272
Hide-A-Way Systems		273

# BEACONS

Pages 274-280

## LED

SERIES	PAGES
Class 1 High Profile	274
Class 1 Medium Profile	274-275
Class 1 Low Profile	275
Class 2 Low Profile	275-276

## HALOGEN

SERIES	PAGES
Class 1	277
Class 2	277

## GAS DISCHARGE

SERIES	PAGES
Class 1 High Profile	278
Class 1 Medium Profile	278-279
Class 1 Low Profile	279-280

# LIGHT BARS

Pages 282-285

## LED

SERIES	PAGES
Permanent Mount 4" x 36"	282
Permanent Mount 5" x 19"	282
Permanent Mount 5" x 47"	282

## INCANDESCENT

SERIES	PAGES
5" x 46"	283

## HALOGEN

SERIES	PAGES
4.5" x 16"	283
5" x 36"	284
5" x 46"	284
5" x 47"	284

## GAS DISCHARGE

SERIES	PAGES
4.5" x 16"	285
5" x 36"	285

# TRAFFIC CONTROL LIGHT BARS

Pages 286-287

SERIES	PAGES
LED	286

SERIES	PAGES
Halogen	287







# Warning & Emergency

Developed through Truck-Lite's experience in both LED design and heavy-duty warning lighting systems, these strobes and beacons offer rugged and dependable conspicuity regardless of the application.

<p><b>Mount type</b></p>	<p>Flange, Grommet, Surface, Stud, 1-Screw, 2-Screw, 4-Screw, Bracket, Magnetic, Permanent</p>
<p><b>Shapes</b></p>	<p><b>Strobe</b> Round, oval, rectangular</p> <p><b>Beacon</b> Low profile, medium profile, high profile</p>
<p><b>Classifications</b></p> <p>Before selecting any warning or safety lighting, it's important to know the legal classifications for a given application.</p>	<p><b>Class I</b> The brightest of all warning lighting, Class I lights most often appear on emergency vehicles, such as police cars, fire trucks and ambulances.</p> <p><b>Class II</b> Class II warning lights produce no more than 25% of the intensity of Class I strobes and beacons. These usually appear on utility and construction vehicles.</p> <p><b>Class III</b> Producing approximately 40% of the intensity of Class II strobes and beacons, Class III warning lights are typically used indoors, such as on a forklift.</p>

(800) 562-5012 | [truck-lite.com](http://truck-lite.com)

 <p><b>Manufacturing &amp; Quality</b></p>	 <p><b>Testing &amp; Safety</b></p>
<p>Truck-Lite's LED warning lighting is built using premium materials and backed by industry-leading warranties.</p> <p>Designed to last the life of your vehicle, Truck-Lite's solid-state construction and sealed circuitry mean that you can depend on your lights to withstand shock, vibration, moisture and debris.</p>	<p>All Truck-Lite warning and safety lighting is subjected to rigorous environmental, electrical and mechanical testing before they are validated and released to the market.</p>
 <p><b>Performance &amp; Maintenance</b></p>	 <p><b>Customer Support</b></p>
<ul style="list-style-type: none"> <li>• Lower energy consumption</li> <li>• Impact-resistant lenses and rugged housing protect against damage from even the toughest applications</li> <li>• Solid-state electronics designed for long-term dependability</li> </ul>	<div data-bbox="885 1228 957 1302"> </div> <p><b>Customer Service</b> (800) 562-5012 customerservice@truck-lite.com</p> <div data-bbox="885 1449 957 1522"> </div> <p><b>Technical Support</b> (888) 562-5012 tltech@truck-lite.com</p> <p><b>Warning &amp; Emergency Warranties</b></p> <div data-bbox="869 1774 1420 1869"> </div>
<p>(800) 562-5012   truck-lite.com</p>	

LED

30 SERIES

### 30<sup>®</sup> SERIES, LED, 3 DIODE, SELF CONTAINED, GROMMET MOUNT

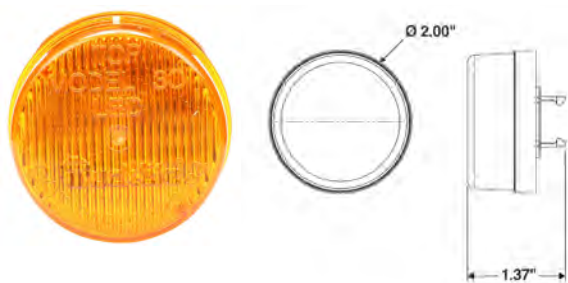

- External power pack not required.
- Features internal circuitry to create self-flashing lamp.
- Flashes when power supplied (80 FPM).
- Not for standard marker applications, for auxiliary/strobe use only.
- Uses Fit 'N Forget connector for added corrosion & moisture resistance.
- Utilized to warn operator of fault conditions.



Part Number	Lens Color	Lamp Connector	Plug Side 1	Plug Side 2	Volts	Amps
30286Y	Yellow	Fit 'N Forget M/C	No Plug	No Plug	12	0.06
30286R	Red	Fit 'N Forget M/C	No Plug	No Plug	12	0.06

LED

SUPER 44

### SUPER 44<sup>®</sup>, LED, 6 DIODE, SELF CONTAINED, GROMMET MOUNT

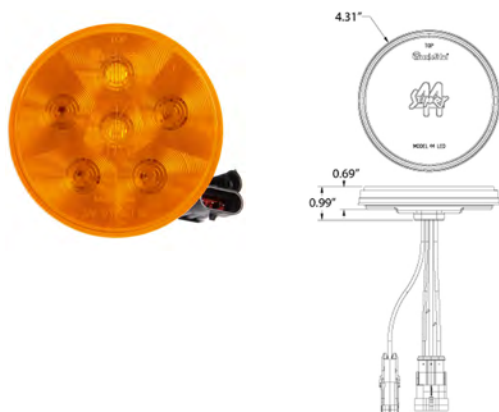

- New Super 44 Series Rear Turn Strobe lamp provides a quad flash pattern with solid-state LED technology
- Turn signal override feature momentarily overrides strobe function allowing lamps to signal for turn functions
- Lateral system allows alternating flash patterns without the need of a separate box, saving on cost and additional installation time
- Uses Truck-Lite 6-Diode round optics pattern to compliment S/T/T and B/U applications
- Fully encapsulated electronics and hard-wired design protect the lamp from corrosion and damage caused by chemicals and moisture
- New lamp design features a slim profile for mounting in areas of limited space
- Using 2 in-phase lamps or 2 out-phase lamps provide a synchronized flash, 1 in-phase lamp and 1 out-phase lamp provides alternating flash
- Features the Truck-Lite Limited Lifetime Warranty



Part Number	Lens Color	Lamp Connector	Plug Side 1	Plug Side 2	Volts	Amps	Mount Color	Warning Class	Phase
44217Y	Yellow	Hardwired	Hardwired	Packard Connector 282087/ Weather Connector 12015791	12	0.7	White	II	in-phase
44218Y	Yellow	Hardwired	Hardwired	Packard Connector 282087/ Weather Connector 12015791	12	0.7	White	II	out-phase
44110Y	Yellow	Hardwired	Hardwired	Packard Connector 282087/ Weather Connector 12015791	12	0.7	White	II	
44248Y	Yellow	Hardwired	Hardwired	Stripped End	12	0.7	White	II	in-phase
44249Y	Yellow	Hardwired	Hardwired	Stripped End	12	0.7	White	II	out-phase
44114Y	Yellow	Hardwired	Hardwired	Stripped End	12	0.7	White	II	

## LED, 42 DIODE, 4", REMOTE, GROMMET MOUNT, KIT



- LED retrofit kit for front loader waste haulers
- Features 2 LED Model 60 front, park and turn lamps and 4 LED Super 44 turn signal lamps



Part Number	Position	Lens Color	Lamp Connector	Plug Side 1	Plug Side 2	Volts	Amps	Mount Color	Kit Includes
30286Y	Front	Yellow	Fit 'N Forget S.S.	Fit 'N Forget S.S.	Straight PL-3	12	0.54	Black	44201y, 60290y, 40700 grommet, 88824 plug
30286R	Rear	Yellow	Fit 'N Forget S.S.	Fit 'N Forget S.S.	Straight PL-3	12	0.54	Black	44201y, 40700 grommet, 88824 plug, 94706 plug

## SUPER 44<sup>®</sup>, LED, 42 DIODE, SELF CONTAINED, GROMMET MOUNT



- External power pack not required
- Metalized reflector version offers more intense focused light
- Non-metalized version offers wider viewing angle
- Dual or quad flashing patterns
- Meets recommended SAE J1318 and J845 photometric specifications
- Synchronized alternating feature
- Lamp life rated at 100,000 hours
- Resistance to shock and vibration
- Fit 'N Forget S.S. adapter plug provides corrosion and moisture resistance
- Integral flange option features built-in lens



Part Number	Lens Color	Lamp Connector	Plug Side 1	Plug Side 2	Volts	Amps
44211Y	Yellow	Fit 'N Forget S.S.	No Plug	No Plug	12	0.5

## SUPER 44<sup>®</sup>, LED, 42 DIODE, SELF CONTAINED, GROMMET MOUNT, KIT



- External power pack not required
- Metalized reflector version offers more intense focused light
- Non-metalized version offers wider viewing angle
- Dual or quad flashing patterns
- Meets recommended SAE J1318 and J845 photometric specifications
- Synchronized alternating feature
- Lamp life rated at 100,000 hours
- Resistance to shock and vibration
- Fit 'N Forget™ adapter plug provides corrosion and moisture resistance
- Integral flange option features built-in lens



Part Number	Lens Color	Lamp Connector	Plug Side 1	Plug Side 2	Volts	Amps	Mount Color
44211R	Red	Fit 'N Forget S.S.	Fit 'N Forget S.S.	Female PL-2	12	0.5	Black

# SUPER 44®, LED, 42 DIODE, SELF CONTAINED, GROMMET MOUNT, METALIZED

LED

SUPER 44



- External power pack not required
- Metalized reflector version offers more intense focused light
- Non-metalized version offers wider viewing angle
- Dual or quad flashing patterns
- Meets recommended SAE J1318 and J845 photometric specifications
- Synchronized alternating feature
- Lamp life rated at 100,000 hours
- Resistance to shock and vibration
- Fit 'N Forget™ adapter plug provides corrosion and moisture resistance
- Integral flange option features built-in lens



Part Number	Lens Color	Lamp Connector	Plug Side 1	Plug Side 2	Volts	Amps
44212R	Red	Fit 'N Forget S.S.	No Plug	No Plug	12	0.5
44212Y	Yellow	Fit 'N Forget S.S.	No Plug	No Plug	12	0.5

# SUPER 44®, LED, 42 DIODE, SELF-CONTAINED, GROMMET MOUNT, KIT

LED

SUPER 44



- External power pack not required
- Metalized reflector version offers more intense focused light
- Non-metalized version offers wider viewing angle
- Dual or quad flashing patterns
- Meets recommended SAE J1318 and J845 photometric specifications
- Synchronized alternating feature
- Lamp life rated at 100,000 hours
- Resistance to shock and vibration
- Fit 'N Forget™ adapter plug provides corrosion and moisture resistance
- Integral flange option features built-in lens



Part Number	Lens Color	Lamp Connector	Plug Side 1	Plug Side 2	Volts	Amps	Mount Color	Kit Includes
44101R	Red	Fit 'N Forget S.S.	Fit 'N Forget S.S.	Stripped End/ Ring Terminal	12	0.5	Black	44211R, 40700 grommet, 95220 plug
44101Y	Yellow	Fit 'N Forget S.S.	Fit 'N Forget S.S.	Stripped End/ Ring Terminal	12	0.5	Amber	44211Y, 40700 grommet, 95220 plug

# SUPER 44®, LED, 42 DIODE, SELF-CONTAINED, METALIZED, GROMMET MOUNT, KIT

LED

SUPER 44



- External power pack not required
- Metalized reflector version offers more intense focused light
- Non-metalized version offers wider viewing angle
- Dual or quad flashing patterns
- Meets recommended SAE J1318 and J845 photometric specifications
- Synchronized alternating feature
- Lamp life rated at 100,000 hours
- Resistance to shock and vibration
- Fit 'N Forget™ adapter plug provides corrosion and moisture resistance
- Integral flange option features built-in lens



Part Number	Lens Color	Lamp Connector	Plug Side 1	Plug Side 2	Volts	Amps	Mount Color	Kit Includes
44102Y	Yellow	Fit 'N Forget S.S.	Fit 'N Forget S.S.	Stripped End/ Ring Terminal	12	0.5	Black	44212Y, 40700 grommet, 95220 plug
44102R	Red	Fit 'N Forget S.S.	Fit 'N Forget S.S.	Stripped End/ Ring Terminal	12	0.5	Black	44212R, 40700 grommet, 95220 plug



## SUPER 44<sup>®</sup>, LED, 42 DIODE, SELF CONTAINED, FLANGE MOUNT



- External power pack not required
- Metalized reflector version offers more intense focused light
- Non-metalized version offers wider viewing angle
- Dual or quad flashing patterns
- Meets recommended SAE J1318 and J845 photometric specifications
- Synchronized alternating feature
- Lamp life rated at 100,000 hours
- Resistance to shock and vibration
- Fit 'N Forget™ adapter plug provides corrosion and moisture resistance
- Integral flange option features built-in lens

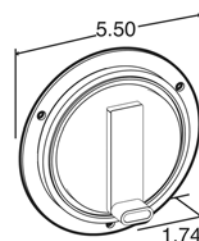

Part Number	Lens Color	Lamp Connector	Plug Side 1	Plug Side 2	Volts	Amps	Mount Color
44103R	Red	Fit 'N Forget S.S.	Fit 'N Forget S.S.	Stripped End/Ring Terminal	12	0.5	Red
44103Y	Yellow	Fit 'N Forget S.S.	Fit 'N Forget S.S.	Stripped End/Ring Terminal	12	0.5	Amber
44213R	Red	Fit 'N Forget S.S.	No Plug	No Plug	12	0.5	Black
44213Y	Yellow	Fit 'N Forget S.S.	No Plug	No Plug	12	0.5	Gray

## SUPER 44<sup>®</sup>, LED, 42 DIODE, SELF CONTAINED, METALIZED, FLANGE MOUNT



- External power pack not required
- Metalized reflector version offers more intense focused light
- Non-metalized version offers wider viewing angle
- Dual or quad flashing patterns
- Meets recommended SAE J1318 and J845 photometric specifications
- Synchronized alternating feature
- Lamp life rated at 100,000 hours
- Resistance to shock and vibration
- Fit 'N Forget™ adapter plug provides corrosion and moisture resistance
- Integral flange option features built-in lens

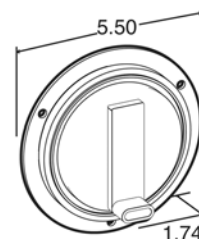

Part Number	Lens Color	Lamp Connector	Plug Side 1	Plug Side 2	Volts	Amps	Mount Color
44104R	Red	Fit 'N Forget S.S.	Fit 'N Forget S.S.	Stripped End/Ring Terminal	12	0.5	Gray
44104Y	Yellow	Fit 'N Forget S.S.	Fit 'N Forget S.S.	Stripped End/Ring Terminal	12	0.5	Gray
44214R	Red	Fit 'N Forget S.S.	No Plug	No Plug	12	0.5	Gray
44214Y	Yellow	Fit 'N Forget S.S.	No Plug	No Plug	12	0.5	Gray

## SUPER 44<sup>®</sup>, LED, 42 DIODE, SELF CONTAINED, 1 STUD MOUNT



- Durable synthetic rubber housing resists corrosion
- Includes mounting hardware
- Mounts on 5/16 - 18 stud
- External power pack or control module not required
- Meets SAE J1318 and J845 photometric specifications
- Synchronized alternating feature

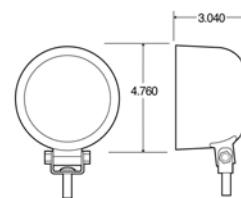

Part Number	Lens Color	Lamp Connector	Plug Side 1	Plug Side 2	Volts	Amps	Mount Color
44216R	Red	Fit 'N Forget S.S.	Fit 'N Forget S.S.	.180 Bullet/Ring Terminal	12	0.57	Black
44216Y	Yellow	Fit 'N Forget S.S.	Fit 'N Forget S.S.	.180 Bullet/Ring Terminal	12	0.57	Black

## SUPER 60<sup>®</sup>, LED, 36 DIODE, SELF CONTAINED, GROMMET MOUNT

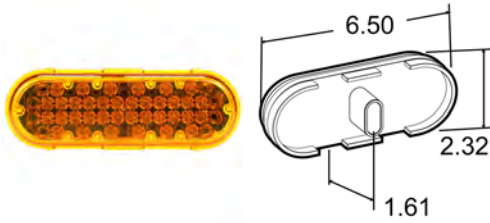

- External power pack not required
- Metalized reflector version offers more intense focused light
- Non-metalized version offers wider viewing angle
- Dual or quad flashing patterns
- Meets recommended SAE J1318 and J845 photometric specifications
- Mounts horizontally or vertically
- Lamp life rated at 100,000 hours
- Resistance to shock and vibration
- Integral flange option features built-in lens
- Fit 'N Forget™ adapter plug provides corrosion and moisture resistance
- Integral flange option features built-in lens



Part Number	Lens Color	Lamp Connector	Plug Side 1	Plug Side 2	Volts	Amps	Metalized	Warning Class
60360R	Red	Fit 'N Forget S.S.	No Plug	No Plug	12	0.5	no	II
60360Y	Yellow	Fit 'N Forget S.S.	No Plug	No Plug	12	0.5	no	II
60362R	Red	Fit 'N Forget S.S.	No Plug	No Plug	12	0.5	yes	II
60362Y	Yellow	Fit 'N Forget S.S.	No Plug	No Plug	12	0.5	yes	II

## SUPER 60<sup>®</sup>, LED, 36 DIODE, SELF-CONTAINED, GROMMET MOUNT, KIT

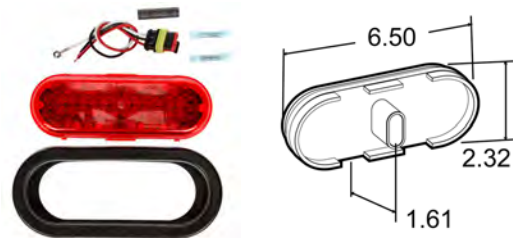

- External power pack not required
- Metalized reflector version offers more intense focused light
- Non-metalized version offers wider viewing angle
- Dual or quad flashing patterns
- Meets recommended SAE J1318 and J845 photometric specifications
- Synchronized alternating feature
- Lamp life rated at 100,000 hours
- Resistance to shock and vibration
- Fit 'N Forget™ adapter plug provides corrosion and moisture resistance
- Integral flange option features built-in lens



Part Number	Lens Color	Lamp Connector	Plug Side 1	Plug Side 2	Volts	Amps	Mount Color	Warning Class	Kit Includes
60122R	Red	Fit 'N Forget S.S.	Fit 'N Forget S.S.	Stripped End/Ring Terminal	12	0.5	Red	II	60360r, 60700 grommet, 95220 plug
60122Y	Yellow	Fit 'N Forget S.S.	Fit 'N Forget S.S.	Stripped End/Ring Terminal	12	0.5	Black	II	60360y lens, 60700 grommet, 95220 plug

## SUPER 60<sup>®</sup>, LED, 36 DIODE, SELF-CONTAINED, METALIZED GROMMET MOUNT, KIT



- External power pack not required
- Metalized reflector version offers more intense focused light
- Non-metalized version offers wider viewing angle
- Dual or quad flashing patterns
- Meets recommended SAE J1318 and J845 photometric specifications
- Mounts horizontally or vertically
- Lamp life rated at 100,000 hours
- Resistance to shock and vibration
- Integral flange option features built-in lens
- Fit 'N Forget™ adapter plug provides corrosion and moisture resistance
- Integral flange option features built-in lens



Part Number	Lens Color	Lamp Connector	Plug Side 1	Plug Side 2	Volts	Amps	Mount Color	Warning Class	Kit Includes
60120R	Red	Fit 'N Forget S.S.	Fit 'N Forget S.S.	Stripped End/Ring Terminal	12	0.5	Red	II	60362r lens, 60700 grommet, 95220 plug
60120Y	Yellow	Fit 'N Forget S.S.	Fit 'N Forget S.S.	Stripped End/Ring Terminal	12	0.5	Black	II	60362r lens, 60700 grommet, 95220 plug

## SUPER 60<sup>®</sup>, LED, 36 DIODE, SELF CONTAINED, FLANGE MOUNT



- External power pack not required
- Metalized reflector version offers more intense focused light
- Non-metalized version offers wider viewing angle
- Dual or quad flashing patterns
- Meets recommended SAE J1318 and J845 photometric specifications
- Mounts horizontally or vertically
- Lamp life rated at 100,000 hours
- Resistance to shock and vibration
- Integral flange option features built-in lens
- Fit 'N Forget™ adapter plug provides corrosion and moisture resistance
- Integral flange option features built-in lens

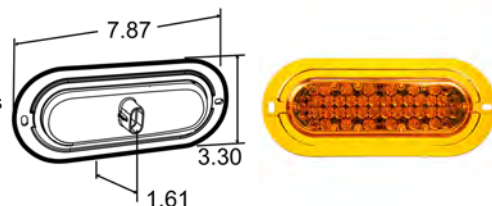

Part Number	Lens Color	Lamp Connector	Plug Side 1	Plug Side 2	Volts	Amps	Mount Color	Warning Class
60366R	Red	Fit 'N Forget S.S.	No Plug	No Plug	12	0.5	Red	II
60366Y	Yellow	Fit 'N Forget S.S.	No Plug	No Plug	12	0.5	Black	II

## SUPER 60<sup>®</sup>, LED, 36 DIODE, SELF CONTAINED, METALIZED, FLANGE MOUNT



- External power pack not required
- Metalized reflector version offers more intense focused light
- Non-metalized version offers wider viewing angle
- Dual or quad flashing patterns
- Meets recommended SAE J1318 and J845 photometric specifications
- Mounts horizontally or vertically
- Lamp life rated at 100,000 hours
- Resistance to shock and vibration
- Integral flange option features built-in lens
- Fit 'N Forget™ adapter plug provides corrosion and moisture resistance
- Integral flange option features built-in lens

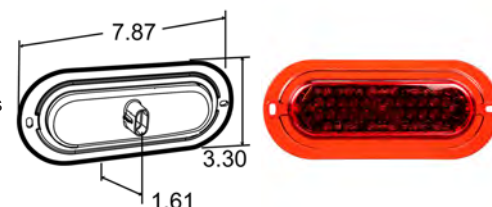

Part Number	Lens Color	Lamp Connector	Plug Side 1	Plug Side 2	Volts	Amps	Mount Color	Warning Class
60364R	Red	Fit 'N Forget S.S.	No Plug	No Plug	12	0.5	Red	II
60364Y	Yellow	Fit 'N Forget S.S.	No Plug	No Plug	12	0.5	Black	II

## SUPER 60<sup>®</sup>, LED, 36 DIODE, SELF-CONTAINED, FLANGE MOUNT, KIT

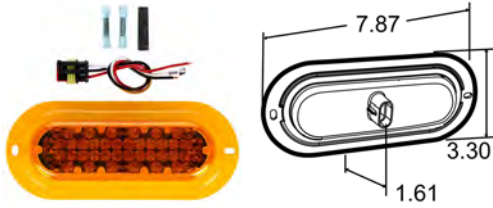

- External power pack not required
- Metalized reflector version offers more intense focused light
- Non-metalized version offers wider viewing angle
- Dual or quad flashing patterns
- Meets recommended SAE J1318 and J845 photometric specifications
- Mounts horizontally or vertically
- Lamp life rated at 100,000 hours
- Resistance to shock and vibration
- Integral flange option features built-in lens
- Fit 'N Forget™ adapter plug provides corrosion and moisture resistance
- Integral flange option features built-in lens



Part Number	Lens Color	Lamp Connector	Plug Side 1	Plug Side 2	Volts	Amps	Mount Color	Warning Class	Kit Includes
60126R	Red	Fit 'N Forget S.S.	Fit 'N Forget S.S.	Stripped End/Ring Terminal	12	0.5	Red	II	60366r lens, 95220 plug
60126Y	Yellow	Fit 'N Forget S.S.	Fit 'N Forget S.S.	Stripped End/Ring Terminal	12	0.5	Yellow	II	60366y lens, 95220 plug

## SUPER 60<sup>®</sup>, LED, 36 DIODE, SELF-CONTAINED, METALIZED FLANGE MOUNT, KIT

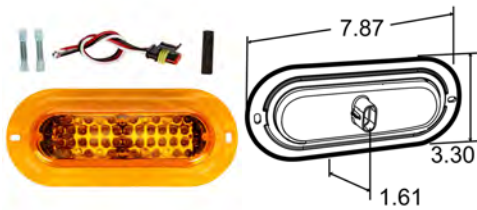

- External power pack not required
- Metalized reflector version offers more intense focused light
- Non-metalized version offers wider viewing angle
- Dual or quad flashing patterns
- Meets recommended SAE J1318 and J845 photometric specifications
- Mounts horizontally or vertically
- Lamp life rated at 100,000 hours
- Resistance to shock and vibration
- Integral flange option features built-in lens
- Fit 'N Forget™ adapter plug provides corrosion and moisture resistance
- Integral flange option features built-in lens



Part Number	Lens Color	Lamp Connector	Plug Side 1	Plug Side 2	Volts	Amps	Mount Color	Warning Class	Kit Includes
60124R	Red	Fit 'N Forget S.S.	Fit 'N Forget S.S.	Stripped End/Ring Terminal	12	0.5	Red	II	60364r lens, 95220 plug
60124Y	Yellow	Fit 'N Forget S.S.	Fit 'N Forget S.S.	Stripped End/Ring Terminal	12	0.5	Black	II	60364y lens, 95220 plug

## LED, 4 DIODE, 1", SELF CONTAINED, FLANGE MOUNT



- 25 selectable flash patterns
- Changeable colored lenses: yellow, blue and red
- Spherical LED heads are designed with diffusing optics for extremely wide-angle light output

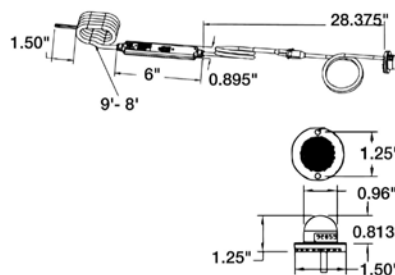

Part Number	Lens Color	Lamp Connector	Plug Side 1	Plug Side 2	Volts	Amps	Mount Color
92855	Clear	Hardwired	Hardwired	Stripped End	12 24	0.15	Silver

## LED, 16 DIODE, SELF CONTAINED, 2 SCREW



- Designed for excellent versatile perimeter lighting
- Directional warning for any type of vehicle including trash, D.O.T., wreckers and utility vehicles
- Features five selectable flash pattern per light head
- Meets SAE J1318 Class II, J845 Class 2, J595 40-degree angle when properly configured
- Potted circuitry and waterproof power supply
- Very bright signal in compact design
- Low amp draw, dual 12V or 24V
- Easy installation

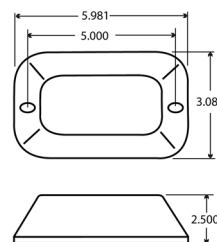

Part Number	Lens Color	Lamp Connector	Plug Side 1	Plug Side 2	Volts	Amps	Mount Color	Warning Class
92695Y	Yellow	Hardwired	Hardwired	Blade Terminal/ Stripped End Ring Terminal	12	0.2	Silver	II

## LED, 16 DIODE, SELF CONTAINED, 2 SCREW, KIT



- Designed for excellent versatile perimeter lighting
- Directional warning for any type of vehicle including trash, D.O.T., wreckers and utility vehicles
- Features five selectable flash pattern per light head
- Meets SAE J1318 Class II, J845 Class 2, J595 40-degree angle when properly configured
- Potted circuitry and waterproof power supply
- Very bright signal in compact design
- Low amp draw, dual 12V or 24V
- Easy installation

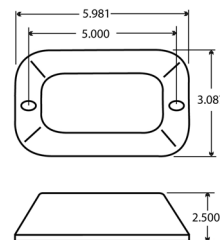

Part Number	Lens Color	Lamp Connector	Plug Side 1	Plug Side 2	Volts	Amps	Mount Color	Warning Class
92696Y	Yellow	Hardwired	Hardwired	Blade Terminal/ Stripped End Ring Terminal	12	0.2	Black	II

LED

18 DIODE

## LED, 18 DIODE, 1.5"X5", SELF CONTAINED, SURFACE MOUNT, KIT

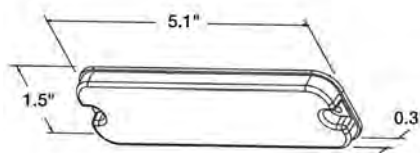

- 16 flash patterns including random
- 18 high-intensity LEDs
- Encapsulated electronics extend product life
- Synchronization capable



Part Number	Lens Color	Lamp Connector	Plug Side 1	Plug Side 2	Volts	Amps	Mount Color	Warning Class
92872R	Clear Red	Hardwired	Hardwired	Stripped End	12	0.5	Clear	I
92872Y	Clear Yellow	Hardwired	Hardwired	Stripped End	12	0.5	Clear	I
92872B	Clear Blue	Hardwired	Hardwired	Stripped End	12	0.5	Clear	I
92872C	Clear Clear	Hardwired	Hardwired	Stripped End	12	0.5	Clear	I

LED

18 DIODE

## LED, 18 DIODE, 4"X2", SELF CONTAINED, SURFACE MOUNT, KIT

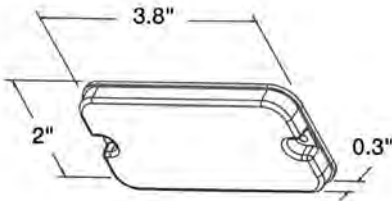

- 16 flash patterns including random
- 18 high-intensity LEDs
- Encapsulated electronics extend product life
- Synchronization capable



Part Number	Lens Color	Lamp Connector	Plug Side 1	Plug Side 2	Volts	Amps	Mount Color	Warning Class
92871R	Clear Red	Hardwired	Hardwired	Stripped End	12	0.5	Clear	I
92871Y	Clear Yellow	Hardwired	Hardwired	Stripped End	12	0.5	Clear	I
92871B	Clear Blue	Hardwired	Hardwired	Stripped End	12	0.5	Clear	I
92871C	Clear	Hardwired	Hardwired	Stripped End	12	0.5	Clear	I

## LED, 56 DIODE, 2"X6", SELF CONTAINED, SURFACE MOUNT



- 15 flash patterns including random
- 56 high-intensity LEDs
- Extremely thin design

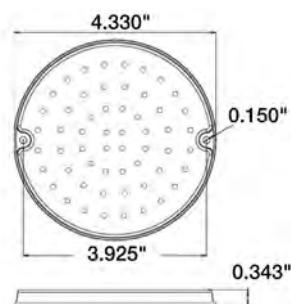

Part Number	Lens Color	Lamp Connector	Plug Side 1	Plug Side 2	Volts	Amps	Mount Color	Warning Class
92876R	Clear Red	Hardwired	Hardwired	Stripped End	12	0.8	Clear	I
92876Y	Clear Yellow	Hardwired	Hardwired	Stripped End	12	0.8	Clear	I

## LED, 56 DIODE, 2"X6", SELF CONTAINED, SURFACE MOUNT, KIT



- LED retrofit kit for front-loader waste haulers
- Features 2 LED Model 60 front, park and turn lamps and 4 LED Super 44 turn signal lamps

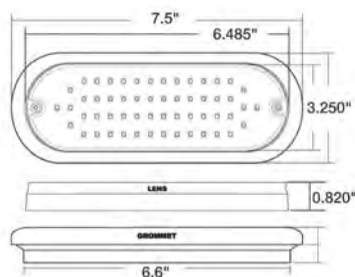

Part Number	Lens Color	Lamp Connector	Plug Side 1	Plug Side 2	Volts	Amps	Mount Color	Warning Class
92873R	Clear Red	Hardwired	Hardwired	Stripped End	12	0.8	Black	I
92873Y	Clear Yellow	Hardwired	Hardwired	Stripped End	12	0.8	Black	I

## LED, 56 DIODE, 4", SELF CONTAINED, SURFACE MOUNT

LED

56 DIODE

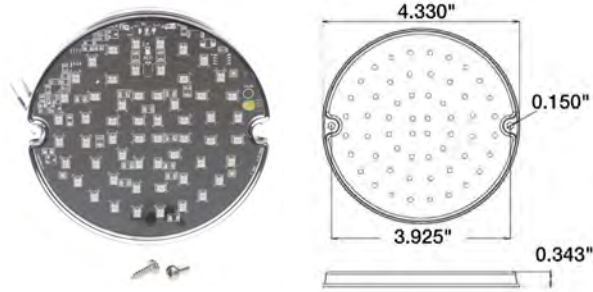

- 15 flash patterns including random
- 56 high-intensity LEDs
- Extremely thin design



Part Number	Lens Color	Lamp Connector	Plug Side 1	Plug Side 2	Volts	Amps	Mount Color	Warning Class
92876R	Clear Red	Hardwired	Hardwired	Stripped End	12	0.8	Clear	I
92876Y	Clear Yellow	Hardwired	Hardwired	Stripped End	12	0.8	Clear	I

## LED, 56 DIODE, 4", SELF CONTAINED, GROMMET MOUNT, KIT

LED

56 DIODE

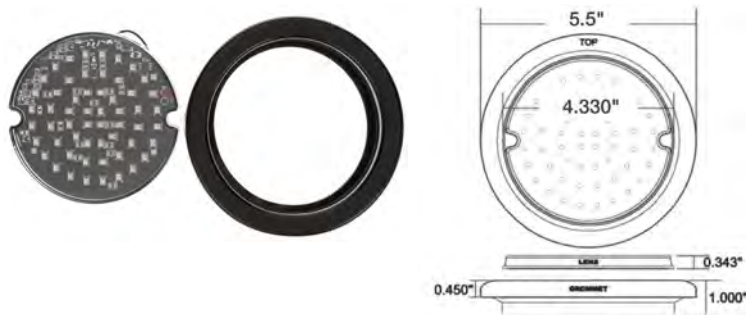

- 15 flash patterns including random
- 56 high-intensity LEDs
- Extremely thin design



Part Number	Lens Color	Lamp Connector	Plug Side 1	Plug Side 2	Volts	Amps	Mount Color	Warning Class
92874R	Clear Red	Hardwired	Hardwired	Stripped End	12	0.8	Black	I
92874Y	Clear Yellow	Hardwired	Hardwired	Stripped End	12	0.8	Black	I

## STROBE TUBE, INCANDESCENT, 1 BULB, 1", SELF-CONTAINED, FLANGE MOUNT

STROBE TUBE



- Smallest plug-in style strobe head assembly available
- Brighter and more effective than "wig-wag" halogen flashing lights
- Increases vehicle conspicuity to reduce accident rate (check local legal requirements and restrictions)
- Upgrades existing incandescent rear entry (composite) signal lamps
- Hideaway concept ideal for many types of vehicles found in fleets such as police, fire, ambulance, wrecker and municipal - where increased visibility is emphasized
- Simple installation: proper space must be available in existing composite lamp assembly for maximum reliability and intensity



Part Number	Lens Color	Lamp Connector	Plug Side 1	Plug Side 2	Volts	Amps	Mount Color
92846	Clear	Hardwired	Hardwired	3 Pin Connector	12 24	0.5	Black



## STROBE TUBE, INCANDESCENT, 1 BULB, 2"X5", REMOTED, FIX ANGLE BRACKET MOUNT



- Rugged polycarbonate lens and housing are sealed
- Foam gasket provides additional seal between the vehicle body and the lamp
- Includes weather-tight connectors
- Contains one flash tube rated for over five million flashes
- Surface mounts to the side, roof or rear of vehicle on two holes at 4.81" centers
- Provides 270 degrees of strobe warning light
- Upgraded from Packard to Deutsch connector, use #94236 adapter

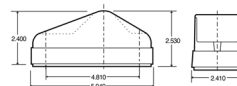

Part Number	Lens Color	Lamp Connector	Plug Side 1	Plug Side 2	Volts	Amps	Mount Color	Warning Class
92556Y	Yellow	Hardwired	Hardwired	3 Pin Weather tight Connector	12 24	2	Black	I

## STROBE TUBE, INCANDESCENT, 1 BULB, 2"X6", REMOTED GROMMET MOUNT, KIT



- Rugged polycarbonate lens and housing are welded
- Uses standard mounting accessories
- Includes mounting grommet and weather-tight connectors
- Contains one flash tube rate for over five million flashes
- Lamp flush mounts
- Upgraded from Packard to Deutsch connector, use #94236 adapter

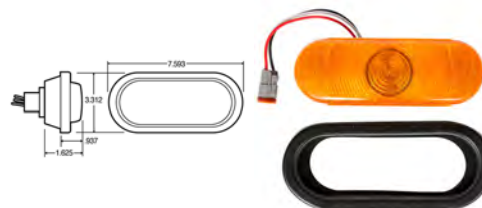

Part Number	Lens Color	Lamp Connector	Plug Side 1	Plug Side 2	Volts	Amps	Mount Color	Warning Class
92551Y	Yellow	Hardwired	Hardwired	3 Pin Weather tight Connector	12 24	2	Black	I

## STROBE TUBE, INCANDESCENT, 1 BULB, 3"X5", REMOTED GROMMET MOUNT, KIT



- Rugged polycarbonate lens and housing are sealed
- Uses standard mounting accessories
- Includes mounting grommet and weather-tight connectors
- Contains one flash tube rate for over five million flashes
- Ideal for use on LLV Postal vehicles
- Lamp flush mounts

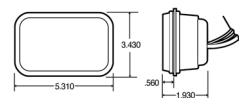

Part Number	Lens Color	Lamp Connector	Plug Side 1	Plug Side 2	Volts	Amps	Mount Color
92557Y	Yellow	Hardwired PL-2	Hard-wired PL-2	3 Pin Weather tight Connector	12 24	2	Black

STROBE TUBE

## STROBE TUBE, INCANDESCENT, 1 BULB, 4", REMOTED, GROMMET MOUNT, KIT

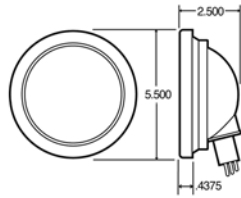

- Rugged polycarbonate lens and housing are sealed
- Uses standard mounting accessories
- Includes mounting grommet and weather-tight connectors
- Contains one flash tube rated for over five million flashes
- Lamp flush mounts
- Upgraded from Packard to Deutsch connector, use #94236 adapter



Part Number	Lens Color	Lamp Connector	Plug Side 1	Plug Side 2	Volts	Amps	Mount Color	Warning Class
92550Y	Yellow	Hardwired	Hardwired	3 Pin Weather tight Connector	12 24	2	Black	I

STROBE TUBE

## STROBE TUBE, INCANDESCENT, 1 BULB, 4", REMOTED, 1 STUD MOUNT

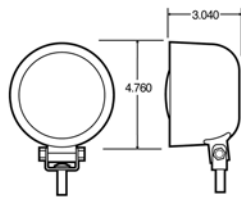

- Durable synthetic rubber housing resists corrosion
- Features high impact polycarbonate lens
- Mounts to the grill or rear of vehicle on one 5/16 -18 stud
- Features watertight connectors
- Contains one sealed-beam flash tube rated for over 5 million flashes
- Includes a universal mounting bracket
- Upgraded from Packard to Deutsch connector, use #94236 adapter



Part Number	Lens Color	Lamp Connector	Plug Side 1	Plug Side 2	Volts	Amps	Mount Color	Warning Class
92553Y	Yellow	Hardwired	Hardwired	3 Pin Weather tight Connector	12 24	2	Black	I
92555Y	Yellow	Hardwired	Hardwired	3 Pin Weather tight Connector	12 24	2	Black	I

STROBE TUBE

## STROBE TUBE, INCANDESCENT, 1 BULB, 7", REMOTED, 4 SCREW

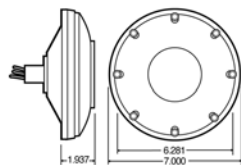

- Rugged polycarbonate lens and housing are sealed
- Includes weather tight-connectors
- Contains one flash tube rated for over five million flashes
- Surface mounts to the rear of vehicle by four holes on a 6.28" circle
- Upgraded from Packard to Deutsch connector, use #94236 adapter



Part Number	Lens Color	Lamp Connector	Plug Side 1	Plug Side 2	Volts	Amps	Warning Class
92552Y	Yellow	Hardwired	Hardwired	3 Pin Weather tight Connector	12 24	2	I

## HIDEAWAY SYSTEM, STROBE TUBE, 2 BULB, INCANDESCENT, 1", REMOTED, FLANGE MOUNT, KIT



- Hideaway system ideal for many types of vehicles found in fleets such as police, ambulance, fire, wrecker and municipal
- Emphasizes increased light visibility
- Increases vehicle conspicuity to reduce accidental rates (check local legal requirements and restrictions)
- Upgrades existing incandescent rear entry signal lamps
- Includes 2 hideaway light heads, 25W remote power supply and 15' shielded cable
- 10 selectable flash patterns
- Requires 1" diameter cutout in signal lamp



Part Number	Lens Color	Lamp Connector	Plug Side 1	Plug Side 2	Volts	Amps	Mount Color	Kit Includes
92844	Clear	Hardwired	Hardwired	3 Pin Connector	12 24	6	Black	92846 bulb, 9944 plug

## HIDEAWAY SYSTEM, STROBE TUBE, 4 BULB, INCANDESCENT, 1", REMOTED FLANGE MOUNT, KIT



- Hideaway system ideal for many types of vehicles found in fleets such as police, fire, ambulance, wrecker and municipal
- Emphasizes increased light visibility
- Increases vehicle conspicuity to reduce accidental rates (check local requirements and restrictions)
- Upgrades existing incandescent rear entry signal lamps
- 10 selectable flash patterns
- Requires 1" diameter cutout in signal lamp
- Includes 4 hideaway light heads, 60W remote power supply and 15' shielded cable



Part Number	Lens Color	Lamp Connector	Plug Side 1	Plug Side 2	Volts	Amps	Mount Color	Kit Includes
92845	Clear	Hardwired	Hardwired	3 Pin Connector	12 24	6	Black	92846 bulb, 6660ps supply, 9944 plug

## LED, CLASS 1, HIGH PROFILE , PERMANENT MOUNT

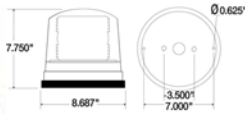

- Clear cover seals out dirt and can be cleaned easily
- 24 selectable flash patterns via internal jumper
- LED diagnostic indicator
- Modular circuit is completely encapsulated for increased shock & weather resistance
- Mounts easily with two toggle bolts on 3-1/2" centers



Part Number	Lens Color	Plug Side 2	Volts	Amps Major/Minor	Warning Class	Selectable Flash Patterns (Y/N)
92865Y	Yellow	Stripped End	12 24	0.41	I	Yes

## LED, CLASS 1, MEDIUM PROFILE, PERMANENT MOUNT, PIPE MOUNT

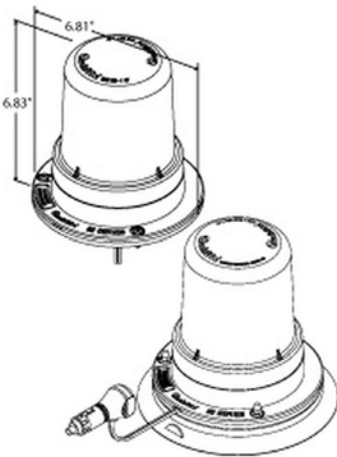

- Optics designed specifically for LED Technology, not as a gaseous discharge retrofit
- Additional color options excellent option for city/county municipal, cement mixer, and other heavy-duty, construction or off-road applications
- Dual and quad Class I flash patterns meet legal functions
- Rugged black powder coated corrosion-resistant die-cast aluminum base
- Designed for surface mount as well as pipe mount (1NPT pipe thread)
- Electronics and light source are fully encapsulated in epoxy to protect components from moisture damage and corrosives
- Protected against industry-standard electrical transient per SAE J1455
- Linear supply offers reduced EMI over that of gaseous discharge systems
- Threaded lens design does not require tool to replace lens
- Designed without external optics to reduce maintenance and cleaning
- Mounting gasket and #10 installation screws included
- Magnetic mount version features neodymium magnets, the strongest type of magnet, featuring up to 120 pounds of magnetic pull
- Magnetic mount includes rubber suction material for extra insurance, reducing any risk of separation of light from contact surface
- Cigarette plug features on/off switch with LED indicator light



Part Number	Lens Color	Plug Side 2	Volts	Amps Major/Minor	Warning Class	Selectable Flash Patterns (Y/N)
92565Y	Yellow	Stripped End	12	2.6	I	No
92566Y	Yellow Clear	Stripped End	12	2.6	I	No
92565R	Red	Stripped End	12	2.6	I	No
92565B	Blue	Stripped End	12	2.6	I	No
92565C	Clear	Stripped End	12	2.6	I	No
92568Y	Yellow	Stripped End	24	1.3	I	No
92568R	Red	Stripped End	24	1.3	I	No
92568B	Blue	Stripped End	24	1.3	I	No
92568C	Clear	Stripped End	24	1.3	I	No
92860Y	Yellow	Stripped End	12 24	0.3	I	No

## LED, CLASS 1, MEDIUM PROFILE, PERMANENT MOUNT



- 24 selectable flash patterns via internal jumper
- LED diagnostic indicator
- Modular circuit is completely encapsulated for increased shock and weather resistance

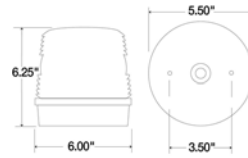

Part Number	Lens Color	Plug Side 2	Volts	Amps Major/Minor	Warning Class	Selectable Flash Patterns (Y/N)
92864Y	Yellow	Stripped End	12 24	0.41	I	Yes

## LED, CLASS 1, LOW PROFILE, PERMANENT MOUNT, PIPE MOUNT



- Meets Class I output requirements.
- Optics designed specifically for LED technology, not as a gaseous discharge retrofit
- Dual and quad flash patterns meet legal functions
- Rugged black powder coated corrosion-resistant die-cast aluminum base
- Designed for surface mount as well as pipe mount (1" NPT pipe thread)
- Electronics and light source are fully encapsulated in epoxy
- Protected against industry-standard electrical transient per SAE J1455
- Linear supply offers reduced EMI over that of gaseous discharge systems
- Threaded-lens design does not require tool to replace lens
- Designed without external optics to reduce maintenance and cleaning
- Mounting gasket and #10 installation screws included

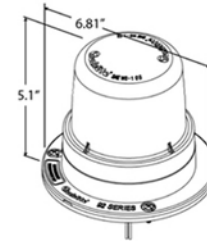

Part Number	Lens Color	Plug Side 2	Volts	Amps Major/Minor	Warning Class	Selectable Flash Patterns (Y/N)
92564C	Clear	Stripped End	12	2.2	I	No
92564Y	Yellow	Stripped End	12	2.2	I	No

## LED, CLASS 2, LOW PROFILE, PERMANENT MOUNT

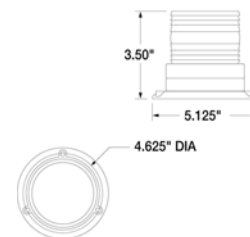

Part Number	Lens Color	Plug Side 2	Volts	Amps Major/Minor	Warning Class	Selectable Flash Patterns (Y/N)
307A	Yellow	Stripped End	12 24 36 48	0.5	III	No
300A	Yellow	Stripped End	12	0.35	III	Yes

LED  
CLASS 2

## LED, CLASS 2, LOW PROFILE, PERMANENT MOUNT, PIPE MOUNT

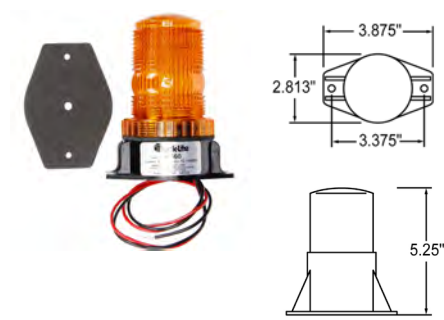

- Ideal for material handling market
- Recognized under the Component Program of Underwriters Laboratories, Inc. for battery-powered industrial truck accessory
- Flash rate and intensity: 85 FPM, 1.5Joule/175,000 CP (strobe)
- Only 0.5 amp at 12 VDC, 0.25 amp at 24 VDC (strobe) .35V (LED)
- 12-110V (strobe) 10-16V (LED)
- 29 selectable flash patterns
- Fully encapsulated LED circuitry ensures trouble-free operation
- Polycarbonate base and domes provide excellent durability
- Review installation instructions and warning labels for proper use



Part Number	Lens Color	Plug Side 2	Volts	Amps Major/Minor	Warning Class	Selectable Flash Patterns (Y/N)
92534Y	Yellow	Stripped End	12	0.5	III	No
92560	Yellow	Stripped End	12 24 36 48	0.55	III	No
92563	Yellow	Stripped End	12	0.35	III	Yes
92862Y	Yellow	Stripped End	12 24	0.3	II	No

LED  
CLASS 2

## LED, CLASS 2, LOW PROFILE, MAGNETIC MOUNT



- Modular components and encapsulated circuitry make for quick repairs and minimize downtime
- Designed with solid-state electronics for long-term dependability
- Features reverse polarity protection
- Operates in temperature ranging from -20°F to 135°F
- Operates at 12v, .5 amp and uses 3.0 joules per flash
- Mounts with 1/2" conduit pipe and includes knockouts for permanent surface mounting
- Review installation instructions and warning labels for proper use



Part Number	Lens Color	Plug Side 2	Volts	Amps Major/Minor	Warning Class	Selectable Flash Patterns (Y/N)
313A	Yellow	Cigarette Adapter	12 24 36 48	0.5	III	No
92539Y	Yellow	Cigarette Adapter	12	0.5	III	No
301A	Yellow	Cigarette Adapter	12	0.35	III	Yes
92863Y	Yellow	Cigarette Adapter	12 24	0.3	II	No

## HALOGEN, CLASS 1, PERMANENT MOUNT



- Rubbolite M153 series and approved rotating halogen beacons
- Magnetic mount with cigarette plug adapter
- 3-bolt mounting with 16 gauge wire

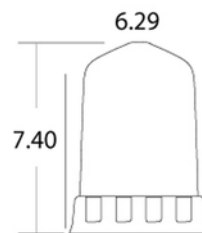

Part Number	Lens Color	Plug Side 2	Volts	Warning Class	Selectable Flash Patterns (Y/N)
6822A	Yellow	Blunt Cut	12	I	No

HALOGEN

CLASS 1

## HALOGEN, CLASS 1, MAGNETIC MOUNT



- Rubbolite M153 series and approved rotating halogen beacons
- Magnetic mount with cigarette plug adapter
- 3-bolt mounting with 16 gauge wire

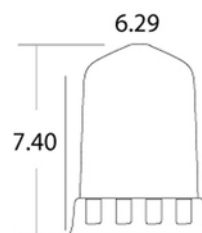

Part Number	Lens Color	Plug Side 2	Volts	Warning Class	Selectable Flash Patterns (Y/N)
6823A	Yellow	Cigarette Adapter	12	I	No

HALOGEN

CLASS 1

## HALOGEN, CLASS 2, MAGNETIC MOUNT

- Truck-Lite has replaced revolving beacon 333/333A to an upgraded version, 92602R/92602Y
- Meets Class 1, SAE J845
- Improved rotating gear drive mechanism for quieter operation
- Improved dual magnetic mounting, less prone to scratch vehicle paint
- Rate RPM: 120 +/- 5/minute
- Temperature Range: -4° F to 122° F

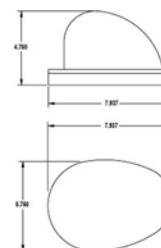

Part Number	Lens Color	Plug Side 2	Volts	Amps Major/Minor	Warning Class	Selectable Flash Patterns (Y/N)
92602B	Blue	Cigarette Adapter	12	3.5	II	No
92602Y	Yellow	Cigarette Adapter	12	3.5	II	No
92620Y	Yellow	Cigarette Adapter	12	1.7	II	No

HALOGEN

CLASS 2

## GAS DISCHARGE, CLASS 1, HIGH PROFILE, PERMANENT MOUNT



- Double and quad flash versions operate at 12V or 24V, 2.0 amp and can be wired for high power (15 joules) or for low power (10 joules)
- Single-flash version operates at 12v, 1.8 and uses 8.0 joules per flash
- Clear cover seals out dirt and can be cleaned easily
- Modular components and encapsulated circuitry make for quick repairs
- Features reverse polarity protection
- Operates in temperatures from -20°F to +135°F
- Mounts easily with two toggle bolts at 3 1/2" centers
- Meets SAE J1318 Class 1-2-3 for double/quad flash or Class 2-3 for single flash
- Review installation instructions and warning labels for proper use



Part Number	Lens Color	Plug Side 2	Volts	Amps Major/Minor	Warning Class	Selectable Flash Patterns (Y/N)
92513Y	Yellow	Stripped End	12 24	2	I	Yes

## GAS DISCHARGE, CLASS 1, MEDIUM PROFILE, PERMANENT MOUNT



- Quad flash, operates at 12V or 24V, 2.0 amp and can be wired for high power (15 joules) or for low power (10 joules)
- Modular components and encapsulated circuitry make for quick repairs
- Designed with solid state electronics for long-term dependability
- Features reverse polarity protection
- Operates in temperatures from -20°F to +135°F
- Mounts with 1/2" conduit pipe and includes knock-outs for permanent surface mounting
- Meets SAE J1318 Class 1-2-3 for quad flash
- Review installation instructions and warning labels for proper use

Part Number	Lens Color	Plug Side 2	Volts	Amps Major/Minor	Warning Class	Selectable Flash Patterns (Y/N)
92516Y	Yellow	Stripped End	12 24	2	I	Yes
92516C	Clear	Stripped End	12 24	2	I	Yes



## GAS DISCHARGE, CLASS 1, MEDIUM PROFILE, PERMANENT MOUNT, PIPE MOUNT



- Multi-flash class 2 gas discharge strobe
- Field-selectable flash patterns via internal jumper single, double, quad flash
- Modular circuit is completely encapsulated for increased shock and weather resistance
- New design features twist on/off lens

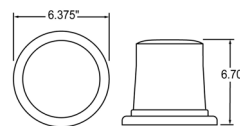

Part Number	Lens Color	Plug Side 2	Volts	Amps Major/Minor	Warning Class	Selectable Flash Patterns (Y/N)
6601A	Yellow	Stripped End	12	2	I	Yes
6811A	Yellow	Stripped End	12 24	2	I	Yes

GAS DISCHARGE

CLASS 1

## GAS DISCHARGE, CLASS 1, MEDIUM PROFILE, MAGNETIC MOUNT



- Multi-flash class 2 gas discharge strobe
- Field-selectable flash patterns via internal jumper single, double, quad flash
- Modular circuit is completely encapsulated for increased shock and weather resistance
- New design features twist on/off lens

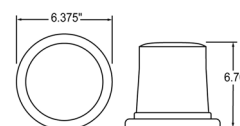

Part Number	Lens Color	Plug Side 2	Volts	Amps Major/Minor	Warning Class	Selectable Flash Patterns (Y/N)
6601MA	Yellow	Cigarette Adapter	12	2	I	Yes
6811MA	Yellow	Cigarette Adapter	12 24	2	I	Yes

GAS DISCHARGE

CLASS 1

## GAS DISCHARGE, CLASS 1, LOW PROFILE, PERMANENT MOUNT



- Rugged polycarbonate and anodized, spun aluminum construction
- Includes 180" cable
- Contains one flash tube rated for over five million flashes
- Upgraded from Packard to Deutsch connector, use #94236 adapter

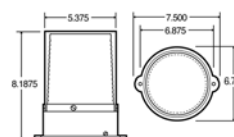

Part Number	Lens Color	Plug Side 2	Volts	Warning Class	Selectable Flash Patterns (Y/N)
92554Y	Yellow	3 Pin Weather tight Connector	12 24	I	No

GAS DISCHARGE

CLASS 1

## GAS DISCHARGE, CLASS 1, LOW PROFILE, PERMANENT MOUNT



- Rugged polycarbonate and anodized, spun aluminum construction
- Includes 180" cable
- Contains one flash tube rated for over five million flashes
- Upgraded from Packard to Duetch connector, use #94236 adapter



Part Number	Lens Color	Plug Side 2	Volts	Amps Major/Minor	Warning Class	Selectable Flash Patterns (Y/N)
6600A	Yellow	Stripped End	12	2	I	Yes
6600B	Blue	Stripped End	12	2	I	Yes
6600W	Clear	Stripped End	12	2	I	Yes
6810A	Yellow	Stripped End	12 24	2	I	Yes

## GAS DISCHARGE, CLASS 1, LOW PROFILE, MAGNETIC MOUNT



- Multi-flash Class 2 gas discharge strobe
- Field-selectable flash patterns via internal jumper single, double, quad flash
- Modular circuit is completely encapsulated for increased shock and weather resistance
- New design features twist on/off lens
- Electronics sealed in epoxy for increased weather and shock resistance



Part Number	Lens Color	Plug Side 2	Volts	Amps Major/Minor	Warning Class	Selectable Flash Patterns (Y/N)
6600MA	Yellow	Cigarette Adapter	12	2	I	Yes
6810MA	Yellow	Cigarette Adapter	12 24	2	I	Yes

# Looking for even more product information?

Visit [truck-lite.com](http://truck-lite.com)



**Powerful Search  
Function**



**360° Product  
Images**



**Easy-To-Find  
Replacement  
Parts**

## LED, 4" X 36", PERMANENT MOUNT

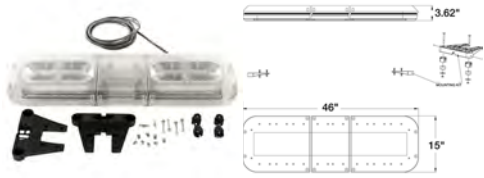

- 35 selectable flash patterns via external wire
- Adjustable lower level lights allow customizable positioning of light output
- Conformal coated circuitry protects against shock & vibration
- Dual-level, full-output light bar less than 4" tall
- High/low power select
- Independent enable of front and rear facing LEDs
- Low-input voltage detection under 10V DC



Part Number	Lens Color	Plug Side 2	Volts	Amps	Lens Material	Housing Material	Warning Class
92867Y	Clear / Yellow	Stripped End	12 24	4.6	PC	PC	I

## LED, 5" X 19", PERMANENT MOUNT

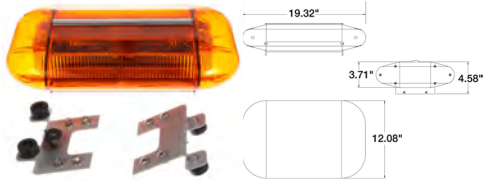

- Compact and quiet operation
- LED version features 20 selectable flash patterns via external pattern
- Select wire or internal jumper



Part Number	Lens Color	Plug Side 2	Volts	Amps	Lens Material	Housing Material	Warning Class
92866Y	Yellow	Stripped End	12 24	2	PC	Aluminum	I

## LED, 5" X 47", PERMANENT MOUNT

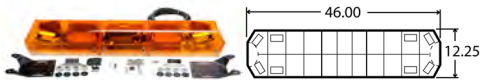

- Perfect for all warning applications, including tow trucks, construction, utility and D.O.T. vehicles
- Generates an incredibly bright, powerful signal with rich, true color
- Sleek appearance also produces less drag increasing fuel efficiency
- Powered through standard 12V input
- All voltage management handled at the light head
- Complies with SAE and California Title XIII when properly configured



Part Number	Lens Color	Plug Side 2	Volts	Amps	Lens Material	Housing Material	Warning Class
92590Y	Yellow	Blunt Cut	12	2	PC	Aluminum	I

## INCANDESCENT, 5" X 46", PERMANENT MOUNT



- Features rear traffic director combined with standard light bars for maximum versatility
- Strobe version includes four 360° remote strobe heads, two double mirrors, two mirrors, one 4-head strobe pack, rear lower directional arrow assembly with colored lenses
- Halogen version includes two halogen rotators, two fast halogen rotators, three double mirrors, rear lower directional arrow assembly with colored lenses
- Review installation instructions and warning label for proper use

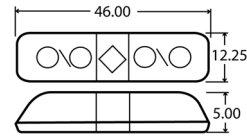

Part Number	Lens Color	Plug Side 2	Volts	Amps	Lens Material	Housing Material
92673Y	Yellow	Stripped End/Control Unit Connector	12	8.6	PC	PC

INCANDESCENT

LIGHT BAR

## HALOGEN, 4.5" X 16", PERMANENT MOUNT



- Features two internal mirrors to enhance flashes
- Two halogen rotators
- Compact unit operates quietly
- Magnetic mount includes integral cigarette lighter adapter with 6' cord
- Flashes at a rate of 85 fpm while drawing 8.0 amp
- Review installation instructions and warning labels for proper use
- Plastic base resists corrosion

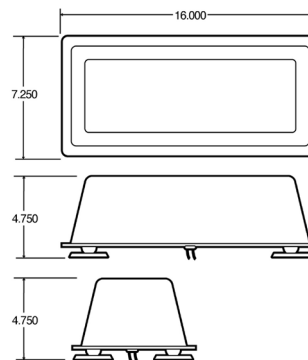

Part Number	Lens Color	Plug Side 2	Volts	Amps	Lens Material	Housing Material	Warning Class
92524Y	Yellow	Stripped End	12	8	PC	PC	I

HALOGEN

LIGHT BAR

## HALOGEN, 4.5" X 16", MAGNETIC MOUNT



- Features two internal mirrors to enhance flashes
- Two halogen rotators
- Compact unit operates quietly
- Magnetic mount includes integral cigarette lighter adapter with 6' cord
- Flashes at a rate of 85 fpm while drawing 8.0 amp
- Review installation instructions and warning labels for proper use
- Plastic base resists corrosion

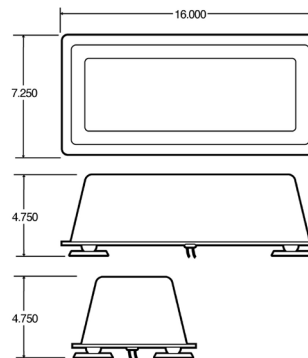

Part Number	Lens Color	Plug Side 2	Volts	Amps	Lens Material	Housing Material	Warning Class
92525B	Blue	Cigarette Adapter	12	8	PC	PC	I
92525Y	Yellow	Cigarette Adapter	12	8	PC	PC	I

HALOGEN

LIGHT BAR

## HALOGEN, 5" X 36", PERMANENT MOUNT



- Halogen version includes two halogen rotators, two fast halogen rotators and two double mirrors
- Features two 360° strobe heads, one 2-head strobe, two double mirrors
- Linear strobe version features four 4.5" linear strobe heads, four 7" linear strobe heads, two 4 head strobe's
- Compact unit operates quietly
- 110 FPM, 2 amp draw
- Review installation instructions and warning labels for proper use



Part Number	Lens Color	Plug Side 2	Volts	Amps	Lens Material	Housing Material
92668Y	Yellow	Stripped End	12	16	PC	PC

## HALOGEN, 5" X 46", PERMANENT MOUNT



- Halogen version includes two halogen rotators, two fast halogen rotators and two double mirrors
- Features two 360° strobe heads, one 2-head strobe, two double mirrors
- Linear strobe version features four 4.5" linear strobe heads, four 7" linear strobe heads, two 4 head strobe's
- Compact unit operates quietly
- 110 FPM, 2 amp draw
- Review installation instructions and warning labels for proper use



Part Number	Lens Color	Plug Side 2	Volts	Amps	Lens Material	Housing Material
92670Y	Yellow	Stripped End	12	16	PC	PC
92672Y	Yellow	Stripped End/Control Unit Connector	12	16	PC	PC

## HALOGEN, 5" X 47", MAGNETIC MOUNT

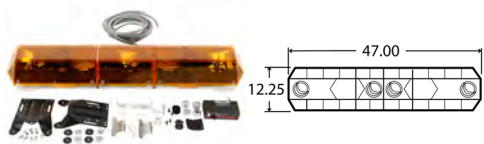

- Features dual decks for power and flexibility
- Extruded aluminum frame will not warp or bend
- Meets SAE J1318 Class I requirements
- Built-in rear traffic director
- H1 55W halogen rotating assemblies
- 18' harness exits on driver's side
- Dimensions: 5.75" H x 12.25" W



Part Number	Lens Color	Plug Side 2	Volts	Amps	Lens Material	Housing Material	Warning Class
92674Y	Yellow	Blunt Cut	12	4	PC	PC	I
92677Y	Yellow	Blunt Cut	12	8	PC	PC	I

## GAS DISCHARGE, 4.5" X 16", PERMANENT MOUNT



- Features two internal mirrors to enhance flashes
- Available with two 15-joule strobe heads in double flash or quad flash versions
- Compact unit operates quietly
- Magnetic mount includes integral cigarette lighter adapter with 6' cord
- Flashes at a rate of 110 FPM while drawing 2.0 amp
- Review installation instructions and warning labels for proper use

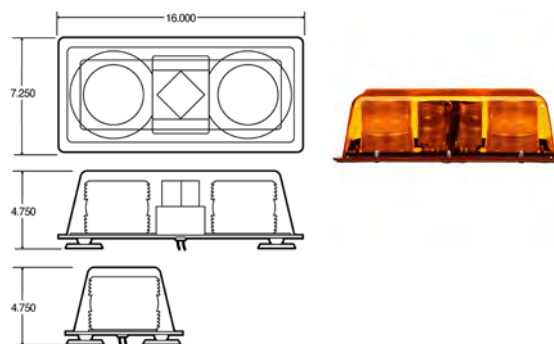

Part Number	Lens Color	Plug Side 2	Volts	Amps	Lens Material	Housing Material	Warning Class
92522Y	Yellow	Stripped End	12 24	2	PC	PC	II

## GAS DISCHARGE, 4.5" X 16", MAGNETIC MOUNT



- Features two internal mirrors to enhance flashes
- Available with two 15-joule strobe heads in double flash or quad flash versions
- Compact unit operates quietly
- Magnetic mount includes integral cigarette lighter adapter with 6' cord
- Flashes at a rate of 110 FPM while drawing 2.0 amp
- Review installation instructions and warning labels for proper use

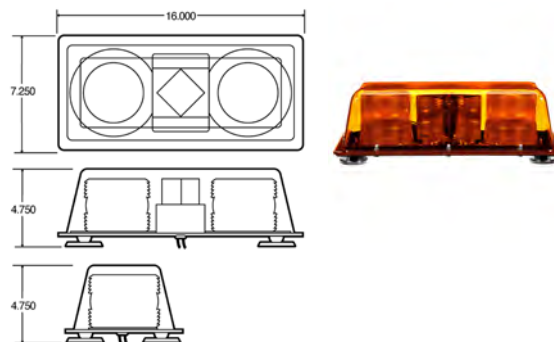

Part Number	Lens Color	Plug Side 2	Volts	Amps	Lens Material	Housing Material	Warning Class
92523Y	Yellow	Cigarette Adapter	12 24	2	PC	PC	II

## GAS DISCHARGE, 5" X 36", PERMANENT MOUNT



- Halogen version includes two halogen rotators, two fast halogen rotators and two double mirrors
- Features two 360° strobe heads, one 2-head strobe, two double mirrors
- Linear strobe version features four 4.5" linear strobe heads, four 7" linear strobe heads, two 4 head strobe's
- Compact unit operates quietly
- 110 FPM, 2 amp draw
- Review installation instructions and warning labels for proper use



Part Number	Lens Color	Plug Side 2	Volts	Amps	Lens Material	Housing Material
92669Y	Yellow	Stripped End	12	2	PC	PC
92671Y	Yellow	Stripped End	12	8.6	PC	PC

LED

## LED, TRAFFIC CONTROL LIGHT BAR MODULE

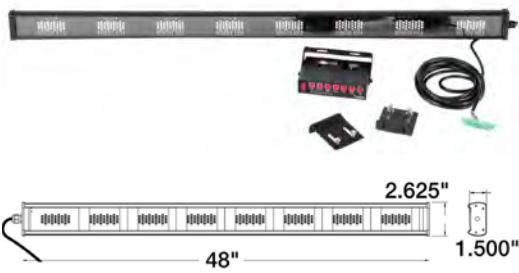

- Sealed design provides extreme weather resistance
- Control unit is operated with a combined circuit
- Highly efficient LED optics
- Control unit is micro-processor controlled with tactile front
- Heavy duty housing is resistant to warping, bending and/or corroding



Part Number	Lens Color	Plug Side 2	Volts	Amps	Lens Material	Housing Material
92868Y	Clear Yellow	Control Unit Connector	12	2.1	PC	Aluminum

LED

SIGNAL-STAT

## SIGNAL-STAT, LED, TRAFFIC ADVISOR W/CONTROL HEAD

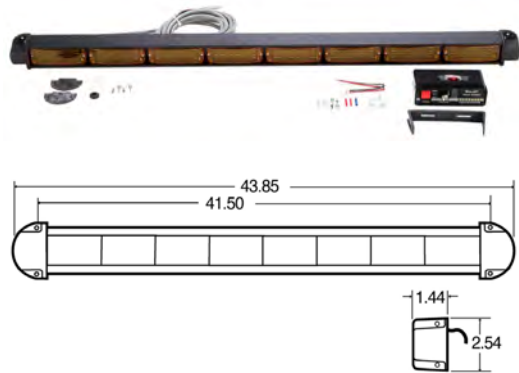

- Perfect for mounting to a utility body, the rear of a light bar, or as a stand alone rear deck unit
- Lightweight aluminum housing
- LED model features low-profile surface mount which installs easily with just four screws
- Includes mounting hardware, control head, 15' cable and connectors
- LED model offers long life (LEDs rated for 100,000 hours) and low current draw (.5 amp per lamp)
- Control head features four operating modes and eight programmable patterns with LED display of pattern in operation



Part Number	Lens Color	Plug Side 2	Volts	Amps	Lens Material	Housing Material
19680A	Yellow	Stripped End	12	0.5	PC	Aluminum



## HALOGEN, ROTATOR TRAFFIC BAR



- Features compact design with dual decks
- Extruded aluminum frame will not warp or bend
- Meets SAE J1318 Class I requirements
- Built-in rear traffic director
- H1 55W halogen rotating assemblies
- Two diamond mirrors
- Dimensions: 4.5" H x 12.25" W x 47" L

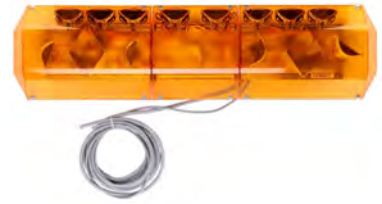
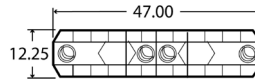

Part Number	Lens Color	Plug Side 2	Volts	Amps	Lens Material	Housing Material	Warning Class
92676Y	Yellow	Blunt Cut	12	1.5	Polycarbonate	Polycarbonate	I

HALOGEN

## HALOGEN, ROTATOR LIGHT BAR



- Extruded aluminum base will not warp or bend
- Efficient parabola reflector provides excellent light dispersion and intensity
- 3-year manufacturer's motor assembly warranty
- Includes 15' shielded cable and detailed instructions
- Dimensions: 5.125" H x 6.3125" W x 47" L

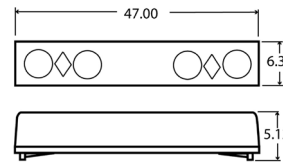

Part Number	Lens Color	Plug Side 2	Volts	Amps	Lens Material	Housing Material
92685Y	Yellow	Stripped End	12	6	Polycarbonate	Polycarbonate

HALOGEN

## CONTROL BOX, TRAFFIC CONTROL BOX

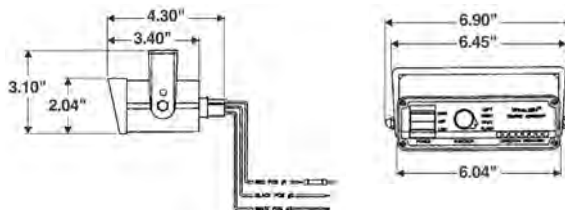

92849

Part Number	Volts	Amps	Plug Side 2	Housing Material
92760			Control Unit Connector	Steel
92849	12	5	Control Unit Connector	Steel



92760

TRAFFIC CONTROL BOX

# INTERIOR UTILITY & DOME LIGHTS

## LED

Pages 290-297

SERIES	COMMON SIZE	PAGES
33® Series	0.75"	290-291
Super 33®	0.75"	292-293
36 Series	1" x 2"	293
44® Series	4"	294
Super 44®	4"	295
80 Series	Multiple	296-297
84 Series	2" x 48"	297
Signal-Stat 3in x 10in	3" x 10"	297

## INCANDESCENT

Pages 298-305

SERIES	COMMON SIZE	PAGES
10® Series	2" x 5"	298
Super 10® Series	2" x 5"	298
12® Series	2" x 3"	299
15® Series	1" x 2"	299
19® Series	1" x 4"	299
20® Series	2"	300
26 Series	Multiple	300
30® Series	2"	300
40® Series	4"	301-302
Incandescent 1 Bulb	Multiple	302-303
Incandescent Signal-Stat	Multiple	304-305

## FLUORESCENT

Page 306

SERIES	COMMON SIZE	PAGES
2 Bulb 5in x 18in	5" x 18"	306
2 Bulb 6in x 21in	6" x 21"	306

LED

33 SERIES

### 33<sup>®</sup> SERIES, LED, 1 DIODE, 0.75", GROMMET MOUNT

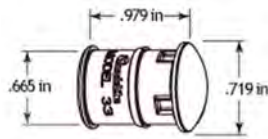

- Excellent choice for interior applications such as truck cab, walkways, glove boxes, step lights, puddle lights and more
- Creates additional options for improving custom look and theme of vehicle exteriors, mounted on separate switch
- Hardwired lamp design easily retrofitted
- Low profile reduces damage from impact
- LEDs draw less current, allowing more power for other vehicle requirements
- Reduces lighting costs due to physical damage and heat entrapment
- Electronics completely sealed in epoxy to resist corrosion and moisture
- Designed for auxiliary lamp use only
- US Patent #6612728
- Not recommended for marker/clearance purposes



Part Number	Lamp Connector	Plug Side 1	Plug Side 2	Lens Color	Lens Material	Volts	Amps
33265B	Hardwired	Hardwired	.180 Bullet	Blue	PC	12	0.04
33265C	Hardwired	Hardwired	.180 Bullet	Clear	PC	12	0.04
33265G	Hardwired	Hardwired	.180 Bullet	Green	PC	12	0.04
33265PR	Hardwired	Hardwired	.180 Bullet	Purple	PC	12	0.04
33265R	Hardwired	Hardwired	.180 Bullet	Red	PC	12	0.04
33265Y	Hardwired	Hardwired	.180 Bullet	Yellow	PC	12	0.04

LED

33 SERIES

### 33<sup>®</sup> SERIES, LED, 1 DIODE, 0.75", GROMMET MOUNT, KIT

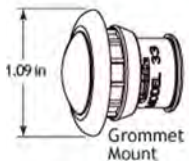

- Excellent choice for interior applications such as truck cab, walkways, glove boxes, step lights, puddle lights and more
- Creates additional options for improving custom look and theme of vehicle exteriors, mounted on separate switch
- Hardwired lamp design easily retrofitted
- Low profile reduces damage from impact
- LEDs draw less current, allowing more power for other vehicle requirements
- Reduces lighting costs due to physical damage and heat entrapment
- Electronics completely sealed in epoxy to resist corrosion and moisture
- Designed for auxiliary lamp use only
- US Patent #6612728
- Not recommended for marker/clearance purposes



Part Number	Lamp Connector	Plug Side 1	Plug Side 2	Lens Color	Lens Material	Mount Color	Volts	Amps	Kit Includes
33060PR	Hardwired	Hardwired	.180 Bullet	Purple	PC	Black	12	0.13	33260PR light, 33700 grommet
33065B	Hardwired	Hardwired	.180 Bullet	Blue	PC	Black	12	0.06	33265B light, 33700 grommet
33065C	Hardwired	Hardwired	.180 Bullet	Clear	PC	Black	12	0.06	33265C light, 33700 grommet
33065G	Hardwired	Hardwired	.180 Bullet	Green	PC	Black	12	0.06	33265G light, 33700 grommet
33065PR	Hardwired	Hardwired	.180 Bullet	Purple	PC	Black	12	0.06	33265PR light, 33700 grommet
33065R	Hardwired	Hardwired	.180 Bullet	Red	PC	Black	12	0.06	33265R light, 33700 grommet
33065Y	Hardwired	Hardwired	.180 Bullet	Yellow	PC	Black	12	0.06	33265Y light, 33700 grommet
33095G	Hardwired	Hardwired	.180 Bullet	Green	PC	Black	12	0.06	33265G light, 33725 grommet

## 33<sup>®</sup> SERIES, LED, 1 DIODE, 0.75", FLANGE MOUNT, KIT



- Excellent choice for interior applications such as truck cab, walkways, glove boxes, step lights, puddle lights and more
- Creates additional options for improving custom look and theme of vehicle exteriors, mounted on separate switch
- Hardwired lamp design easily retrofitted
- Low profile reduces damage from impact
- LEDs draw less current, allowing more power for other vehicle requirements
- Reduces lighting costs due to physical damage and heat entrapment
- Electronics completely sealed in epoxy to resist corrosion and moisture
- Designed for auxiliary lamp use only
- US Patent #6612728
- Not recommended for marker/clearance purposes

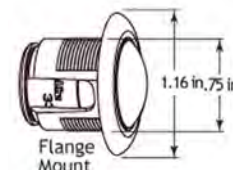

Part Number	Lamp Connector	Plug Side 1	Plug Side 2	Lens Color	Lens Material	Mount Color	Volts	Amps	Kit Includes
33062PR	Hardwired	Hardwired	.180 Bullet	Purple	PC	Chrome	12	0.13	33260PR light, 33810 grommet
33066B	Hardwired	Hardwired	.180 Bullet	Blue	PC	Black	12	0.06	33265B light, 33800 grommet
33066C	Hardwired	Hardwired	.180 Bullet	Clear	PC	Black	12	0.06	33265C light, 33800 grommet
33066G	Hardwired	Hardwired	.180 Bullet	Green	PC	Black	12	0.06	33265G light, 33800 grommet
33066PR	Hardwired	Hardwired	.180 Bullet	Purple	PC	Black	12	0.06	33265PR light, 33800 grommet
33066R	Hardwired	Hardwired	.180 Bullet	Red	PC	Black	12	0.06	33265R light, 33800 grommet
33066Y	Hardwired	Hardwired	.180 Bullet	Yellow	PC	Black	12	0.06	33265Y light, 33800 grommet
33067B	Hardwired	Hardwired	.180 Bullet	Blue	PC	Chrome	12	0.06	33265B light, 33810 grommet
33067C	Hardwired	Hardwired	.180 Bullet	Clear	PC	Chrome	12	0.06	33265C light, 33810 grommet
33067G	Hardwired	Hardwired	.180 Bullet	Green	PC	Chrome	12	0.06	33265G light, 33810 grommet
33067PR	Hardwired	Hardwired	.180 Bullet	Purple	PC	Chrome	12	0.06	33265PR light, 33810 grommet
33067R	Hardwired	Hardwired	.180 Bullet	Red	PC	Chrome	12	0.06	33265R light, 33810 grommet
33067Y	Hardwired	Hardwired	.180 Bullet	Yellow	PC	Chrome	12	0.06	33265Y light, 33810 grommet

LED

SUPER 33

## SUPER 33, LED, 1 DIODE, 0.75", GROMMET MOUNT

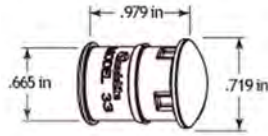

- Excellent choice for interior applications such as truck cab, walkways, glove boxes, step lights, puddle lights and more
- Creates additional options for improving custom look and theme of vehicle exteriors, mounted on separate switch
- Hardwired lamp design easily retrofitted
- Low profile reduces damage from impact
- LEDs draw less current, allowing more power for other vehicle requirements
- Reduces lighting costs due to physical damage and heat entrapment
- Electronics completely sealed in epoxy to resist corrosion and moisture
- Designed for auxiliary lamp use only
- US Patent #6612728
- Not recommended for marker/clearance purposes



Part Number	Lamp Connector	Plug Side 1	Plug Side 2	Lens Color	Lens Material	Volts	Amps
33260B	Hardwired	Hardwired	.180 Bullet	Blue	PC	12	0.13
33260C	Hardwired	Hardwired	.180 Bullet	Clear	PC	12	0.13
33260G	Hardwired	Hardwired	.180 Bullet	Green	PC	12	0.13
33260PR	Hardwired	Hardwired	.180 Bullet	Purple	PC	12	0.13
33260R	Hardwired	Hardwired	.180 Bullet	Red	PC	12	0.13
33260Y	Hardwired	Hardwired	.180 Bullet	Yellow	PC	12	0.13

LED

SUPER 33

## SUPER 33, LED, 1 DIODE, 0.75", GROMMET MOUNT, KIT

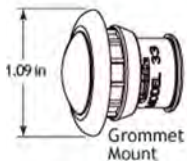

- Excellent choice for interior applications such as truck cab, walkways, glove boxes, step lights, puddle lights and more
- Creates additional options for improving custom look and theme of vehicle exteriors, mounted on separate switch
- Hardwired lamp design easily retrofitted
- Low profile reduces damage from impact
- LEDs draw less current, allowing more power for other vehicle requirements
- Reduces lighting costs due to physical damage and heat entrapment
- Electronics completely sealed in epoxy to resist corrosion and moisture
- Designed for auxiliary lamp use only
- US Patent #6612728
- Not recommended for marker/clearance purposes



Part Number	Lamp Connector	Plug Side 1	Plug Side 2	Lens Color	Lens Material	Mount Color	Volts	Amps	Kit Includes
33060B	Hardwired	Hardwired	.180 Bullet	Blue	PC	Black	12	0.13	33260B light, 33700 grommet
33060C	Hardwired	Hardwired	.180 Bullet	Clear	PC	Black	12	0.13	33260C light, 33700 grommet
33060G	Hardwired	Hardwired	.180 Bullet	Green	PC	Black	12	0.13	33260G light, 33700 grommet
33060R	Hardwired	Hardwired	.180 Bullet	Red	PC	Black	12	0.13	33260R light, 33700 grommet
33060Y	Hardwired	Hardwired	.180 Bullet	Yellow	PC	Black	12	0.13	33260Y light, 33700 grommet

## SUPER 33, LED, 1 DIODE, 0.75", FLANGE MOUNT, KIT



- Excellent choice for interior applications such as truck cab, walkways, glove boxes, step lights, puddle lights and more
- Creates additional options for improving custom look and theme of vehicle exteriors, mounted on separate switch
- Hardwired lamp design easily retrofitted
- Low profile reduces damage from impact
- LEDs draw less current, allowing more power for other vehicle requirements
- Reduces lighting costs due to physical damage and heat entrapment
- Electronics completely sealed in epoxy to resist corrosion and moisture
- Designed for auxiliary lamp use only
- US Patent #6612728
- Not recommended for marker/clearance purposes



Part Number	Lamp Connector	Plug Side 1	Plug Side 2	Lens Color	Lens Material	Mount Color	Volts	Amps	Kit Includes
33061B	Hardwired	Hardwired	.180 Bullet	Blue	PC	Black	12	0.13	33260B light, 33800 grommet
33061C	Hardwired	Hardwired	.180 Bullet	Clear	PC	Black	12	0.13	33260C light, 33800 grommet
33061G	Hardwired	Hardwired	.180 Bullet	Green	PC	Black	12	0.13	33260G light, 33800 grommet
33061PR	Hardwired	Hardwired	.180 Bullet	Purple	PC	Black	12	0.13	33260PR light, 33800 grommet
33061R	Hardwired	Hardwired	.180 Bullet	Red	PC	Black	12	0.13	33260R light, 33800 grommet
33061Y	Hardwired	Hardwired	.180 Bullet	Yellow	PC	Black	12	0.13	33260Y light, 33800 grommet
33062B	Hardwired	Hardwired	.180 Bullet	Blue	PC	Chrome	12	0.13	33260B light, 33810 grommet
33062C	Hardwired	Hardwired	.180 Bullet	Clear	PC	Chrome	12	0.13	33260C light, 33800 grommet
33062G	Hardwired	Hardwired	.180 Bullet	Green	PC	Chrome	12	0.13	33260G light, 33810 grommet
33062R	Hardwired	Hardwired	.180 Bullet	Red	PC	Chrome	12	0.13	33260R light, 33810 grommet
33062Y	Hardwired	Hardwired	.180 Bullet	Yellow	PC	Chrome	12	0.13	33260Y light, 33810 grommet

## 36 SERIES, LED, 3 DIODE, 1" X 2", ADHESIVE MOUNT



- Provides robust LED white lighting solution that does not require mounting brackets or installation screws
- Light adheres directly to mounting surface with heavy-duty adhesive backing, with an easy-to-install, peel-off liner
- OmniVolt design makes the 36 Series auxiliary light perfect for any type of vehicle system
- Small profile makes it ideal for interior, tool box, storage, under cabinet, and other small spaces
- Perfect for rock lights in off-road application
- Electronics are completely sealed in epoxy to resist damage caused by moisture, corrosion, shock and vibration

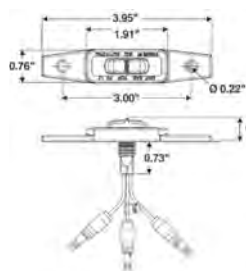

36214C / 36215C

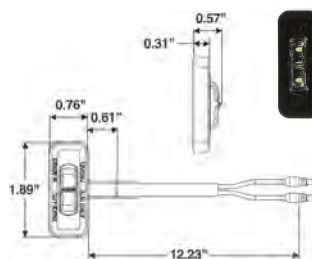

36204C / 36205C

Part Number	Lamp Connector	Plug Side 1	Plug Side 2	Lens Color	Lens Material	Mount Color	Volts	Amps	Wire Location
36204C	Hardwired	Hardwired	.180 Bullet	Clear	PC	Black	12 24	0.05	Rear Exit
36205C	Hardwired	Hardwired	.180 Bullet	Clear	PC	Black	12 24	0.05	Side Exit
36214C	Hardwired	Hardwired	.180 Bullet	Clear	PC	Black	12 24	0.05	Rear Exit
36215C	Hardwired	Hardwired	.180 Bullet	Clear	PC	Black	12 24	0.05	Side Exit

### 44<sup>®</sup> SERIES, LED, 54 DIODE, 4" , GROMMET MOUNT

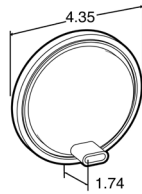

- Popular in trailer and body applications
- 85% reduction of load on electrical system allows more power for other vehicle requirements
- Virtually impervious to shock and vibration



Part Number	Lamp Connector	Plug Side 1	Plug Side 2	Lens Color	Lens Material	Volts	Amps
44207C	Fit 'N Forget S.S.	No Plug	No Plug	Clear	PC	12	0.11

### 44<sup>®</sup> SERIES, LED, 54 DIODE, 4" , GROMMET MOUNT, KIT

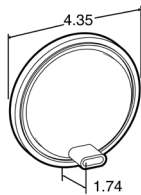

- Popular in trailer and body applications
- 85% reduction of load on electrical system allows more power for other vehicle requirements
- Virtually impervious to shock and vibration



Part Number	Lamp Connector	Plug Side 1	Plug Side 2	Lens Color	Lens Material	Mount Color	Volts	Amps	Kit Includes
44042C	Fit 'N Forget S.S.	Fit 'N Forget S.S.	Female PL-2	Clear	PC	Black	12	0.11	44307C light, 40700 grommet, 94789 plug

### 44<sup>®</sup> SERIES, LED, 54 DIODE, 4" , FLANGE MOUNT



- Popular in trailer and body applications
- 85% reduction of load on electrical system allows more power for other vehicle requirements
- Virtually impervious to shock and vibration



Part Number	Lamp Connector	Plug Side 1	Plug Side 2	Lens Color	Lens Material	Mount Color	Volts	Amps
44237C	Fit 'N Forget S.S.	No Plug	No Plug	Clear	PC	Gray	12	0.11

### 44<sup>®</sup> SERIES, LED, 6 DIODE, 4" , GROMMET MOUNT, KIT

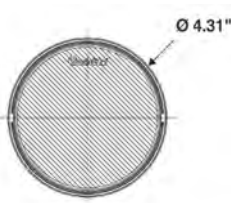

- Virtually impervious to shock and vibration



Part Number	Lamp Connector	Plug Side 1	Plug Side 2	Lens Color	Lens Material	Mount Color	Volts	Amps	Kit Includes
44057C	Hardwired	Hardwired	.180 Bullet	Clear	PC	Black	12	0.54	44308C light, 40700 grommet

LED  
44 SERIES

LED  
44 SERIES

LED  
44 SERIES

LED  
44 SERIES

LED



## SUPER 44<sup>®</sup>, LED, 6 DIODE, 4", GROMMET MOUNT



- Low-profile lamp, approximately 1" deep for where space is at a premium
- Features robust and cost-effective design
- Virtually impervious to shock and vibration
- Epoxy-encapsulated electronics protect the lamp from damage caused by chemicals and moisture
- Designed to operate in extremely cold temperatures
- Broad light pattern with approximately 360 lumens of light output
- U.S. Registered TM #3483147

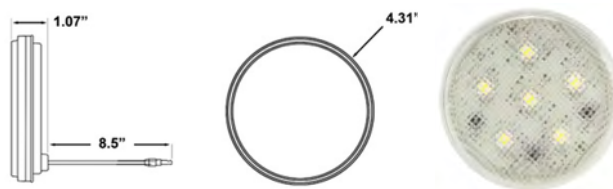

Part Number	Lamp Connector	Plug Side 1	Plug Side 2	Lens Color	Lens Material	Volts	Amps
44308C	Hardwired	Hardwired	.180 Bullet	Clear	PC	12	0.54

## SUPER 44<sup>®</sup>, LED, 6 DIODE, 4", FLANGE MOUNT



- Surface-mount design eliminates the need for large hole cutouts in trailer ceiling
- White housing design blends well with refrigerated trailer interiors
- Available with integrated on/off switch as well as externally controlled version
- Lens design recesses lens into housing to prevent damage from impact
- Not affected by cold temperatures, providing flicker-free lighting with a faster start-up time
- Ideal for refrigerated vehicles or those operating in cold weather
- Solid-state LED design is impervious to damage from shock and vibration
- Retrofit or replacement is quick and easy
- LED are fully encapsulated in epoxy to prevent damage caused by moisture and corrosives
- Recommend 3 #10 machine screws for mounting, with torque of 15-18 in-lbs

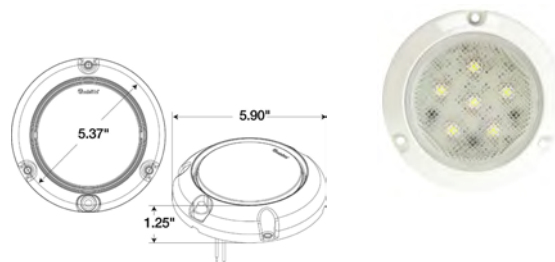

Part Number	Lamp Connector	Plug Side 1	Plug Side 2	Lens Color	Lens Material	Mount Color	Volts	Amps	Push Button Switch Y/N
44339C	Hardwired	Hardwired	.180 Bullet	Clear	PC	Gray	12	0.54	No
44439C	Hardwired	Hardwired	Stripped End	Clear	PC	White	12	0.54	No
44438C	Hardwired	Hardwired	Stripped End	Clear	PC	White	12	0.54	Yes
44352C	Hardwired	Hardwired	.180 Bullet	Clear	PC	White	12	0.54	No

## 80 SERIES, LED, 6 DIODE, 2" x 5", 4 SCREW BRACKET MOUNT

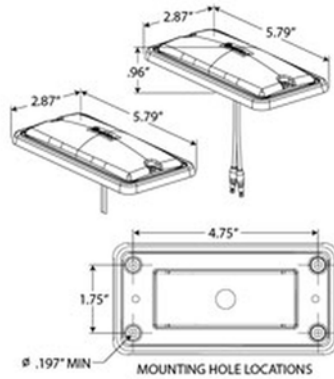

- U.S. Patent #7244058
- Die-cast aluminum housing
- White powder-coat finish
- Polycarbonate lens
- 10 White, 1W LEDs
- Lower profile than competitor lamps
- Nearly flush-mount, only .1" protrusion
- Not affected by cold temperatures
- LEDs provide whiter, brighter light
- Retrofit or replacement is quick and easy
- Flicker-free lighting in all temperatures



Part Number	Lamp Connector	Plug Side 1	Plug Side 2	Lens Color	Lens Material	Mount Color	Volts	Amps
80162C	Hardwired	Hardwired	Stripped End	Clear	PC	Black	12	0.38
80163C	Hardwired	Hardwired	Packard Connector	Clear	PC	Black	12	0.38
80164C	Hardwired	Hardwired	.180 Bullet	Clear	PC	Black	12	0.38

## 80 SERIES, LED, 6 DIODE, 6" x 16", 8 SCREW BRACKET MOUNT



- Patent Pending
- Not affected by cold temperatures
- LEDs provide whiter, brighter light
- Rugged aluminum housing and polycarbonate lens
- Electronics sealed in a conformal coating
- Weighs only 2 pounds
- Exclusive OmniVolt technology
- Standard size makes retrofit or replacement quick and easy



Part Number	Lamp Connector	Plug Side 1	Plug Side 2	Lens Color	Lens Material	Mount Color	Volts	Amps
80250C	Hardwired	Hardwired	Stripped End	Clear	PC	White	12 24	1.15

## 80 SERIES, LED, 10 DIODE, 2" x 13", 8 SCREW BRACKET MOUNT



- U.S. Patent #7244058
- Die cast aluminum housing
- White Powder coat finish
- Polycarbonate lens
- 10 White 1W LEDs
- Lower profile than competitive lamps
- Nearly flush mount, only .1" protrusion
- Not affected by cold temperatures
- LEDs provide whiter, brighter light
- Retrofit or replacement is quick and easy
- Flicker-free lighting in all temperatures



Part Number	Lamp Connector	Plug Side 1	Plug Side 2	Lens Color	Lens Material	Mount Color	Volts	Amps
80162C	Hardwired	Hardwired	Stripped End	Clear	PC	Black	12	0.38

## 80 SERIES, LED, 10 DIODE, 3" x 16", 8 SCREW BRACKET MOUNT



- Robust LED dome lamp w/motion sensor located in center of lamp to power lamp on
- Motion sensor determined by changes in heat and stays on through 5 minutes of inactivity
- Recognizes movement up to 10 feet away from lamp surface
- Nearly flush-mount design, with only .1 inch protrusion to allow more room in vehicle body
- Not affected by cold temperatures, providing flicker-free lighting with a faster start-up time
- Ideal for refrigerated vehicles or those operating in cold weather
- LEDs provide whiter, brighter light rated at 1,000 lumens, providing clearer, improved visibility
- Solid-state LED design is impervious to damage from shock and vibration
- Retrofit or replacement is quick and easy, with a standard 16x4 cut-out necessary for installation
- LEDs are fully encapsulated in epoxy to prevent damage caused by moisture and corrosives
- Hardwired design

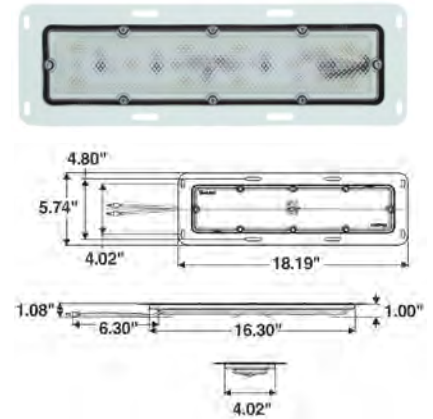

Part Number	Lamp Connector	Plug Side 1	Plug Side 2	Lens Color	Lens Material	Mount Color	Volts	Amps	Motion Sensor
80253C	Hardwired	Hardwired	.180 Bullet	Clear	PC	White	12	2	No
80255C	Hardwired	Hardwired	.180 Bullet	Clear	PC	White	12	2	Yes

## 84 SERIES, LED, 12 DIODE, 2" x 48", 4 SCREW BRACKET MOUNT



- LED light source provides more even truck cargo light
- Aluminum housing won't rust
- Less susceptible to shock and vibration
- Reduces shadowed areas and increases visibility
- Can be mounted almost anywhere
- LEDs draw less current, creating less heat
- Designed for interior use only



Part Number	Lamp Connector	Plug Side 1	Plug Side 2	Lens Color	Lens Material	Mount Color	Volts	Amps	Notes
84200C	Hardwired	Hardwired	.180 Bullet	Clear	PC	White	12	1.27	4 in corner

## SIGNAL-STAT, LED, 4 DIODE, 3" x 10", 2 SCREW BRACKET MOUNT



- Ideal for flood, cargo, step, locker and overhead lighting
- Can be fitted in semi-trailer, trailer, box van, mini-bus/coach, emergency services, utilities, recovery and load-handling vehicles
- Utilizes an extremely reliable slimline design and combines both dual-voltage and dual-polarity functions
- Instant switch on with easy surface mount and offset optical design making it easy to position in any orientation to direct light to the desired area
- Low-profile, waterproof to IP67 and reliable to a temperature of minus 40° C
- ECE-approved LED interior lamp to ECE 95/54, EEC 2000/2, ECE Reg. 10

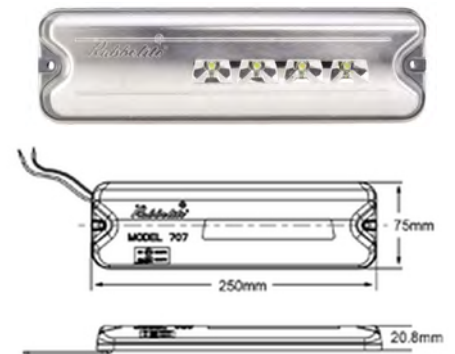

Part Number	Lamp Connector	Plug Side 1	Plug Side 2	Lens Color	Lens Material	Mount Color	Volts	Amps
8013	Hardwired	Hardwired	Blunt Cut	Clear	PC	Gray	12 24	1.15

## 10<sup>®</sup> SERIES, INCANDESCENT, 1 BULB, 2.5", GROMMET MOUNT



- Lens and housing are sonically sealed
- High-impact polycarbonate construction
- 15,000 hour rated bulb life
- Replaces Signal-Stat 1010W



Part Number	Lamp Connector	Lens Color	Lens Material	Volts	Amps
10202C	PL-10	Clear	PC	12	0.33
10204C	PL-10	Clear	PC	24	0.17

## SUPER 10<sup>®</sup> SERIES, INCANDESCENT, 1 BULB, 2.5", GROMMET MOUNT



- Lens and housing are sonically sealed
- High-impact polycarbonate construction
- 15,000 hour rated bulb life
- Replaces Signal-Stat 1010W



Part Number	Lamp Connector	Lens Color	Lens Material	Volts	Amps
10209C	PL-10	Clear	PC	12	0.33

INCANDESCENT

10 SERIES

INCANDESCENT

10 SERIES

## 12<sup>®</sup> SERIES, INCANDESCENT, 1 BULB, 2" x 3", BRACKET MOUNT



- Standard replacement for UPS
- Sonically sealed lens and housing
- 15,000 rated 12V bulb life
- 12V and 24V models
- Suitable for PC requirements when mounted horizontally on a 45-degree angle
- Optional mounting gasket to improve seal between lamp and body

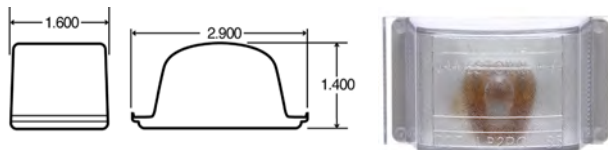

Part Number	Lamp Connector	Lens Color	Lens Material	Volts	Amps
12200C	PL-10	Clear	PC	12	0.33

INCANDESCENT

12 SERIES

## 15<sup>®</sup> SERIES, INCANDESCENT, 1 BULB, 1" x 2", BRACKET MOUNT



- High-impact polycarbonate sonically sealed lens and housing
- Features 15,000 hour long-life bulb
- Replaces Signal-Stat 1500W

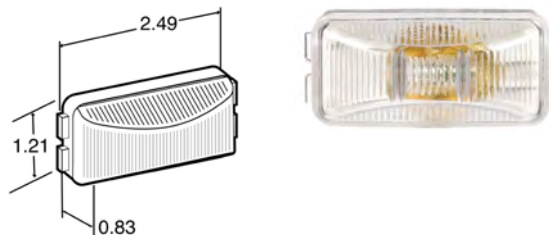

Part Number	Lamp Connector	Lens Color	Lens Material	Volts	Amps
15200C	PL-10	Clear	PC	12	0.33

INCANDESCENT

15 SERIES

## 19<sup>®</sup> SERIES, INCANDESCENT, 2 BULB, 1" x 4", BRACKET MOUNT



- High-impact polycarbonate sonically sealed lens and housing
- Features 15,000 hour long-life bulb

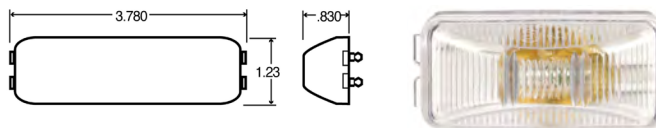

Part Number	Lamp Connector	Lens Color	Lens Material	Volts	Amps
19200C	19 Series Male Pin	Clear	PC	12	0.33

INCANDESCENT

19 SERIES

INCANDESCENT

20 SERIES

## 20 SERIES, INCANDESCENT, 1 BULB, 2", 2 SCREW BRACKET MOUNT

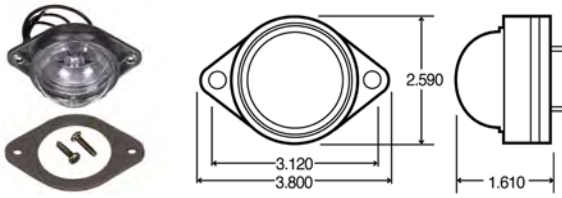

- Features beehive profile lens which produces maximum 90-degree edge lighting
- Snap-in lens for quick and easy replacement
- Utility lamp, #20308 not intended for dome lamp use



Part Number	Lamp Connector	Plug Side 1	Plug Side 2	Lens Color	Lens Material	Mount Color	Volts	Amps
20302	Hardwired	Hardwired	Stripped End	Clear	PC	Silver	12	0.97
20308	Hardwired	Hardwired	.180 Bullet	Clear	PC	Silver	12	2.1

INCANDESCENT

26 SERIES

## 26 SERIES, INCANDESCENT, 1 BULB, BRACKET MOUNT, KIT

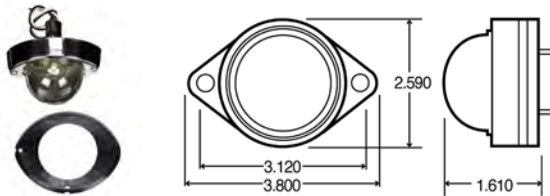

- Stainless steel housing will not rust or corrode
- Glass lens holds up to extreme temperatures
- Mounts with two # 10 screws on 1.625" centers
- Mounting hole requires 13/16" diameter cutout



Part Number	Lamp Connector	Plug Side 1	Plug Side 2	Lens Color	Lens Material	Mount Color	Volts	Amps	
26391C	Hardwired	Hardwired	Stripped End	Clear	Glass	Silver	24	1.2	
26392C	Hardwired	Hardwired	Stripped End	Clear	Glass	Silver	24	1.2	w/ground wire
26393C	Hardwired	Hardwired	Stripped End	Clear	Glass	Silver	12	1.43	
26394C	Hardwired	Hardwired	Stripped End	Clear	Glass	Silver	12	1.43	w/ground wire

INCANDESCENT

30 SERIES

## 30<sup>®</sup> SERIES, INCANDESCENT, 1 BULB, 2", 2 SCREW BRACKET MOUNT



- High-impact polycarbonate construction
- Lens and housing are sonically sealed
- 15,000 hour rated 12V bulb life
- Replaces Signal-Stat 1030W



Part Number	Lamp Connector	Plug Side 1	Plug Side 2	Lens Color	Lens Material	Mount Color	Volts	Amps
30200C	PL-10	No Plug	No Plug	Clear	PC		12	0.33
30206C	PL-10	No Plug	No Plug	Clear	PC		24	0.17

## 40<sup>®</sup> SERIES, INCANDESCENT, 1 BULB, 4", GROMMET MOUNT



- Popular option on new Wabash trailers
- Uniquely designed shock mount extends lamp life
- For auxiliary use only
- Specially designed lens allows lamp to angle light away from trailer rather than straight back
- Output light up to 10' on sides at a 45 degree angle
- Illuminates area seen by driver through side mirrors

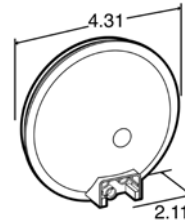

Part Number	Lamp Connector	Plug Side 1	Plug Side 2	Lens Color	Lens Material	Volts	Amps	
40203	PL-2	No Plug	No Plug	Clear	PC	12	1.44	Angled Illumination
40207	PL-2	No Plug	No Plug	Clear	PC	12	2.1	Angled Illumination
40211	PL-2	No Plug	No Plug	Clear	PC	12	1.44	Clear Back
40227	PL-2	No Plug	No Plug	Clear	PC	12	1.44	w/Epoxy Fill

## 40<sup>®</sup> SERIES, INCANDESCENT, 1 BULB, 4", GROMMET MOUNT, KIT



- Features clear back housing
- Sealed polycarbonate lens and housing
- Grommet kit features flush mounting in a 4 1/2" hole

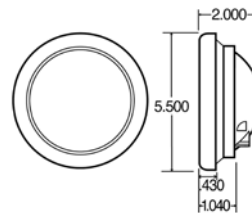

Part Number	Lamp Connector	Plug Side 1	Plug Side 2	Lens Color	Lens Material	Mount Color	Volts	Amps	Kit Includes
40003	PL-2	PL-2	Stripped End/Ring Terminal	Clear	PC	Black	12	1.44	40203 light, 40700 grommet, 94922 plug
40011	PL-2	PL-2	Stripped End/Ring Terminal	Clear	PC	Black	12	1.44	40211 light, 40703 grommet, 94961 plug

## 40<sup>®</sup> SERIES, INCANDESCENT, 1 BULB, 4", FLANGE MOUNT

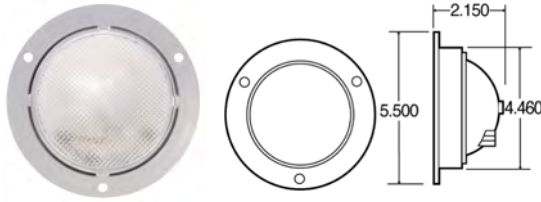

- Polycarbonate lens and housing are sonically sealed
- Bulb is shock-mounted for extended life
- Upgrade to LED lighting systems using Truck-Lite's Super 44 Series



Part Number	Lamp Connector	Plug Side 1	Plug Side 2	Lens Color	Lens Material	Mount Color	Volts	Amps
40223	PL-2	No Plug	No Plug	Clear	PC	Gray	12	1.44

## 40<sup>®</sup> SERIES, INCANDESCENT, 1 BULB, 4", FLANGE MOUNT, KIT

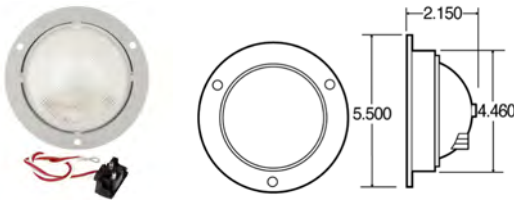

- Polycarbonate lens and housing are sonically sealed
- Bulb is shock-mounted for extended life
- Upgrade to LED lighting systems using Truck-Lite's Super 44 Series



Part Number	Lamp Connector	Plug Side 1	Plug Side 2	Lens Color	Lens Material	Mount Color	Volts	Amps	Kit Includes
40023	PL-2	PL-2	Stripped End/ Ring Terminal	Clear	PC	Gray	12	1.44	40223 light, 94992 grommet

## INCANDESCENT, 1 BULB, 1", ROUND, 2 SCREW, BRACKET MOUNT

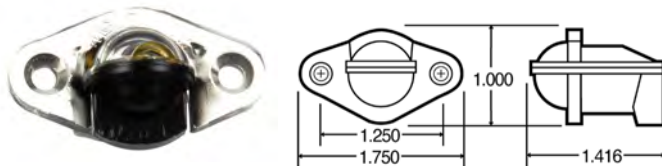

- Variety of interior and exterior applications
- Compact sealed polycarbonate construction



Part Number	Lamp Connector	Plug Side 1	Plug Side 2	Lens Color	Lens Material	Mount Color	Volts	Amps
04116	PL-10	No Plug	No Plug	Clear	PC	Clear	12	0.33

INCANDESCENT

40 SERIES

INCANDESCENT

40 SERIES

INCANDESCENT

1 BULB



## INCANDESCENT, 1 BULB, 1", ROUND, 2 SCREW BRACKET MOUNT, KIT



- Variety of interior and exterior applications
- Sealed polycarbonate construction

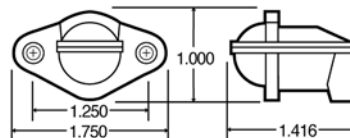

Part Number	Lamp Connector	Plug Side 1	Plug Side 2	Lens Color	Lens Material	Mount Color	Volts	Amps	Kit Includes
04115	PL-10	No Plug	No Plug	Clear	PC	Clear	12	0.33	
26001	PL-10	PL-10	Stripped End/Ring Terminal	Clear	PC	Clear	12	0.33	94854 plug

## INCANDESCENT, 1 BULB, 2" x 5", RECTANGULAR, 2 SCREW BRACKET MOUNT



- Designed for easy recessed mount replacement
- Features plated steel housing and acrylic lens
- Lens held by two screws for easy bulb replacement
- Requires 4-3/16" X 1-5/8" cut-out

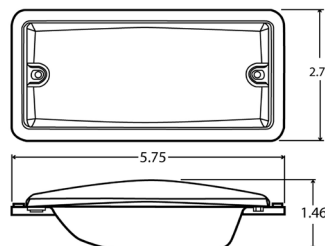

Part Number	Lamp Connector	Plug Side 1	Plug Side 2	Lens Color	Lens Material	Mount Color	Volts	Amps
80490	Hardwired	Hardwired	Stripped End	Clear	Acrylic	Silver	12	0.94

## INCANDESCENT, 1 BULB, 3" x 7", RECTANGULAR, 2 SCREW BRACKET MOUNT



- Flush mounts on two screws at 6.0" centers
- Requires a 2" x 5-1/4" hole
- Grounds through mounting screws
- Functions as an interior dome, a compartment or utility lamp
- Heavy-duty steel and acrylic construction

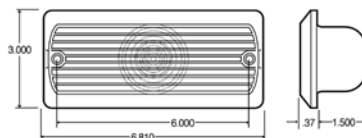

Part Number	Lamp Connector	Plug Side 1	Plug Side 2	Lens Color	Lens Material	Volts	Amps
81350	Hardwired	Hardwired	Stripped End	Clear	Acrylic	12	1.04

INCANDESCENT

1 BULB

INCANDESCENT

1 BULB

INCANDESCENT

1 BULB

## SIGNAL-STAT, INCANDESCENT, 1 BULB, 2" x 5", 2 SCREW BRACKET MOUNT

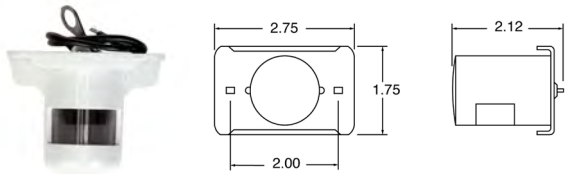

- Twist-off lens hood for easy bulb replacement
- Lights up instrument panel and compartments
- Surface mounts on 2" centers
- Grounds through mounting screws
- Polycarbonate housing will not rust



Part Number	Lamp Connector	Plug Side 1	Plug Side 2	Lens Color	Lens Material	Mount Color	Volts	Amps
433WD	Hardwired	Hardwired	Stripped End/Ring Terminal	Clear	Acrylic	White	12	0.35

## SIGNAL-STAT, INCANDESCENT, 1 BULB, 1" x 2", 2 SCREW BRACKET MOUNT

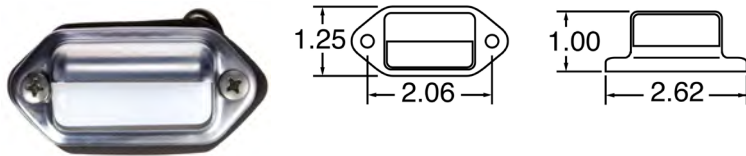

- Focused light output
- Hooded guard to stop glare
- Separate ground wire



Part Number	Lamp Connector	Plug Side 1	Plug Side 2	Lens Color	Lens Material	Mount Color	Volts	Amps
434WD	Hardwired	Hardwired	Stripped End	Clear	Acrylic	Chrome	12	0.27

## SIGNAL-STAT, INCANDESCENT, 1 BULB, 2" x 6", 2 SCREW BRACKET MOUNT



- Navistar replacement
- Use for dome or utility lamp
- Surface mount for easy installation



Part Number	Lamp Connector	Plug Side 1	Plug Side 2	Lens Color	Lens Material	Mount Color	Volts	Amps
4094SW	PL-2	Female PL-2	Packard Connector	Clear	PC	White	12	1

INCANDESCENT

SIGNAL-STAT

INCANDESCENT

SIGNAL-STAT

INCANDESCENT

SIGNAL-STAT

## SIGNAL-STAT, INCANDESCENT, 1 BULB, 2" x 4", 4 SCREW BRACKET MOUNT



- Use for dome or utility lamp
- Raised lens for maximum output
- Surface mount for easy installation

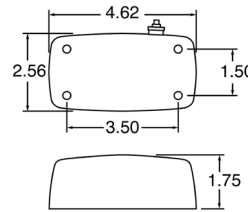

Part Number	Lamp Connector	Plug Side 1	Plug Side 2	Lens Color	Lens Material	Mount Color	Volts	Amps
549SWD	Hardwired	Hardwired	Stripped End	Clear	PC	Silver	12	2.1

INCANDESCENT

SIGNAL-STAT

## SIGNAL-STAT, INCANDESCENT, 2 BULB, 1" x 2", 2 SCREW BRACKET MOUNT



- Snap-in lens for easy bulb replacement
- Vulcanized rubber housing with aluminum base

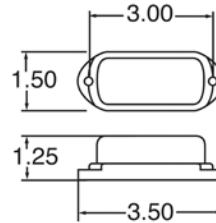

Part Number	Lamp Connector	Plug Side 1	Plug Side 2	Lens Color	Lens Material	Mount Color	Volts	Amps
1506W	Hardwired	Hardwired	Stripped End	Clear	Acrylic	Black	12	0.27

INCANDESCENT

SIGNAL-STAT

## SIGNAL-STAT, INCANDESCENT, 2 BULB, 2" x 4", 2 SCREW BRACKET MOUNT



- 15,000-hour bulbs
- Corrosion-proof Permastat housing
- Snap-on lens for easy bulb replacement

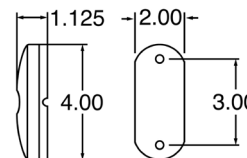

Part Number	Lamp Connector	Plug Side 1	Plug Side 2	Lens Color	Lens Material	Volts	Amps
1211W	Hardwired	Hardwired	Blunt Cut	Clear	Acrylic	12	0.27

INCANDESCENT

SIGNAL-STAT

FLUORESCENT

2 SCREW

## FLUORESCENT, 2 BULB, 5" x 18", 2 SCREW BRACKET MOUNT

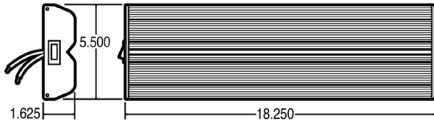

- High-impact snap-on polycarbonate lens
- Metal housing is white epoxy powder-coated
- Installation is easy with integrated 2-pin Packard connector
- Lamp plug connector mates with Packard connector #12129081
- Upgrade to LED lighting systems using Truck-Lite's 80 Series



Part Number	Lamp Connector	Plug Side 1	Plug Side 2	Lens Color	Lens Material	Mount Color	Volts	Amps
80444	Hardwired	Hardwired	Stripped End	Clear	Acrylic	Silver	12	2.2

FLUORESCENT

4 SCREW

## FLUORESCENT, 2 BULB, 6" x 21", 4 SCREW BRACKET MOUNT

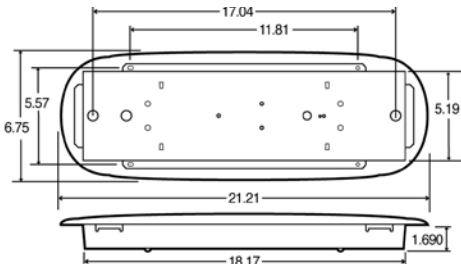

- Designed for heavy-use service vehicles such as industrial supply trucks, emergency vehicles or mobile kitchens
- Clear acrylic snap-lock lens
- Anodized aluminum housing features black end caps
- Two 15W fluorescent tubes produce light output of 1650 lumens
- Convenient on/off switch
- Upgrade to LED lighting systems using Truck-Lite 80 Series Products



Part Number	Lamp Connector	Plug Side 1	Plug Side 2	Lens Color	Lens Material	Mount Color	Volts	Amps
80418	Hardwired	Hardwired	Packard Connector 12129155	Clear	PC	White	12	2.2

# Looking for even more product information?

Visit [truck-lite.com](http://truck-lite.com)



**Powerful Search  
Function**



**360° Product  
Images**



**Easy-To-Find  
Replacement  
Parts**

# LIGHTING REPLACEMENT PARTS

## REPLACEMENT LENSES

Pages 310-318

SERIES	PAGES
Round	310-312
Oval	313-314
Rectangular	314-317
Square	318
Triangular	318
Beehive	318

## REPLACEMENT BULBS

Pages 320-324

SERIES	PAGES
Halogen	320-322
Incandescent	322-323
Strobe Tube	324

## STROBE MOTORS & ROTATORS

Page 325

## STROBE MOUNTING MAGNETS

Page 326

SERIES	PAGES
Steel	326
Rubber	326

## STROBE POWER SUPPLIES

Page 327

## FLASHER MODULES

Pages 328-335

SERIES	PAGES
Electro-Mechanical	328-330
Solid-State	331-333
Thermal	333
Connectors	334
DRL Systems	335

## RELAYS

Pages 336-337

SERIES	PAGES
5 Blade Terminal	336
4 Blade Terminal	337

### ROUND, 1", SNAP-FIT

Part Number	Lens Color	Compatible Parts
7332	Red	5040, 5040, 5040

### ROUND, 2", SNAP-FIT

Part Number	Lens Color	Compatible Parts
99005C	Clear	Dome & Utility (20302, 20308), Signal-Stat (9354 Series)
99005R	Red	20 Series Lamps, Signal-Stat (9354 Series)
99005Y	Yellow	Signal Lighting Lamps (20301Y, 20304Y, 20316Y), Signal-Stat (9354 Series)
99034R	Red	Do-Ray Lamps, Grote
99034Y	Yellow	Do-Ray Lamps, Grote
99035R	Red	26309R, 26318R, Do-Ray Lamps
99035Y	Yellow	26309Y, 26318Y, Do-Ray Lamps

### ROUND, 2", 2-SCREW

Part Number	Lens Color	Compatible Parts
99107Y	Yellow	Marker Lamps  Side Turn Signal (26390Y)

### ROUND, 3", SNAP-FIT

Part Number	Lens Color	Compatible Parts
99104R	Red Clear	80310R  Do-Ray Lamps
99105R	Red	80310R  Do-Ray Lamps
99001R	Red	8506R/Y-1  10300R/Y  10301R/Y
99001Y	Yellow	8506R/Y-1  10300R/Y  10301R/Y
99044R	Red	Betts Lamps
99044Y	Yellow	Betts Lamps
8909	Red	Stop/Turn/Tail Lamp (2110, 2112)
8943	Red	Cab Marker (1319)
8943A	Yellow	Cab Marker (1319A)
8943W	Clear	Cab Marker (1319)
8945	Red	M/C Lamps (1115, 1116)
8945A	Yellow	M/C Lamps (1115, 1116)
9076W	Clear	Back-up Lamps (92WD)
9081	Red	Cab Marker (GM 2004543)
9081A	Yellow	Cab Marker (GM 799386)

### ROUND, 3", THREADED FIT

Part Number	Lens Color	Compatible Parts
9719A	Yellow	Strobes (92560, 92563)

### ROUND, 4", SNAP-FIT

Part Number	Lens Color	Compatible Parts
99120B	Blue	Par 36 Sealed Beams (80373)
99120C	Clear	Par 36 Sealed Beams
99120R	Red	Par 36 Sealed Beams (80373)
99147Y	Yellow	Strobes (92504Y, 92505Y, 94Y, 99Y, 92534Y)
99007C	Clear	Most 4" Lamps
99007R	Red	Front, Rear Lighting (80302R), Most 4" Lamps
99007Y	Yellow	Front, Rear Lighting (80302Y), Most 4" Lamps
99009R	Red	Pedestal Lamps (70330R, 70300)
99009Y	Yellow	Pedestal Lamps (70330Y, 70300)
99090R	Red	Do-Ray Lamps, Pedestal Lamps (70310R, 70311, 70330R, 80329R)
99090Y	Yellow	Do-Ray Lamps, Pedestal Lamps (70310R, 70311, 70330Y, 80329R)
9029	Red	Snap Ring Lamps
8936	Red	Pedestal Lamps (677WK, 3753, 3754, 3755, 3756, 3850, 3853)
9029A	Yellow	Snap Ring Lamps
9029B	Blue	Snap Ring Lamps
8936A	Yellow	Pedestal Lamps (677WK, 3753, 3754, 3755, 3756, 3850, 3853AA)
9029W	Clear	Snap Ring Lamps
8936B	Blue	Pedestal Lamps (677WK, 3753, 3754, 3755, 3756, 3850, 3853)
9041	Red	3751, 3752, 3851, Front, Rear Lighting (540D, 541)
9041A	Yellow	3751, 3752, 3851, Front, Rear Lighting (540 Series)
9341	Red	Pedestal Lamps (3760, 3763, 3860, 3861, 3862, 3863, 3762)
9341A	Yellow	Pedestal Lamps (3760, 3763, 3860, 3861, 3862, 3863, 3762)
9341B	Blue	Pedestal Lamps (3760, 3763, 3860, 3861, 3862, 3863, 3762)
9341G	Green	Pedestal Lamps (3760, 3763, 3860, 3861, 3862, 3863, 3762)
9341W	Clear	Pedestal Lamps (3760, 3763, 3860, 3861, 3862, 3863, 3762)



**ROUND, 4", 2-SCREW**

Part Number	Lens Color	Compatible Parts
99066Y	Yellow	M/C Lamps (26760Y)
99083R	Red	80461R, 80462R, 80463R, Do-Ray Lamps, Pathfinder
8974	Red	2201, 2203, 2204

**ROUND, 4", 3-SCREW**

Part Number	Lens Color	Compatible Parts
9016	Red	Front, Rear Lighting (3612, 3616), Pedestal Lamps (3802, 3806, 3812, 2801, 2803, 3801, 3810, 3805Y115, 2701, 3701, 2702)
9016B	Blue	Pedestal Lamps
9016G	Green	Pedestal Lamps
9016A	Yellow	Pedestal Lamps (3802, 3806, 3812, 2801, 2803, 3801, 3810, 2701A, 2702A)
9021	Red	Front, Rear Lighting (3612, 3616), Pedestal Lamps (3802, 3806, 3812, 2801, 2803, 3801, 3810, 3805Y115, 2701, 3701)
9016W	Clear	Front, Rear Lighting (3613W), License Lamps (3693W, 3691W)
9021A	Yellow	Pedestal Lamps (3802, 3806, 3812, 2801, 2803, 3801, 3810, 2701A)
9021W	Clear	Front, Rear Lighting (3613W), License Lamps (3693W C, 3691W C)

**ROUND, 4", THREADED FIT**

Part Number	Lens Color	Compatible Parts
9720A	Yellow	Strobes (300A L, 301A L, 307A P)
9720	Red	Strobes (307R)
9720B	Blue	Strobes (307B)
9720W	Clear	Beacons, LED Strobes

**ROUND, 5", SNAP-FIT**

Part Number	Lens Color	Compatible Parts
99101R	Red	Betts Lamps
99008C	Clear	License Lamps (80342, 80344, 80345)  Most 4" Lamps
99008R	Red	Front, Rear Lighting (80334R, 80339R, 81301R)  Most 4" Lamps
99008Y	Yellow	Front, Rear Lighting (81300Y)  Most 4" Lamps
99010C	Clear	Back-up Lamps (40306)
99010R	Red	Front, Rear Lighting (40302R, 40318R)
99010Y	Yellow	Front, Rear Lighting (40302Y, 40318Y)
8919	Red	Signal Lighting Lamps (4710)
8919A	Yellow	Signal Lighting Lamps (4710)
8935W	Clear	Universal Dome (9380W)

**ROUND, 5", 2-SCREW**

Part Number	Lens Color	Compatible Parts
99176C	Clear	Dome, Utility (80423C Hook-up Lamps)
99150C	Clear	Light Bars (92520Y, 92521Y, 92522Y, 92523Y, 92524Y, 92525Y)

**ROUND, 5", THREADED FIT**

Part Number	Lens Color	Compatible Parts
99080C	Clear	Dome & Utility (80350, 80351, 80352, 80353), Do-Ray Lamps
99082C	Clear	Dome & Utility (80350, 80352), Do-Ray Lamps
99082R	Red	Dome & Utility (80350, 80351), Do-Ray Lamps

## ROUND, 6", SNAP-FIT

Part Number	Lens Color	Compatible Parts
99108Y	Yellow	Strobe (92351Y, 92531Y, 92530Y)
40270C	Clear	0.05" Aluminum Sheets, Dome & Utility Lamps
40271C	Clear	0.31" Composite Panels, Dome & Utility Lamps
40275C	Clear	0.25" Composite Panels, Dome & Utility Lamps
9723A	Yellow	Beacons (6822A, 6823A)

## ROUND, 6", 2-SCREW

Part Number	Lens Color	Compatible Parts
9705A	Yellow	Strobes (6600, 6610, 6800, 6810)
9705B	Blue	Strobes (6600, 6610, 6800, 6810)
9705R	Red	Strobes (6600, 6610, 6800, 6810)
9705W	Clear	Strobes (6600, 6610, 6800, 6810)
9710R	Red	Strobes (6601, 6611, 6801, 6811)
9710W	Clear	Strobes (6601, 6611, 6801, 6811)

## ROUND, 6", 3-SCREW

Part Number	Lens Color	Compatible Parts
99074R	Red	Box Lamps (80322R, 80324R)
99145C	Clear	Strobes (92513C)
99145Y	Yellow	Strobes (92500Y, 92506Y, 92513Y, 92502Y, 92508Y, 92515Y, 92501Y, 92507Y, 92514Y)

## ROUND, 6", THREADED FIT

Part Number	Lens Color	Compatible Parts
99220Y	Yellow	Strobes (92572Y, 6811A, 6811MA, 6601A, 6601MA, 92860Y LED, 92861Y LED)
99221Y	Yellow	Strobes (92862Y LED, 92863Y LED, 92573Y, 6600A, 6600MA, 6810A, 6810MA)
99220B	Blue	Strobes & Beacons (6811B, 6601B)
99220R	Red	Strobes & Beacons (6811R, 6601R)
99221B	Blue	Strobes & Beacons (6600B, 6810B)
99221R	Red	Strobes & Beacons (6600R, 6810R)
99221W	Clear	Strobes & Beacons (6600W, 6810W)
99220W	Clear	Strobes (92572Y, 6811A, 6811MA, 6601A, 6601MA, 92860Y LED, 92861Y LED)

## ROUND, 7", 4-SCREW

Part Number	Lens Color	Compatible Parts
99167Y	Yellow	Bus Lamps (90325Y, 6505)
99168C	Clear	Bus Lamps (6504, 90327R/Y), Signal-Stat (6503)
99168R	Red	Bus Lamps (90327R, 6503, 6504)
99168Y	Yellow	Bus Lamps (90327Y, 6503A, 6504)
99169R	Red	Bus Lamps (90326R, 6507)
99169Y	Yellow	Bus Lamps (90326Y, 6507)
99021R	Red	Bus Lamps (91312R, 91812R, 91315R)
99021Y	Yellow	Bus Lamps (91312Y, 91812Y)
99088C	Clear	Dome & Utility (80354, 80355, 80356, 80357, 90320R/Y, 90321R/Y)
99088R	Red	Lamps (80354, 80355, 90320R/Y, 90321R/Y)

## ROUND, 7", THREADED FIT

Part Number	Lens Color	Compatible Parts
99250C	Clear	Strobes & Beacons (92565C, 92568C, 92592Y)
99250Y	Yellow	Strobes & Beacons (92569Y, 92565Y, 92566Y, 92568Y)
99252C	Clear	Strobes & Beacons (92564C)
99252Y	Yellow	Strobes & Beacons (92564Y)
99250B	Blue	Strobes & Beacons (92565B, 92568B)

## ROUND, 8", 2-SCREW

Part Number	Lens Color	Compatible Parts
99143C	Clear	Strobes (92500Y, 92506Y, 02513Y, 92513C)
99143Y	Yellow	Strobe (92600Y)

**OVAL, 1" X 3", SNAP-FIT**

Part Number	Lens Color	Compatible Parts
8946	Red	M/C Lamps (1505, 1506)
8946A	Yellow	M/C Lamps (1505A, 1506A)
8946W	Clear	M/C Lamps (1505W, 1506W)
9061A	Yellow	M/C Lamps (1550, 1551)

**OVAL, 1" X 4", SNAP-FIT**

Part Number	Lens Color	Compatible Parts
99041R	Red	Do-Ray Lamps, Grote, Signal-Stat
99041Y	Yellow	Do-Ray Lamps, Grote, Signal-Stat
99050R	Red	Do-Ray Lamps, M/C Lamps (26312R, 26317R)
99050Y	Yellow	Do-Ray Lamps, M/C Lamps (26312Y, 26317Y)
99051R	Red	M/C Lamps (26310R)
99051Y	Yellow	M/C Lamps (26310Y)
8937	Red	M/C Lamps (1555)
8937A	Yellow	M/C Lamps (1555A)

**OVAL, 2" X 3", 1-SCREW**

Part Number	Lens Color	Compatible Parts
8977A	Yellow	Dietz 2-18 Series
9087	Red	Cab Markers (1312A)
9087A	Yellow	Cab Markers (1312)

**OVAL, 2" X 4", SNAP-FIT**

Part Number	Lens Color	Compatible Parts
99027Y	Yellow	26 Series PC Rated Bulb (26902Y)
99043R	Red	Betts Lamps  Do-Ray
99043Y	Yellow	Betts Lamps  Do-Ray
8933	Red	M/C Lamps (1263, 1264)
8933A	Yellow	Economy Mirrors (97628, 97629, 97627, 97630, 97631)  M/C Lamps (1263, 1264A)
9007A	Yellow	M/C Lamps (1201, 1203, 1204, 1211A, 1213A, 1215, 1216A, 1253)
9007B	Blue	M/C Lamps (1201, 1203, 1204, 1211, 1213, 1215, 1216, 1253)
9007G	Green	M/C Lamps (1201, 1203, 1204, 1211, 1213, 1215, 1216, 1253)
9007W	Clear	M/C Lamps (1201, 1203, 1204, 1211, 1213, 1215, 1216, 1253)
9006	Red	M/C Lamps (1201, 1203, 1204)
9006A	Yellow	M/C Lamps (1201, 1203A, 1204)
9093	Red	M/C Lamps (1258, 1259, 1262)
9093A	Yellow	M/C Lamps (1258, 1259A, 1262)
9093B	Blue	M/C Lamps (1258, 1259B, 1262)
9093G	Green	M/C Lamps (1258, 1259, 1262)
9093W	Clear	M/C Lamps (1258, 1259, 1262)

**OVAL, 2" X 5", 1-SCREW**

Part Number	Lens Color	Compatible Parts
99067R	Red	Cab Marker (26765Y, 1320, 1320AD, 1320A, Signal-Stat 9067/A)
99067Y	Yellow	Cab Marker (26765Y, 1320, 1320AD, 1320A, Signal-Stat 9067/A)

**OVAL, 2" X 6", 2-SCREW**

Part Number	Lens Color	Compatible Parts
9077	Red	M/C Lamps (1233, 1235, 1205)
9077A	Yellow	M/C Lamps (1233A, 1235, 1205)
9077W	Clear	M/C Lamps (1205, 1233, 1235)
99011R	Red	Front, Rear Lighting (60302R)
99011Y	Yellow	Lamps (60 Series)

REPLACEMENT LENSES

### OVAL, 2" X 7", SNAP-FIT

Part Number	Lens Color	Compatible Parts
99184C	Clear	Dome & Utility (60340R/Y, 60345C, 60834C)
99184R	Red	Front, Rear Lighting (60340R, 60345C, 60834C, 60344R)
99184Y	Yellow	Front, Rear Lighting (60340Y, 60345C, 60834C, 60344Y)

OVAL

### OVAL, 3" X 5", SNAP-FIT

Part Number	Lens Color	Compatible Parts
9001	Red	502, 505, 510

RECTANGULAR

### OVAL, 3" X 7", 1-SCREW

Part Number	Lens Color	Compatible Parts
80572	Clear	Headlamps-Fog & Driving Lamps (80520)
80573	Clear	Headlamps-Fog & Driving Lamps (80521)
80574	Yellow	Headlamps-Fog & Driving Lamps (80522)

### OVAL, 5" X 7", 3-SCREW

Part Number	Lens Color	Compatible Parts
99158Y	Yellow	92620Y

### OVAL, 7" X 21", SNAP-FIT

Part Number	Lens Color	Compatible Parts
99175C	Clear	Dome & Utility (80418)

### OVAL, 8" X 16", SNAP-FIT

Part Number	Lens Color	Compatible Parts
99200Y	Yellow	Beacons  Light Bars (92642Y, 92643Y, 92644Y, 92645Y, 92645Y, 92646Y)
99200C	Clear	Light Bars

### RECTANGULAR, 1" X 2", SNAP-FIT

Part Number	Lens Color	Compatible Parts
99160C	Clear	M/C Lamps (26311, 26313)  Signal Stat Lamps (1113, 1114)
9082	Red	M/C Lamps (1520, 1520HT, 1521, 1523)
9082A	Yellow	M/C Lamps (1520A, 1520 AHT, 1521, 1523)
9342	Red	M/C Lamps (1507)
9342A	Yellow	M/C Lamps (1507A)

### RECTANGULAR, 1" X 3", SNAP-FIT

Part Number	Lens Color	Compatible Parts
9005	Red	M/C Lamps (1101, 1102, 1105, 1108, 9365, 9366, 9369)
9005A	Yellow	M/C Lamps (1101, 1102, 1105, 1108, 9365, 9366, 9369)
9005W	Clear	M/C Lamps (1101, 1102, 1105, 1108, 9365, 9366, 9369)
9059	Red	M/C Lamps (1550, 1551)
9059A	Yellow	M/C Lamps (1550, 1551)
9059W	Clear	M/C Lamps (1550, 1551)
9061	Red	M/C Lamps (1550, 1551)

### RECTANGULAR, 1" X 6", SNAP-FIT

Part Number	Lens Color	Compatible Parts
8918	Red	Signal Lighting Lamps (4091)
8918A	Yellow	Signal Lighting Lamps (4091A)

**RECTANGULAR,  
1" X 23", SNAP-FIT**

Part Number	Lens Color	Compatible Parts
99233C	Clear	Dome & Utility (84206C)
99234C	Clear	Dome & Utility (84216C)

**RECTANGULAR,  
2" X 2", SNAP-FIT**

Part Number	Lens Color	Compatible Parts
99160R	Red	M/C Lamps (26311R, 26313R)  Signal Stat (1113, 1114)
99160Y	Yellow	M/C Lamps (26311Y, 26313Y)  Signal Stat (1113, 1114)

**RECTANGULAR,  
2" X 3", 2-SCREW**

Part Number	Lens Color	Compatible Parts
8947	Red	M/C Lamps (1570)  Trailer Lamps (533DK, 534D, 535D)
8947A	Yellow	M/C Lamps (1570A)  Trailer Lamps (533DK, 534D, 535D)
9088A	Yellow	Trailer Kit (5050DK, 5051DK, 5052AD)
9090	Red	Trailer Kit (5050DK, 5051DK, 5052AD)
9371	Red	1571
9371A	Yellow	1571AD
9371W	Clear	1571

**RECTANGULAR,  
2" X 4", SNAP-FIT**

Part Number	Lens Color	Compatible Parts
8939A	Yellow	Pedestal Lamps (4742, 4754)
9007	Red	Headlamps-Fog & Driving (27004)  Lighting Kit (80893)  M/C Lamps (1201, 1203, 1204, 1211, 1213, 1215, 1216, 1253)
9057	Red	M/C Lamps (1221,1222)
9057A	Yellow	M/C Lamps (1221,1222A)

**RECTANGULAR,  
2" X 4", 1-SCREW**

Part Number	Lens Color	Compatible Parts
99170R	Red	Bus Lamps (26353R, 1151)
99170Y	Yellow	Bus Lamps (26353Y, 1151)

**RECTANGULAR,  
2" X 4", 2-SCREW**

Part Number	Lens Color	Compatible Parts
99238R	Red	M/C Lamps (2660, 2661)
99238Y	Yellow	M/C Lamps (2660A, 2661A)
9080A	Yellow	Pedestal Lamps (4810, 4842, 81331, 4800, 4801, 4805AAY115, 4805AAY118, 4805AY116, 4805AY117)

**RECTANGULAR,  
2" X 5", 2-SCREW**

Part Number	Lens Color	Compatible Parts
99012R	Red	M/C Lamps (18300R)
99012Y	Yellow	M/C Lamps (18300Y)
8930	Red	M/C Lamps (26315R, 1117)
8930A	Yellow	M/C Lamps (26315Y, 1117)
9771A	Yellow	Lamps (9770A)

**RECTANGULAR,  
2" X 6", 2-SCREW**

Part Number	Lens Color	Compatible Parts
8900	Red	1265, 1265A
8900A	Yellow	1265, 1265A

**RECTANGULAR,  
2"X 23", SNAP-FIT**

Part Number	Lens Color	Compatible Parts
99236C	Clear	Dome & Utility (84211C)

**RECTANGULAR,  
2"X 47", SNAP-FIT**

Part Number	Lens Color	Compatible Parts
99235C	Clear	Dome & Utility (84201C)

**RECTANGULAR,  
3"X 5", SNAP-FIT**

Part Number	Lens Color	Compatible Parts
99086R	Red	Do-Ray (8845R/Y-1), Pedestal Lamps (70352, 70353, 70356 & 70357), Signal-Stat (4758, 4759, 8864/A)
99086Y	Yellow	Do-Ray (8845R/Y-1), Pedestal Lamps (70352, 70353, 70356 & 70357), Signal-Stat (4758, 4759, 8864/A)

**RECTANGULAR,  
3"X 5", 2-SCREW**

Part Number	Lens Color	Compatible Parts
9372	Red	Signal Lighting Lamps (548, 549)
9372A	Yellow	Signal Lighting Lamps (548, 549A)
9373W	Clear	Dome & Utility (549SWD)
80578	Clear	Headlamps-Fog & Driving (80525, 80526)
80579	Clear	Headlamps-Fog & Driving (80525, 80526)
80580	Yellow	Headlamps-Fog & Driving (80527)
99087R	Red	80308R, 81304R/Y, Do-Ray Lamps
99087Y	Yellow	80308R, 81304R/Y, Do-Ray Lamps

**RECTANGULAR,  
3"X 7", 2-SCREW**

Part Number	Lens Color	Compatible Parts
99172	Clear	Bus Lamps (81350 Dome)
80569	Yellow	Headlamps-Fog & Driving (80519)
80567	Clear	Headlamps-Fog & Driving (80513, 80514)
80568	Clear	Headlamps-Fog & Driving (80513, 80514)
97724	Clear	West Coast Mirrors 7 in x16 in Box Style

**RECTANGULAR,  
3"X 8", 4-SCREW**

Part Number	Lens Color	Compatible Parts
9676	Red	Lamps (528, 529), Trailer Kit (530DK)

**RECTANGULAR,  
4"X 5", SNAP-FIT**

Part Number	Lens Color	Compatible Parts
99126R	Red-Clear	Lamps (80317R, 80318R)
99127R	Red	Lamps (80317R, 80318R)

**RECTANGULAR,  
4"X 5", 3-SCREW**

Part Number	Lens Color	Compatible Parts
8923	Red	Signal Lighting Lamps (4701, 4702, 4703, 4704)
8923A	Yellow	Signal Lighting Lamps (4701, 4702, 4703, 4704)

**RECTANGULAR,  
4"X 10.5", 1-SCREW**

Part Number	Lens Color	Compatible Parts
8925A	Yellow	Chrome Cab Marker (1350A)

**RECTANGULAR,  
4"X 16", 8-SCREW**

Part Number	Lens Color	Compatible Parts
99245C	Clear	Dome & Utility (80251C)

**RECTANGULAR,  
6"X 7", SNAP-FIT**

Part Number	Lens Color	Compatible Parts
9072	Red	Lamps (5010 Series)

**RECTANGULAR,  
6"X 7", 4-SCREW**

Part Number	Lens Color	Compatible Parts
9049	Red	4010 Series, Box Lamps (4025, 4026, 4027, 4028) Trailer Kits (5315Y101, 5316Y101)
9071	Red	Box Lamps (4015, 4016, 4017, 4018, 4023, 4024)

**RECTANGULAR,  
7"X 13", SNAP-FIT**

Part Number	Lens Color	Compatible Parts
99152	Yellow	Signal Lighting Lamps (40802, 40803, 40804, 40805)

**RECTANGULAR,  
7"X 16", 6-SCREW**

Part Number	Lens Color	Compatible Parts
99151Y	Yellow	Light Bars (92520Y, 92521Y, 92522Y, 92523Y, 92524Y, 92525Y)

**RECTANGULAR,  
7"X 17", 4-SCREW**

Part Number	Lens Color	Compatible Parts
99226Y	Yellow	Light Bars (92684, 92685)
99227Y	Yellow	Light Bars (92684, 92685)

**RECTANGULAR,  
10"X 12", SNAP-FIT**

Part Number	Lens Color	Compatible Parts
99204Y	Yellow	Light Bars (92674Y, 92675Y, 92676Y, 92677Y)

**RECTANGULAR,  
10"X 15", 4-SCREW**

Part Number	Lens Color	Compatible Parts
99193Y	Yellow	Light Bars (92674Y, 92675Y, 92676Y, 92677Y)

**RECTANGULAR,  
12"X 18", 4-SCREW**

Part Number	Lens Color	Compatible Parts
99203Y	Yellow	Light Bars (92674Y, 92675Y, 92677Y)
99205Y	Yellow	Light Bars (92674Y, 92675Y, 92677Y)

**RECTANGULAR,  
15"X 18", 4-SCREW**

Part Number	Lens Color	Compatible Parts
99192Y	Yellow	Light Bars (92668Y, 92669Y, 92670Y, 92671Y)
99205Y	Yellow	Light Bars (92674Y, 92675Y, 92677Y)

### SQUARE, 4" X 4", SNAP-FIT

Part Number	Lens Color	Compatible Parts
8006	Red	Direction Indicator Lamps, STT/B/U Lamps (8000, 8001, 8002)
8007	Clear	Direction Indicator Lamps, STT/B/U Lamps (8000, 8001, 8002)
8008	Yellow	Direction Indicator Lamps, STT/B/U Lamps (8000, 8001, 8002)

### SQUARE, 4" X 4", 4-SCREW

Part Number	Lens Color	Compatible Parts
8960	Red	Pedestal Lamps (940, 941, 950, 955, 956, 957)
8960A	Yellow	Pedestal Lamps (940, 941, 950, 955, 956AA, 957AA)

### SQUARE, 4.5" X 4.5", 4-SCREW

Part Number	Lens Color	Compatible Parts
8948	Red	Trailer Lamps (533DK, 534D, 535D)
9083	Red	Pedestal Lamps (4805AY116, 4805AY117)
9083A	Yellow	Pedestal Lamps (4872AA, 4805AY116, 4805AY117)
9063	Red	Pedestal Lamps (4854, 4855, 4810, 4800, 4801)
9063A	Yellow	Pedestal Lamps (4874AY101, 4810, 4800, 4801)
9074A	Yellow	4852, 4853, 4868, 4869
9078A	Yellow	Pedestal Lamps (4854, 4855)
9089	Clear	Trailer Kit (5050DK, 5051DK, 5052AD)
9079	Red	Pedestal Lamps (4842)
9079A	Yellow	Pedestal Lamps (4842, 81331, 4805AAY115, 4805AAY118)

### SQUARE, 5" X 5", SNAP-FIT

Part Number	Lens Color	Compatible Parts
8938	Red	Pedestal Lamps (4742, 4754)
8938A	Yellow	Pedestal Lamps (4742, 4754)
9084A	Yellow	Pedestal Lamps (5800AA, 5800AAK)

### SQUARE, 7" X 7", 4-SCREW

Part Number	Lens Color	Compatible Parts
9382	Red	Bus Lamps (6500, 6502)
9382A	Yellow	Bus Lamps (6500A)
9382W	Clear	Bus Lamps (6500, 6502)
9384	Red	Bus Lamps (6501)
9384A	Yellow	Bus Lamps (6501A)

### TRIANGULAR 2" X 7", SNAP-FIT

Part Number	Lens Color	Compatible Parts
7021	Yellow	25761Y

### TRIANGULAR 2.75" X 3.5", SNAP-FIT

Part Number	Lens Color	Compatible Parts
99165Y	Yellow	Cab Marker (25762Y)
99063R	Red	26771R/Y, Do-Ray Lamps
99063Y	Yellow	26771R/Y, Do-Ray Lamps

### TRIANGULAR 3" X 4", 1-SCREW

Part Number	Lens Color	Compatible Parts
8861	Red	Bus Lamps (1150)
8861A	Yellow	Bus Lamps (1150A)

### BEEHIVE, 2.5", SNAP-FIT

Part Number	Lens Color	Compatible Parts
99039R	Red	26322, 26740, 26741, Do-Ray Lamps, Signal-Stat (9004 Series)
99039Y	Yellow	26322, 26740, 26741, Do-Ray Lamps, Signal-Stat (9004 Series)
9004	Red	Beehive Lamps, M/C Lamps (1001, 26740R, 26741R)
9004A	Yellow	Beehive Lamps, M/C Lamps (1001AD)
9004G	Green	Beehive Lamps
9004W	Clear	Beehive Lamps



# Looking for even more product information?

Visit [truck-lite.com](http://truck-lite.com)



**Powerful Search  
Function**



**360° Product  
Images**



**Easy-To-Find  
Replacement  
Parts**

# HALOGEN



	Part Number	Lamp Style	Bulb Wattage	Volts	Compatible Parts
	80560	H3	100	12	Driving Lamp (613W), Fog Lamp (612W), Headlamp, Off-Road Lights, Work Lamp (610W)
	80561	H3	70	24	Auxiliary & Emergency Lamps, Flood Lamp (629WD), Spot Lamp (628WD), Work Lamp (637W)
	80562	H3	45	36	Driving Lamp (613W), Fog Lamp (612W), Material Handling Industry, Work Lamp (610W)
	80563	H1	55	12	Beacon (6822A, 6823A, 92602R, 92602B), Light Bar (92674Y)
	80564	SC Bayonet	50	12	335 Series Lamp
	80571	H3	55	12	Driving Lamps (613W, 80520, 80513, 80525), Flood Lamps (80491, 80494, 629WD, 80493), Fog Lamps (612W, 80521, 80522, 80514, 80519, 80526, 80527), Off-Road Lights, Spot Lamps (80492, 628WD), Work Lamps (80498, 627WD, 637W, 610W)
	92722		50	12	Light Bar (92669Y, 92668Y)

## HALOGEN (continued)





HALOGEN

	Part Number	Lamp Style	Bulb Wattage	Volts	Compatible Parts
	92810		50	12	Halogen Rotator Power Bar
	80596	9003	65	12	Dual Headlamp Systems, Headlamp (27012, 27009)
	80597	9004	60	12	Dual Headlamp Systems
	80598	9005	65	12	Dual Headlamp Systems
	80599	9006	55	12	Dual Headlamp Systems
	92883		23	12	92620Y

HALOGEN

# HALOGEN





	Part Number	Bulb Wattage	Volts	Compatible Parts
	60-50121	50	12	Whelen 97 Series Lamps, Genuine Whelen replacement H50TL12, Twist-lock 50 watt halogen bulb for Whelen 97 series lamps
	60-50123	50	12	4000 Series Light Bar, Whelen 64 & 73 Series Lamps, Genuine Whelen replacement H50SN12, Snap-in 50 watt halogen bulb for Whelen 64 and 73 series lamps and 4000 series light bar
	60-50124	50	12	Warning Lights, Genuine Whelen replacement H50ASN1, 50 watt snap-in halogen

INCANDESCENT





# INCANDESCENT



	Part Number	Lamp Style	Bulb Wattage	Volts	Compatible Parts
	80604	T4-5/8	20	12	Dome & Utility (20302, 20308), Turn Signal Lamp (20309Y, 20310Y)
	80700				F15T8 Tubes





## INCANDESCENT



	Part Number	Bulb Wattage	Volts	Compatible Parts
	88-2126	30	12	6600, 6601, 6610 & 6611 Strobe Lamps, Whelen FT-10A Lamp
	8810	30	12	6800, 6801, 6810 & 6811 Strobe Lamps, Whelen FT-10A Lamp
	8820	50	12	Warning Lights, Genuine Whelen replacement H50ASN1, 50 watt snap-in halogen
	92711			Gas Discharge Mini Strobes, LED & Gas Discharge Strobes
	92715			

# STROBE TUBE



	Part Number	Bulb Wattage	Volts	Compatible Parts
	88-43210	25	12	300, 301, 302, 309 & 337 Series Strobe Lamps
	8830			Whelen Fire/Ambulance Strobe Lamps
	8850	50	12	Whelen 9000 Series Light bars
	8812			Strobe Lamps

## STROBE ROTATOR



Part Number	Lighting Technology	Lamp Connection	Plug Side 2	Housing Material
92720	Halogen	Hardwired	Stripped End	Plastic

STROBE ROTATOR

## STROBE ROTATOR



Part Number	Lamp Connection	Housing Material
92721	Two Blade	Steel

STROBE ROTATOR

## STROBE ROTATOR



Part Number	Lighting Technology	Lamp Connection	Plug Side 2	Housing Material
92800	Halogen	Hardwired	Blade Terminal Stripped End	Plastic

STROBE ROTATOR

MOUNTING MAGNET

## STROBE MOUNTING MAGNET, STEEL



- Magnets are coated to reduce the likelihood of scratching the paint of a towed vehicle onto which these lamps are mounted



Part Number	Housing Material	Mount Type
87845	Steel	110lb Pull Force

MOUNTING MAGNET

## STROBE MOUNTING MAGNET, STEEL, KIT



- Mounting hardware and instructions
- Single magnet: 316
- Four 3" diameter magnets with hardware for #9674
- 90lb pull force for #9674
- For use with 389/399 series warning lamps and 6850A strobe bar for #9674
- Kit contains: magnet, hardware, foam pad, 8' cigarette plug for use with #9702
- 90lb pull force with #9702
- For use with 6600, 6601, 6610, 6611, 6800, 6801, 6810, and 6811 strobe beacons



Part Number	Housing Material	Mount Type
9702	Steel	90lb Pull Force

MOUNTING MAGNET

## STROBE MOUNTING MAGNET, STEEL, KIT



- Mounting hardware and instructions
- Single magnet: 316
- Four 3" diameter magnets with hardware for #9674
- 90lb pull force for #9674
- For use with 389/399 series warning lamps and 6850A strobe bar for #9674
- Kit contains: magnet, hardware, foam pad, 8' cigarette plug for use with #9702
- 90lb pull force with #9702
- For use with 6600, 6601, 6610, 6611, 6800, 6801, 6810, and 6811 strobe beacons



Part Number	Housing Material	Mount Type
9674	Steel	90lb Pull Force

MOUNTING MAGNET

## STROBE MOUNTING MAGNET, RUBBER



- Magnetic Mount Base



Part Number	Housing Material	Mount Type
92547	Steel	120lb Pull Force



## HARDWIRED, .180 BULLET TERMINAL, FEMALE .180 BULLET



Part Number	Lamp Connection	Plug Side 1	Plug Side 2	Housing Material	Housing Color
96820	Hardwired	Hardwired	.180 Bullet   Female .180 Bullet	Black	Aluminum

STROBE POWER SUPPLY

## MINIBARS, HARDWIRED, STRIPPED END, 12-24V



Part Number	Lamp Connection	Plug Side 1	Plug Side 2	Housing Material	Housing Color
92716	Hardwired	Hardwired	Stripped End	Silver	Aluminum

STROBE POWER SUPPLY

## STROBE POWER SUPPLY, HIDE-A-WAY SYSTEM 4 LIGHTS KIT, 3 PIN CONNECTOR, STRIPPED END, 12-24V



- Flash patterns comply with SAE J1318 requirements for on-time/off-time
- 6602PS/6606PS supply remote strobe heads with 80 quad FPM
- 6660PS supply remote strobe heads with 70 quad or double FPM
- High/low power control
- Input current regulation
- Input reverse polarity protection
- 6602PS draws 3 amp, 12 VDC - 1.5 amp, 24 VDC
- 6606PS draws 3.8 amp, 12 VDC - 1.9 amp, 24 VDC
- 6660PS draws 6 amp, 12 VDC - 3 amp, 24 VDC
- Recommended using only with shielded cable to avoid RFI problems

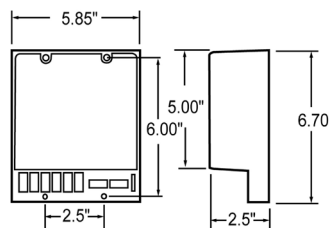

Part Number	Lamp Connection	Plug Side 1	Plug Side 2	Housing Material	Housing Color
6660PS	3 Pin Connector	3 Pin Connector	Stripped End	Black	Aluminum

STROBE POWER SUPPLY

## ELECTRO-MECHANICAL, 2 BLADE TERMINAL

ELECTRO-MECHANICAL

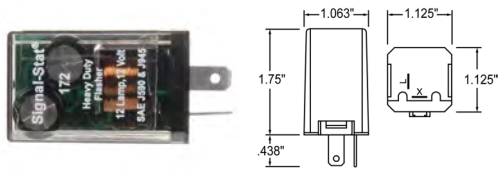

**PART# 172, 182, 282**

- Certification for 16 bulb capacity for hazard warning
- Flashes up to eight 32 CP bulbs per side, plus pilot bulb
- 35 amp capacity at 12VDC
- Low profile, only 1-1/4" height above terminals



**PART# 262**

- Flashes at a rate of 60 to 120 FPM, with first flash less than 1.5 seconds after startup
- Bi-polar flasher functions continuously at 13V for 36 hours with 10-32 CP lamps, 20 AMP max
- Uses standard 1/4" male blade terminals
- Features double coil relay with electronic components
- Replaces Truck-Lite 97202/03/04 series

Part Number	Strobe Frequency Min_FPM	Strobe Frequency Max_FPM	Plug Side Two	Volts	Standards Met
172	70	120	Lamp Connection	12	J590, J945
182	70	120	Lamp Connection	12	J590, J945, J1054
262	60	120	Lamp Connection	12	J590, J945
282	70	120	Lamp Connection	12	J590, J945, J1054

## ELECTRO-MECHANICAL, 3 BLADE TERMINAL

ELECTRO-MECHANICAL

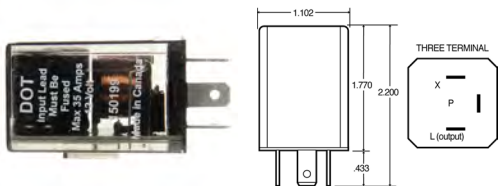

- Flashes at a rate of 70 to 120 FPM, with first flash less than 1.3 seconds after startup
- Functions at 13v for 36 continuous hours with 16-32 cp lamps at 35 amp max (#182 and 183), 20-32 cp lamps at 45 amp max (#282 and 283), 10-32 cp lamps alternating at 25 amp max per side (#286)
- Five available versions include 16-lamp with 2- or 3- terminal, 20-lamp with 2- or 3- terminal and alternating 10-lamp with 3- terminal
- Features ISO relay with electronic control circuits
- Replaces Truck-Lite 97205 & 97209



Part Number	Strobe Frequency Min_FPM	Strobe Frequency Max_FPM	Volts	Standards Met
173	70	120	12	J590, J945, J1054
183	70	120	12	J590, J945, J1054
283	70	120	12	J590, J945, J1054
286	70	120	12	J590, J945, J1054

## ELECTRO-MECHANICAL, 3 BLADE TERMINAL



- 2-4 lamp load capability with outage indication
- 8 for hazard warning
- Third prong used for ground function

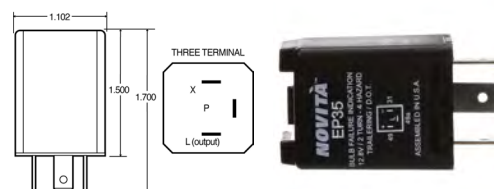

Part Number	Strobe Frequency Min_FPM	Strobe Frequency Max_FPM	Volts	Standards Met
264	70	100	12	J590 J945
266	70	100	12	J590 J945

ELECTRO-MECHANICAL

## ELECTRO-MECHANICAL, 3 BLADE TERMINAL



- 2-4 lamp load capability with outage indication
- 8 for hazard warning
- Third prong used for ground function



Part Number	Strobe Frequency Min_FPM	Strobe Frequency Max_FPM	Volts	Standards Met
263	60	120	12	J590 J945
2634	60	120	24	J590 J945

ELECTRO-MECHANICAL

## ELECTRO-MECHANICAL, 2 BLADE TERMINAL, 2 SCREW



### PART# 242

- Certification for 16 bulb capacity for hazard warning
- Flashes up to eight 32 CP bulbs per side, plus pilot bulb
- 35 amp capacity at 12VDC
- Low profile, only 1-1/4" height above terminals

### PART# 243

- Flashes up to five 32 CP bulbs per side, plus pilot bulb
- Flashes ten 32 CP bulbs for hazard warning
- 25 amp capacity @ 12VDC
- Low profile, only 1-1/4" height above terminals

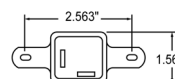
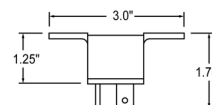

Part Number	Strobe Frequency Min_FPM	Strobe Frequency Max_FPM	Volts	Standards Met
242	60	120	12	J590, J945t
243	60	120	12	J590, J945t

ELECTRO-MECHANICAL

## ELECTRO-MECHANICAL, 2 SCREW, HARDWIRED

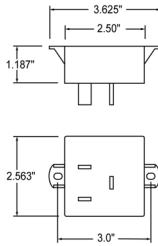

- Mack 47M019301P2 (SS# 250)
- Conforms to DOT and SAE specifications
- Test proven to exceed 1.5 million cycles of continuous operation at maximum capacity without failure
- Certified for ten bulb load hazard warning, five bulb load turn signal, plus pilot
- Polycarbonate housing and brass terminals for superior corrosion resistance and better conductivity
- For school buses or emergency vehicles
- Flashes two 75 watt sealed beams per circuit



Part Number	Strobe Frequency Min_FPM	Strobe Frequency Max_FPM	Plug Side Two	Volts	Standards Met
250	60	90	2 Spade Terminal, Ring Terminal	12	J590,J945,J1054
256	60	90	3 Spade Terminal Ring, Terminal	12	J590,J945,J1054
2584	60	120	Spade Terminal Ring, Terminal	24	J590,J945,J1054

## ELECTRO-MECHANICAL, HARDWIRED

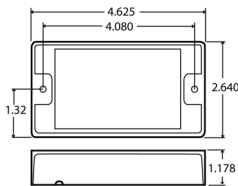

- Hardwired allowing alternating flashing of up to 20 LED lamps (10 lamps per side)
- Features color coded wires, epoxy-sealed circuitry and installation instructions
- Operates on 12V or 24V systems
- Maximum 5 amp load
- Flashes 3 times per 1/2 second



Part Number	Strobe Frequency Max_FPM	Plug Side Two	Volts
97235	360	Stripped End	12   24
97251	480	Fit 'N Forget S.S./ Straight Female PL-2	12   24

## ELECTRO-MECHANICAL, 2 SCREW, HARDWIRED

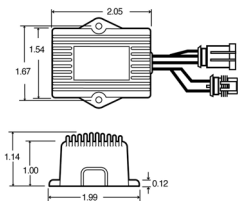

- Designed for use in automotive and heavy duty applications
- Creates a strobe flash on an LED lamp
- Hardwired design eliminates pin corrosion
- Features coded wires and epoxy sealed circuitry for durability and long term use
- Designed to operate in temperature range -40°C to 85°C
- Full operation voltage range 12V to 24V
- Maximum current 7 amps
- Flashes 3 times per 1/2 second
- Uses 2 modules as alternating LED strobe without cutting or splicing



truck-lite.com | (800) 888-7095

Part Number	Strobe Frequency Max_FPM	Plug Side Two	Volts
97253	360	Fit 'N Forget S.S./ 3 Position Connector 282105	12   24

ELECTRO-MECHANICAL

ELECTRO-MECHANICAL

ELECTRO-MECHANICAL

## SOLID-STATE, HARDWIRED



- This solid-state flasher operates from 1 milliamp up to 6 amps - allowing the use of two incandescent signal lamps with LED S/T/T lamps
- Solid-state timing circuitry provides reliability
- Flashes at a rate of 90 FPM
- Size: 1-1/8" W x 1-5/8" H

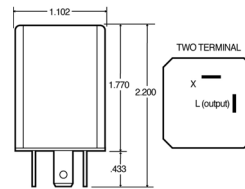

Part Number	Strobe Frequency Max_FPM	Plug Side Two	Volts	Standards Met
285	90	Spade Terminal Fork Terminal	12	J590, J945

SOLID-STATE

## SOLID-STATE, 2 SCREW, HARDWIRED



- For interior lighting in trailers, package car and body vans
- Hardwired design and solid state operation
- Features ABS housing, coded wires, epoxy-sealed circuitry and installation instructions
- Designed to operate in temperature range 40°C to 85°
- Full operation voltage range 12V to 24V
- Solid-state operation
- Timing module can be configured for 20, 30 or 60 minute intervals, depending upon wiring
- Maximum current 7 amps
- Includes 3 minute time remaining feature

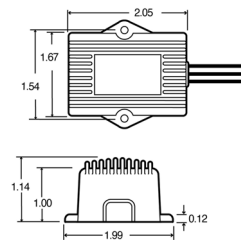

Part Number	Plug Side Two	Volts
97254	Stripped End	12   24

SOLID-STATE

## HEAVY-DUTY SOLID-STATE, 2 SCREW, HARDWIRED



- Rated for 42 amp load
- For use on double and triple trailer combination, sanitation vehicles, delivery and courier vehicles, heavy haulers and emergency vehicles
- Operates LED lamps as well as incandescent lamps
- Flasher unit includes 11" of wiring for remote mounting

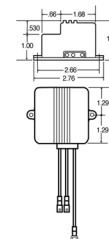

Part Number	Strobe Frequency Min_FPM	Strobe Frequency Max_FPM	Plug Side Two	Volts	Standards Met
270	80	100	2 Spade Terminal Fork Terminal	12	J590, J945, J1054
270Y1014	80	100	Spade Terminal Fork Terminal	24	J590, J945, J1054
275	80	100	3 Spade Terminal Fork Terminal	12	J590, J945, J105
276	81	99	3 Spade Terminal Fork Terminal	12	J590, J945, J1054

SOLID-STATE

SOLID-STATE

## HEAVY-DUTY SOLID-STATE, 2 SCREW, HARDWIRED

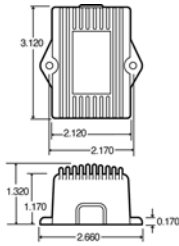

- ULTRA FLASH II
- Solid-state electronics are sealed in polyurethane for moisture and corrosion protection
- Surface mounts with two 1/2"-6 pan head screws at 2.12" centers or with two 4" cable ties (both included)
- Protects against short circuit overloads with a self-resetting feature
- Works with LED or incandescent lamps on 12V or 24V electrical systems
- 97231, 97232 and 97233 rated for loads below 25 amps or 12-32 cp bulbs
- 97201 rated for loads below 17 amps per channel or 8-32/3 cp bulbs
- Optional remote wiring requires 12" jumper wire, 94954
- 97231, 97232 and 97333 feature folding bi-polar plug with 11" leads for reverse polarity operation
- 97201 features three 1/4" tabs and one 1/4" ring with heat shrink tubing and 12" leads
- 97201 used for wig/wag system
- For interior/cab use only
- Do not expose to moisture or liquid



Part Number	Strobe Frequency Max_FPM	Plug Side Two	Volts	Standards Met
97201	90	Spade Terminal Ring Terminal	12   24	J590, J1054
97231	90	Bi-Polar Plug Ring Terminal	12   24	J590, J1054
97232	90	Bi-Polar Plug Ring Terminal	12   24	J590, J1054
97233	90	Bi-Polar Plug Ring Terminal	12   24	J590, J1054

SOLID-STATE

## HEAVY-DUTY SOLID-STATE, 3 SCREW, HARDWIRED

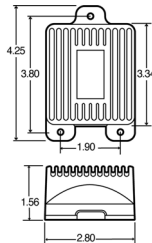

- ULTRA FLASH II High Current
- Solid-state electronics are totally encapsulated in polyurethane for moisture and corrosion protection
- Designed to protect against short circuit overloads with a self-resetting feature
- 97270 and 97271 rated for loads below 40 amps at 12.8V (20,32 cp) or below 20 amps at 25.6V
- 97272 rated for loads below 25 amps at 12.8V per channel or below 12.5 amps at 25.6V per channel
- Designed to work with 12V or 24V electrical systems and operated from 9V to 32V
- 97270 and 97271 feature 12" leads with two 1/4" spade terminals and one 1/4" ring with heat shrink tubing
- 97272 features 12" leads with three 1/4" spade terminals and one 1/4" ring with heat sink tubing
- Used for both LED or incandescent lamps
- Do not expose to moisture or liquid



Part Number	Audible	Strobe Frequency Max_FPM	Plug Side Two	Voltage	Standards Met
97270	Non-Audible	90	Spade Terminal/ Ring Terminal	12   24	J590, J945, J1054
97271	Audible	90	Spade Terminal/ Ring Terminal	12   24	J590, J945, J1054
97272	3-Spade Non-Audible	90	Spade Terminal/ Ring Terminal	12   24	J590, J945, J1054

## HEAVY-DUTY SOLID-STATE, 5 BLADE TERMINAL

SOLID-STATE



- Maintains normal flash rate when used to flash LED lamps
- Simple installation using existing plug footprint
- Heavy-duty solid state circuitry
- Long lasting service life means lower maintenance costs
- Designed for use with low current LED lamps
- Non audible
- Compatible with trailer tow packages
- 5 pin configuration for turn and hazard flashing
- 5 amp maximum per output
- Conforms to DOT FMVSS 108, SAE J590 and J945

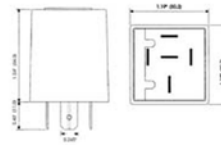

Part Number	Voltage_VLT	Standards Met
97283	12	J590, J945

## THERMAL, 2 BLADE TERMINALS

THERMAL



- Heavy duty, longer life, variable load
- Flashes up to three 32 cp bulbs per side, plus pilot bulb (550 only)
- Flashes up to six 32 cp bulbs for hazard warning
- Aluminum housing

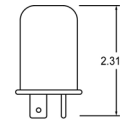

Part Number	Strobe Frequency Min_FPM	Strobe Frequency Max_FPM	Volts	Standards Met
536	60	120	12	J590b J945
550	60	120	12	J590b J945
552	60	120	12	J2068

## THERMAL, HARDWIRED

THERMAL



- 6 amp capacity @ 12 VDC
- Includes spade terminals for ease of installation
- Brass housing for corrosion resistance
- Mounts via single screw
- 4" lead wires

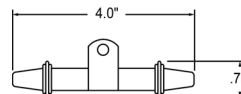

Part Number	Strobe Frequency Min_FPM	Strobe Frequency Max_FPM	Plug Side Two	Volts	Standards Met
245	60	120	Spade Terminal	12	J590, J945

UNIVERSAL

## UNIVERSAL FLASHER CONNECTOR, 3 FEMALE BLADE TERMINALS



- Exclusive design accommodates 2 or 3 prong flashers
- Includes 15 amp blade type fuse
- Ring terminal on lead wire
- For use with 12V or 24V applications



Part Number	Plug Side Two	Volts
9187	Stripped End Ring Terminal	12   24

FLASHER CONNECTOR

## FLASHER CONNECTOR, 3 FEMALE BLADE TERMINALS



- Includes 15 amp blade type fuse
- Ring terminal on lead wire
- 7" color coded wire leads
- Insulated 16 gauge wire leads
- For use with 12V or 24V applications



Part Number	Plug Side Two	Volts
9186	Stripped End/ Ring Terminal	12   24



## DRL SYSTEM, HARDWIRED



- Features state-of-the-art electronics sealed in epoxy for protection
- Module installs easily using a three-wire design
- Relay-controlled output activates low beam headlamps at full intensity whenever the ignition is turned on
- Meets or exceeds CSA guidelines
- Do not expose to moisture, excessive engine compartment temperature or circuit overload
- Work with most Ford, GM and Dodge vehicles
- For use with positive switching headlamps only
- Not for use with positive ground vehicles

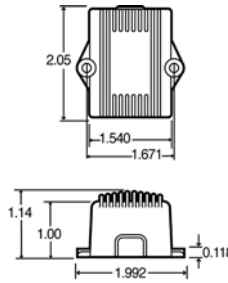

Part Number	Amps	Volts	Housing Material
97300	15	12	PC

DRL SYSTEM

## DRL SYSTEM, HARDWIRED, BLUNT CUT



- Operates low beam headlamps at reduced intensity (75%) for prolonged lamp life
- Unit features 15-second “time-in” delay and tail/marker lamp activation
- Park brake disable feature locks out system when parking brake is engaged
- Electronics are sealed in epoxy for protection and are short-circuit protected
- Exceeds GM and Ford’s electrical, environmental, RFI and EMI specifications
- Meets or exceeds SAE, NHTSA and CSA guidelines

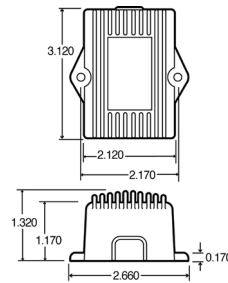

Part Number	Volts	Housing Material
97302	12	Steel

DRL SYSTEM

5 BLADE TERMINAL

### 5 BLADE TERMINAL



- These relays replace both Hella and Bosch units

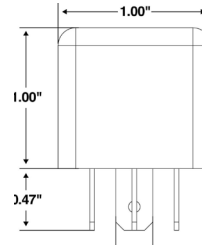

Part Number	Amps	Volts	Housing Material
190	40	12	PC

5 BLADE TERMINAL

### 5 BLADE TERMINAL



- These relays replace both Hella and Bosch units

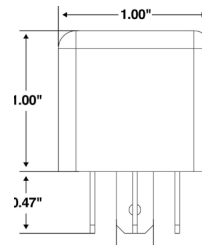

Part Number	Amps	Volts	Housing Material
191	40	12	PC

5 BLADE TERMINAL

### 5 BLADE TERMINAL, TAB



- These relays replace both Hella and Bosch units

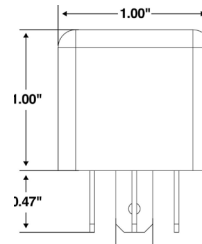

Part Number	Amps	Volts	Housing Material
192	40	12	PC

5 BLADE TERMINAL

### 5 BLADE TERMINAL, DISPLAY PACKAGING



- These relays replace both Hella and Bosch units

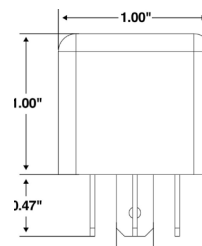

Part Number	Amps	Volts	Housing Material
192D	40	12	PC

## 5 BLADE TERMINAL



- These relays replace both Bosch units

Part Number	Amps	Volts	Housing Material
1924	22	24	PC

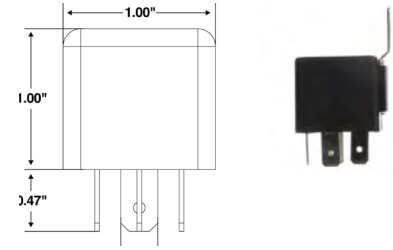

5 BLADE TERMINAL

## 4 BLADE TERMINAL



- These relays replace both Hella and Bosch units

Part Number	Amps	Volts	Housing Material
194	40	12	PC

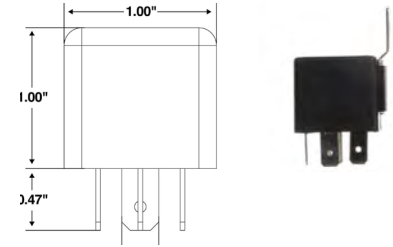

4 BLADE TERMINAL

## 4 BLADE TERMINAL



- These relays replace both Hella and Bosch units

Part Number	Amps	Volts	Housing Material
195	70	12	PC

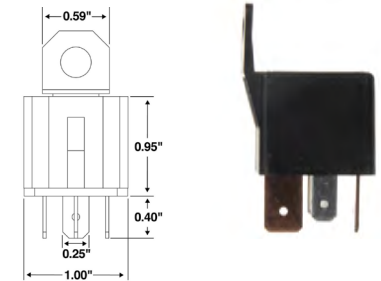

4 BLADE TERMINAL

## 4 BLADE TERMINAL, KIT



- Recommended for use where heavy amp draw is required
- Includes 20 feet of 14 gauge wire, connectors, mounting hardware and wiring diagram

Part Number	Amps	Volts	Housing Material
125	70	12	PC



4 BLADE TERMINAL

# LIGHT MOUNTING

## LIGHT HOUSING

Pages 340-341

## LIGHT MOUNTING BRACKETS & FLANGES

Pages 342-369

SERIES	PAGES
10® Series	342-345
12® Series	345
15® Series	346-348
19® Series	349-351
26 Series	351
30® Series	352-354
33® Series	355-356
35® Series	356
36 Series	357
40® Series	357-359
45® Series	359
Super 21®	360
Bracket Mount	360-367
Flange Mount	368-369
Covers	369

## LIGHT MOUNTING GASKETS

Pages 370-374

## LIGHT MOUNTING HARDWARE

Pages 375-378

## GROMMET MOUNTS

Pages 379-385

SERIES	PAGES
10® Series	379-380
14 Series	380
15® Series	381
30® Series	381-382
33® Series	382-383
40® Series	383
44® Series	384
45® Series	384
60® Series	384-385

### 1 STUD MOUNT, 5" ROUND



Part Number	Compatible Parts	Material
620H	80202, 80203, 80200	Rubber



### 1 STUD MOUNT, 5" ROUND



Part Number	Compatible Parts	Material
630H	80202, 80203, 80200	Rubber



### 1 STUD MOUNT, 5" ROUND

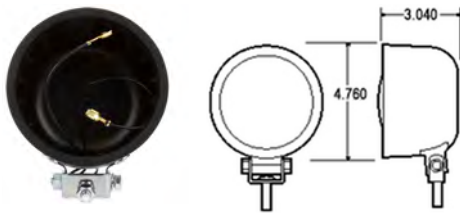

Part Number	Compatible Parts	Material
97980	80202, 80203, 80200	Rubber



### 1 STUD MOUNT, 5" ROUND

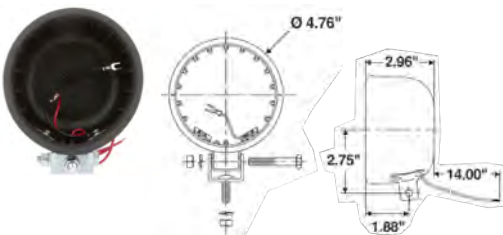

Part Number	Compatible Parts	Material
80497	80202, 80203, 80200	Rubber



### 1 STUD MOUNT, RECTANGULAR

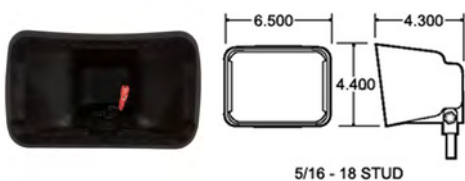

Part Number	Compatible Parts	Material
97989	80205, 80207, 80209, 80204, 80206	Rubber



LIGHT HOUSING

LIGHT HOUSING

LIGHT HOUSING

LIGHT HOUSING

LIGHT HOUSING

## LENS HOOD, GRAY



Part Number	Compatible Parts	Material
8951W	425	Gray ABS

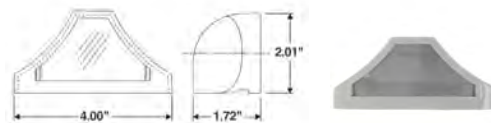

LENS HOOD

## LENS HOOD, CHROME



Part Number	Compatible Parts	Material
8952W	425	Chrome ABS

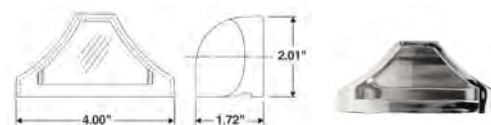

LENS HOOD

## BRACKET MOUNT 2 SCREW, WHITE



Part Number	Compatible Parts	Material
60789	99011Y, 99011R	White PC



BRACKET MOUNT

10 SERIES

## 10<sup>®</sup> SERIES, BRACKET MOUNT, 2 SCREW

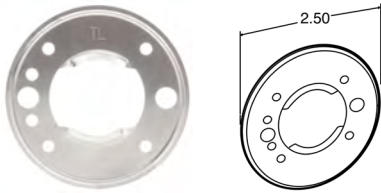

- Rust resistant, stainless steel mount
- Quick cam-on, cam-off lamp installation
- Suitable for PC requirements on a 45-degree angle using all 2-1/2" diameter lamps
- Mounts with screws to surface
- Model 10 kits available
- Not recommended for use with Signal-Stat LED products
- Replaces Signal-Stat 9394



Part Number	Mount Material	Mount Color
10720	Stainless Steel	Silver

10 SERIES

## 10<sup>®</sup> SERIES, BRACKET MOUNT, 2 SCREW

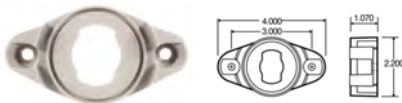

- High-impact plastic mount
- Branch deflector cams-on 2 and 2 1/2" lamps
- Requires 94924 side entry plug
- Suitable for PC requirements on a 45-degree angle when using LED or incandescent PC rated/combination lamps
- Not recommended for use with Signal-Stat LED products
- Replaces Signal-Stat 9390



Part Number	Mount Material	Mount Color	Back
10721	PC	Clear	
10724	PC	Gray	
10727	PC	Clear	Rib Back
10728	PC	Gray	Rib Back

10 SERIES

## 10<sup>®</sup> SERIES, BRACKET MOUNT, 2 SCREW

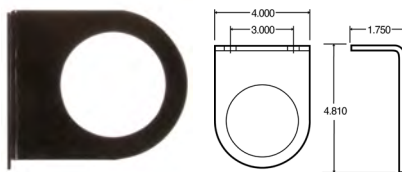

- Black epoxy painted heavy gauge steel
- 10729 is designed for mounting grommets: #10700, #10701, #10713, #10714 and #10708
- 10730 is designed for mounting grommets: #10704 and #10706



Part Number	Mount Material	Mount Color
10729	Steel	Black
10730	Steel	Black

10 SERIES

## 10<sup>®</sup> SERIES, BRACKET MOUNT, 2 SCREW

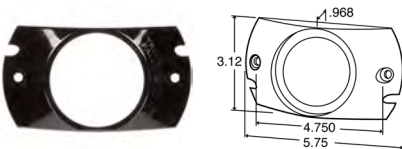

- High-impact plastic deflector mount
- Design allows surface mounting of 2-1/2" lamps
- Suitable for PC requirements on a 45-angle when using LED or incandescent PC rated/combination lamps



Part Number	Mount Material	Mount Color
10731	PC	Black
10738	PC	Gray



### 10<sup>®</sup> SERIES, BRACKET MOUNT, 2 SCREW, KIT



- Rust-resistant stainless steel mount
- Quick cam-on, cam-off lamp installation
- Suitable for PC requirements on a 45-degree angle using all 2-1/2" diameter lamps
- Mounts with screws to surface
- Model 10 kits available
- Not recommended for use with Signal-Stat LED products
- Replaces Signal-Stat 9394



Part Number	Mount Material	Mount Color	Lamp Connection	Plug Side 1	Plug Side 2	Kit Includes
10400	Stainless Steel	Silver	PL-10	PL-10	Stripped End/ Ring Terminal	10720 bracket, 94902 plug

10 SERIES

### 10<sup>®</sup> SERIES, BRACKET MOUNT, 2 SCREW, KIT



- High-impact plastic mount
- Branch deflector cams-on 2 and 2 1/2" lamps
- Requires 94924 side entry plug
- Suitable for PC requirements on a 45-degree angle when using LED or incandescent PC rated/combination lamps
- Not recommended for use with Signal-Stat LED products
- Replaces Signal-Stat 9390

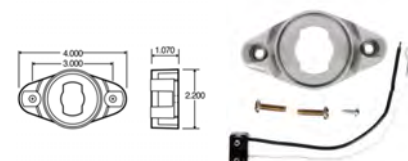

Part Number	Mount Material	Mount Color	Lamp Connection	Plug Side 1	Plug Side 2	Kit Includes
10410	PC	Gray	PL-10	PL-10	Stripped End/ Ring Terminal	10728 bracket, 94924 plug

10 SERIES

### 10<sup>®</sup> SERIES, BRACKET MOUNT, 2 SCREW, KIT



- High-impact plastic deflector mount
- Design allows surface mounting of 2-1/2" lamps
- Suitable for PC requirements on a 45-degree angle when using LED or incandescent PC rated/combination lamps



Part Number	Mount Material	Mount Color	Lamp Connection	Plug Side 1	Plug Side 2	Kit Includes
10414	PC	Gray	PL-10	PL-10	Stripped End/ Ring Terminal	10725 bracket, 10700 grommet, 94902 plug

10 SERIES

### 10<sup>®</sup> SERIES, BRACKET MOUNT, 3 SCREW



- Mounting plates can be installed into any 2" Round or 2.5" mounting holes
- Provides an easy way to upgrade incandescent lamps or problematic LED lamps to high quality Truck-Lite 33 Series and 36 Series M/C lamps, which offer Limited Lifetime Warranties
- Adapters plates utilize the same mounting holes of standard 2" and 2.5" mounting flanges
- Constructed of impact-resistant polycarbonate for added strength and reliability

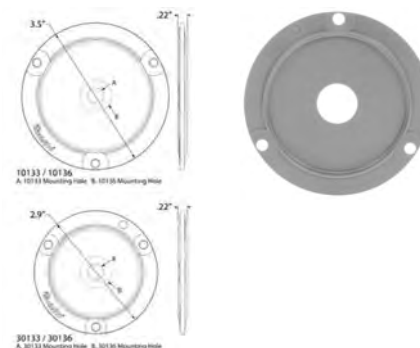

Part Number	Mount Material	Mount Color
10133	PC	Gray
10136	PC	Gray

10 SERIES

10 SERIES

### 10<sup>®</sup> SERIES, BRACKET MOUNT, 4 SCREW

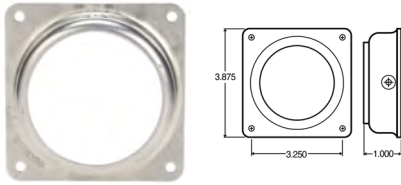

- Design allows surface mounting of 2-1/2" lamps in a grommet
- Suitable for PC requirements on a 45-degree angle when using LED or incandescent PC rated/combination lamps



Part Number	Mount Material	Mount Color
10722	Aluminum	Silver

10 SERIES

### 10<sup>®</sup> SERIES, BRACKET MOUNT, 4 SCREW

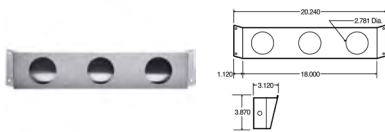

- Bracket is angle cut to fit most tanker applications
- Designed for mounting grommets requiring 2.781" hole, #10700, #10701, #10713, #10714 and #10708



Part Number	Mount Material	Mount Color
10732	Stainless Steel	Silver

10 SERIES

### 10<sup>®</sup> SERIES, CLOSED-BRACKET MOUNT, 4 SCREW, KIT

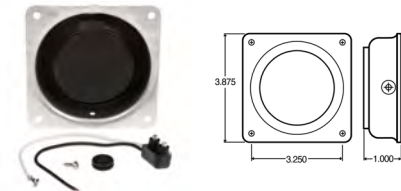

- Design allows surface mounting of 2-1/2" lamps in a grommet
- Suitable for PC requirements on a 45-degree angle when using LED or incandescent PC rated/combination lamps



Part Number	Mount Material	Mount Color	Lamp Connection	Plug Side 1	Plug Side 2	Kit Includes
10413	Aluminum	Silver	PL-10	PL-10	Stripped End/Ring Terminal	10722 bracket, 10702 grommet, 94902 plug

10 SERIES

### 10<sup>®</sup> SERIES, OPEN-BRACKET MOUNT, 4 SCREW, KIT

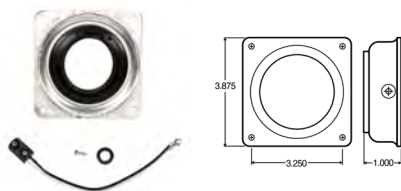

- Design allows surface mounting of 2-1/2" lamps in a grommet
- Suitable for PC requirements on a 45-degree angle when using LED or incandescent PC rated/combination lamps



Part Number	Mount Material	Mount Color	Lamp Connection	Plug Side 1	Plug Side 2	Kit Includes
10412	Aluminum	Silver	PL-10	PL-10	Stripped End/Ring Terminal	10722 bracket, 10700 grommet, 94902 plug

## 10<sup>®</sup> SERIES, DEFLECTOR MOUNT, 2 SCREW



- High-impact plastic deflector mount
- Design allows surface mounting of 2-1/2" lamps
- Suitable for PC requirements on a 45-angle when using LED or incandescent PC rated/combination lamps

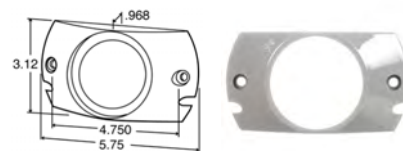

Part Number	Mount Material	Mount Color
10725	PC	Gray

10 SERIES

## 10<sup>®</sup> SERIES, FLANGE COVER



- Designed to enhance appearance of lamps
- Flange cover offers improved theft resistance
- Screws required

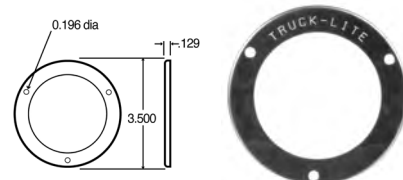

Part Number	Mount Material	Mount Color
10715	Stainless Steel	Silver

10 SERIES

## 10<sup>®</sup> SERIES, REPLACEMENT ID BAR, 4 SCREW BRACKET MOUNT



- Features rugged stainless steel or black enameled ID bar
- Lamps are mounted on 6" or 9" centers



Part Number	Mount Material	Mount Color	Centers
00794	Steel	Silver	
00798	Steel	Black	6in
00799	Steel	Black	9in

10 SERIES

## 12<sup>®</sup> SERIES, BRACKET MOUNT, 4 SCREW



- High-impact plastic branch deflector mount
- Snap-in lamp design for easy replacement
- SAE PC rated for combination clearance/marker applications
- Standard replacement on UPS models

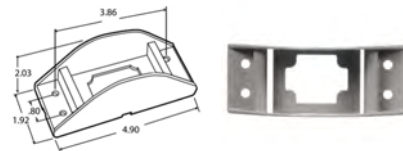

Part Number	Mount Material	Mount Color
12723	ABS	Gray
12724	ABS	Brown
12725	ABS	Black

12 SERIES

15 SERIES

## 15<sup>®</sup> SERIES, BRACKET MOUNT, 2 SCREW

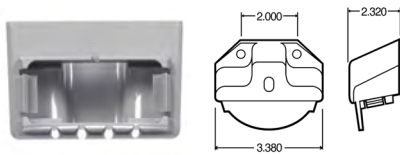

- Features snap-fit mount for quick installation and easy replacement
- Bracket may be surface mounted
- Recommended mounting locations available



Part Number	Mount Material	Mount Color
15729	PC	Gray
15730	PC	Black
15732	PC	Chrome

15 SERIES

## 15<sup>®</sup> SERIES, BRACKET MOUNT, 2 SCREW, KIT

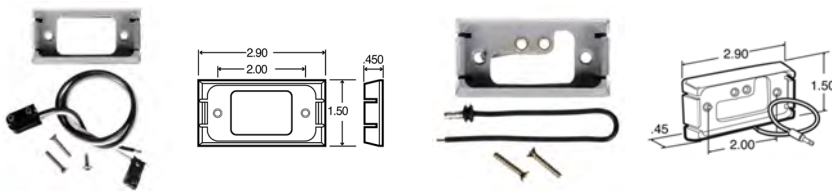

- Stylish design for contemporary look
- Sure contact, self-grounding feature
- Suitable for PC requirements on a 45-degree angle using incandescent lamps



Part Number	Mount Material	Mount Color	Lamp Connection	Plug Side 1	Plug Side 2	Kit Includes
15404	ABS	Gray	PL-10	PL-10	Stripped End/ Ground Clip	790 bracket
15405	ABS	Chrome	PL-10	PL-10	Stripped End/ Ground Clip	791 bracket
15406	ABS	Gray	.156 Bullet Hot Wire	.156 Bullet Hot Wire	Stripped End	792 bracket, 96904 plug
15407	ABS	Chrome	.156 Bullet Hot Wire	.156 Bullet Hot Wire	Stripped End	793 bracket, 96904 plug
15408	ABS	Black	.156 Bullet Hot Wire	.156 Bullet Hot Wire	Stripped End	809 bracket
15409	ABS	Chrome	.156 Bullet Hot Wire	.156 Bullet Hot Wire	Stripped End	793 bracket

15 SERIES

## 15<sup>®</sup> SERIES, BRACKET MOUNT, 6 SCREW

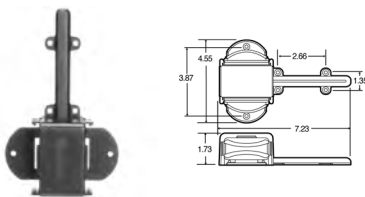

- Designed for use on most utility trailer fenders
- Available in LED or standard Model 15 kits
- Wire cover is marked in 1/2" increments for easy modifications
- LED and incandescent lamp kits are available



Part Number	Mount Material	Mount Color
15731	ABS	Black

## 15<sup>®</sup> SERIES, SURFACE MOUNT, 2 SCREW



- Extra strength plastic construction
- Easy snap-in lamp installation
- Suitable for PC requirements with incandescent lamps

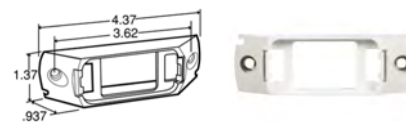

Part Number	Mount Material	Mount Color
15728	ABS	White

15 SERIES

## 15<sup>®</sup> SERIES, SURFACE MOUNT, 2 SCREW, KIT



- Extra-strength plastic construction
- Easy snap-in lamp installation
- Suitable for PC requirements with incandescent lamps

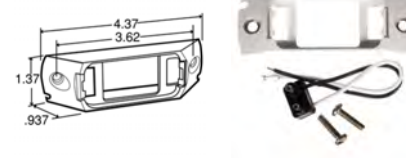

Part Number	Mount Material	Mount Color	Lamp Connection	Plug Side 1	Plug Side 2	Kit Includes
15414	ABS	White	PL-10	PL-10	Stripped End/ Ring Terminal	15728 bracket, 94924 plug

15 SERIES

## 15<sup>®</sup> SERIES, RAIL MOUNT, 2 SCREW



- Extra-strength plastic construction
- Features top cut out area on mount #15727 for narrow rail design
- Easy snap-in lamp installation
- Suitable for PC requirements with incandescent lamps

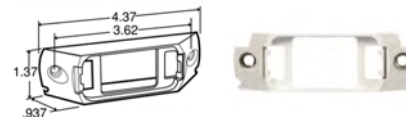

Part Number	Mount Material	Mount Color
15727	ABS	White
15733	ABS	Gray

15 SERIES

## 15<sup>®</sup> SERIES, RAIL MOUNT, 2 SCREW, KIT



- Extra-strength plastic construction
- Features top cut out area on mount #15727 for narrow rail design
- Easy snap-in lamp installation
- Suitable for PC requirements with incandescent lamps



Part Number	Mount Material	Mount Color	Lamp Connection	Plug Side 1	Plug Side 2	Kit Includes
15412	ABS	White	PL-10	PL-10	Stripped End/ Ring Terminal	15728 bracket, 94924 plug

15 SERIES

15 SERIES

## 15<sup>®</sup> SERIES, BRANCH DEFLECTOR MOUNT, 2 SCREW

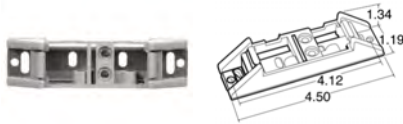

- High-impact plastic construction
- Easy Snap-On lamp installation
- Standard 1" mounting holes
- Permanently affixed hot and ground contacts
- Suitable for PC requirements on a 45-degree angle with incandescent lamps
- Not recommended for use with license lamps



Part Number	Mount Material	Mount Color
15720	ABS	Gray

15 SERIES

## 15<sup>®</sup> SERIES, BRANCH DEFLECTOR MOUNT, 2 SCREW, KIT

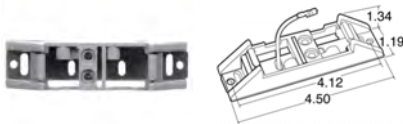

- High-impact plastic construction
- Easy Snap-On lamp installation
- Standard 1" mounting holes
- Permanently affixed hot and ground contacts
- Suitable for PC requirements on a 45-degree angle with incandescent lamps
- Not recommended for use with license lamps



Part Number	Mount Material	Mount Color	Lamp Connection	Plug Side 1	Plug Side 2	Kit Includes
15401	ABS	Gray	.156 Bullet Hot Wire	.156 Bullet Hot Wire	Stripped End	15720 bracket, 96904 plug

15 SERIES

## 15<sup>®</sup> SERIES, REPLACEMENT ID BAR, BRACKET MOUNT

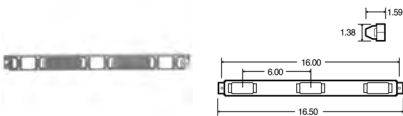

- Features rugged stainless steel ID bar designed to fit in limited mounting areas
- Lamps are mounted on 6" centers
- Direct replacement for Ford
- Fits in most narrow header rails
- Snap-lock tabs allow easy installation
- Upgrade to Truck-Lite LED lighting systems using 15 Series products



Part Number	Mount Material	Mount Color
00808	Stainless Steel	Silver

15 SERIES

## 15<sup>®</sup> SERIES, REPLACEMENT ID BAR, BRACKET MOUNT, 2 SCREW



- Features high-impact polycarbonate ID bar designed to fit in limited mounting areas
- Lamps are mounted on 6" centers
- Direct replacement for Ford
- Fits in most narrow header rails
- Snap-lock tabs allow for easy installation
- Replaces Signal-Stat 1515
- .318 Screw hole diameter
- Upgrade to Truck-Lite LED lighting systems using 15 Series products



Part Number	Mount Material	Mount Color
00817	PC	Black

## 19<sup>®</sup> SERIES, BRACKET MOUNT, 2 SCREW



- Designed for additional protection of Model 19 base mounts
- Aluminum mount designed with 3" center mounting holes
- Polycarbonate mount designed with 3" and 4.8" center mounting holes
- Not suitable for PC requirements
- Optional mounting gasket available to improve seal between lamp and body

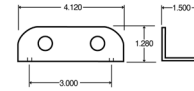

Part Number	Mount Material	Mount Color
19724	Aluminum	Silver

## 19<sup>®</sup> SERIES, BRACKET MOUNT, 2 SCREW



- Features unique plug-in design for ease of installation
- Low profile, extra strength base
- Suitable for PC requirements on a 45-degree angle
- LED and incandescent lamp kits available

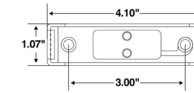

Part Number	Mount Material	Mount Color	Lamp Connection	Plug Side 1	Plug Side 2	Kit Includes
19721	PC	Gray	Hardwired	Hardwired	Stripped End	
19726	PC	Black	Hardwired	Hardwired	Stripped End	
19740	PC	Gray	Hardwired	Hardwired	.180 Bullet	

## 19<sup>®</sup> SERIES, CLOSED-BACK BRACKET MOUNT, 2 SCREW



- Features unique plug-in design for ease of installation
- Low profile, extra strength base
- Suitable for PC requirements on a 45-degree angle
- LED and incandescent lamp kits available

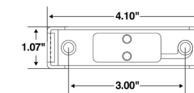

Part Number	Mount Material	Mount Color
19720	PC	Gray
19729	PC	Black

## 19<sup>®</sup> SERIES, CLOSED-BACK BRACKET MOUNT, 2 SCREW



- Features unique plug-in design for ease of installation
- Low profile, PC requirements on a 45-degree angle
- LED and incandescent lamp kits available

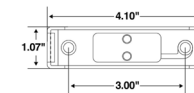

Part Number	Mount Material	Mount Color	Lamp Connection	Plug Side 1	Plug Side 2
19739	ABS	Chrome	Hardwired	Hardwired	Stripped End

19 SERIES

## 19<sup>®</sup> SERIES, OPEN-BACK BRACKET MOUNT, 2 SCREW

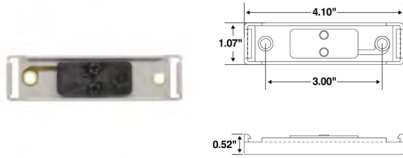

- Features unique plug-in design for ease of installation
- Low profile extra-strength base
- Suitable for PC requirements on a 45-degree angle
- LED and incandescent lamp kits available



Part Number	Mount Material	Mount Color
19728	PC	Black
19737	PC	Gray

19 SERIES

## 19<sup>®</sup> SERIES, OPEN-BACK BRACKET MOUNT, 2 SCREW

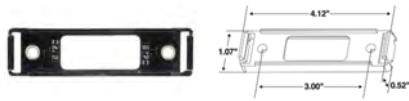

- Popular in trailer and body applications
- Features unique plug-in design for ease of installation
- Must be mounted horizontally
- Low profile extra strength base



Part Number	Mount Material	Mount Color
19748	ABS	Chrome

19 SERIES

## 19<sup>®</sup> SERIES, LAMP GUARD MOUNT, 2 SCREW

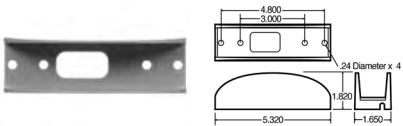

- Designed for additional protection of Model 19 base mounts
- Aluminum mount designed with 3" center mounting holes
- Polycarbonate mount designed with 3" and 4.8" center mounting holes
- Not suitable for PC requirements
- Optional mounting gasket available to improve seal between lamp and body



Part Number	Mount Material	Mount Color
19748	PC	Gray

19 SERIES

## 19<sup>®</sup> SERIES, RADIUS BASE MOUNT, 2 SCREW

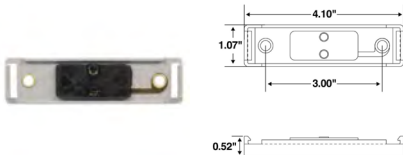

- Features unique plug-in design for ease of installation
- Low profile extra strength base
- Suitable for PC requirements on a 45-degree angle
- LED and incandescent lamp kits available



Part Number	Mount Material	Mount Color	Base Mount Radius
19722	PC	Gray	9in
19738	PC	Gray	6.25in
19750	PC	Gray	4.68in



## 19<sup>®</sup> SERIES, BRACKET MOUNT, 2 SCREW, KIT



- High-impact plastic mount
- Quick cam-on, cam-off lamp installation
- Suitable for PC requirements on a 45-degree angle using LED or incandescent PC rated/combinatin lamps
- Not recommended for use with Signal-Stat LED lamps

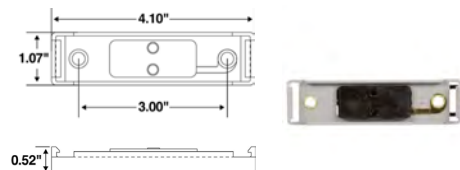

Part Number	Mount Material	Mount Color	Lamp Connection	Plug Side 1	Plug Side 2	Kit Includes
19721	PC	Clear	PL-10	PL-10	Stripped End/ Ring Terminal	
19726	PC	Gray	PL-10	PL-10	Stripped End/ Ring Terminal	

## 26 SERIES, BRACKET MOUNT, 2 SCREW



- Surface mounts on two screws at 1.5" centers
- Ground through base
- Popular for use on school and commercial buses
- Heavy duty steel and acrylic construction
- Lens attaches to base with one center screw
- Optional zinc-plated steel guard provides additional protection
- Replaces Signal-Stat 1151/1151A/9251

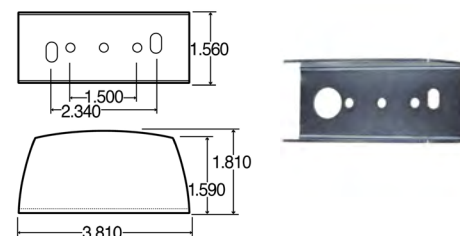

Part Number	Mount Material	Mount Color
26723	Steel	Chrome
26724	Steel	Chrome

## 26 SERIES, BRACKET MOUNT, 2 SCREW



- Designed to enhance appearance of lamps
- Corrosion resistant chrome plating
- Sleek Design
- For use with the following part numbers: 26250R, 26250Y, 26251R, 26251Y, 26270R and 26270Y



Part Number	Mount Material	Mount Color
26002	ABS	Chrome

## 26 SERIES, BRACKET MOUNT, HOOD



- Features high-impact housing with streamline design
- Mounts on 1-3/4" hole centers
- Replaces Signal-Stat 420W and 423W

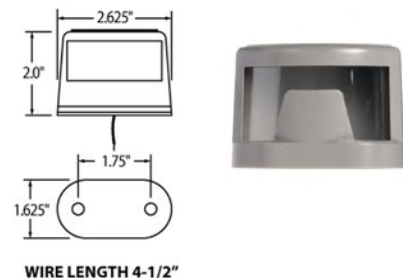

Part Number	Mount Material	Mount Color
26380	PC	Gray

30 SERIES

### 30<sup>®</sup> SERIES, BRACKET MOUNT, 2 SCREW

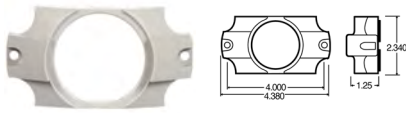

- High-impact plastic mount
- Design allows surface mounting of 2" diameter lamps
- Not recommended for PC requirements or LED applications



Part Number	Mount Material	Mount Color
30727	PC	Gray

30 SERIES

### 30<sup>®</sup> SERIES, BRACKET MOUNT, 2 SCREW

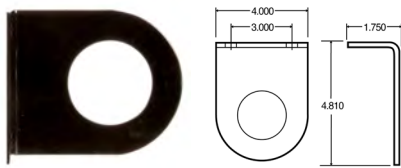

- Black epoxy painted heavy steel
- Used for mounting Model 30 grommets
- Replaces Signal-Stat 9397



Part Number	Mount Material	Mount Color
30728	Steel	Black

30 SERIES

### 30<sup>®</sup> SERIES, BRACKET MOUNT, 2 SCREW

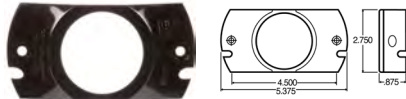

- Black epoxy painted heavy steel
- Used for mounting Model 30 grommets
- Replaces Signal-Stat 9397



Part Number	Mount Material	Mount Color
30729	PC	Black

30 SERIES

### 30<sup>®</sup> SERIES, BRACKET MOUNT, 2 SCREW



- High-impact plastic deflector mount
- Inner bracket cams-on, cams-off lamp for quick installation
- Outer bracket provides additional protection
- Not recommended for PC requirements
- Designed for use with lamp #30200R/Y or #30250R/Y



Part Number	Mount Material	Mount Color
30731	ABS	Gray

### 30<sup>®</sup> SERIES, BRACKET MOUNT, 2 SCREW



- Rust-resistant, stainless-steel mount
- Quick cam-on, cam-off lamp installation
- Meets PC requirements on a 45-degree angle
- Mounts with screws to surface, not included
- Model 30 kits available
- Not recommended for Signal-Stat LED lamps
- Replaces Signal-State 9396

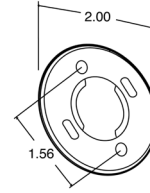

Part Number	Mount Material	Mount Color
30720	Stainless Steel	Silver

30 SERIES

### 30<sup>®</sup> SERIES, BRACKET MOUNT, 3 SCREW



- Mounting plates can be installed into any 2" round or 2.5" mounting holes
- Provides an easy way to upgrade incandescent lamps or problematic LED lamps to high quality Truck-Lite 33 Series and 36 Series M/C lamps
- Adapters plates utilize the same mounting holes of standard 2" and 2.5" mounting flanges
- Constructed of impact-resistant polycarbonate for added strength and reliability



Part Number	Mount Material	Mount Color	Exit Hole
30133	PC	Gray	0.74in
30136	PC	Gray	0.38in

30 SERIES

### 30<sup>®</sup> SERIES, BRACKET MOUNT, 4 SCREW



- High-impact plastic deflector mount
- Inner bracket cams-on, cams-off lamp for quick installation
- Outer bracket provides additional protection
- Not recommended for PC requirements
- Designed for use with lamp #30200R/Y or #30250R/Y

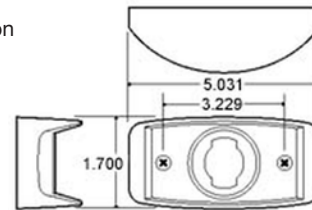

Part Number	Mount Material	Mount Color
30730	ABS	Gray

30 SERIES

### 30<sup>®</sup> SERIES, BRACKET MOUNT, 4 SCREW, KIT



- High-impact plastic deflector mount
- Inner bracket cams-on, cams-off lamp for quick installation
- Outer bracket provides additional protection
- Not recommended for PC requirements
- Designed for use with lamp #30200R/Y or #30250R/Y

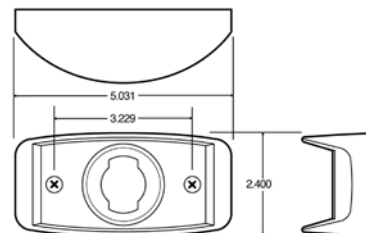

Part Number	Mount Material	Mount Color	Kit Includes
30410	ABS	Gray	30730 bracket, 30731 bracket

30 SERIES

30 SERIES

### 30<sup>®</sup> SERIES, FLANGE MOUNT, 2 SCREW, KIT

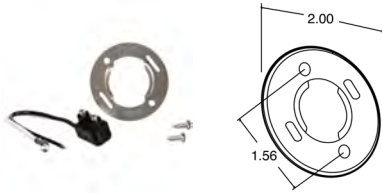

- Rust-resistant, stainless-steel mount
- Quick cam-on, cam-off lamp installation
- Meets PC requirements on a 45-degree angle
- Mounts with screws to surface, not included
- Model 30 kits available
- Not recommended for Signal-Stat LED lamps
- Replaces Signal-State 9396



Part Number	Mount Material	Mount Color	Lamp Connection	Plug Side 1	Plug Side 2	Kit Includes
30400	Stainless Steel	Silver	PL-10	PL-10	Stripped End/Ring Terminal	30720 bracket, 94902 plug

30 SERIES

### 30<sup>®</sup> SERIES, FLANGE COVER

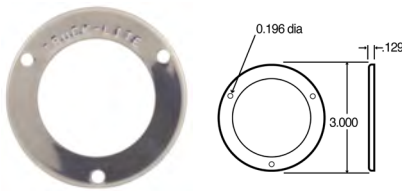

- Note: 30715 flange fits PC lamps only. 30708 flange fits P2 lamps only.
- Grommet cover designed to enhance appearance of lamps
- Flange cover offers improved theft resistance of all incandescent flanged models and 30251R/Y or 30272R/Y LED model
- Screws required



Part Number	Mount Material	Mount Color
30708	Stainless Steel	Silver

30 SERIES

### 30<sup>®</sup> SERIES, DEFLECTOR MOUNT, 2 SCREW

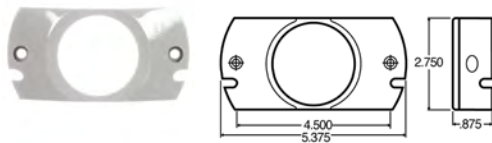

- High-impact plastic mount
- Design allows surface mounting of 2" diameter lamps
- Meets PC requirements on a 45-degree angle using LED or incandescent PC rated/combination lamp
- Replaces Signal-Stat 9395



Part Number	Mount Material	Mount Color	Application
30721	PC	Gray	
30722	PC	Gray	Not recommended for LED applications

30 SERIES

### 30<sup>®</sup> SERIES, DEFLECTOR MOUNT, 2 SCREW, KIT

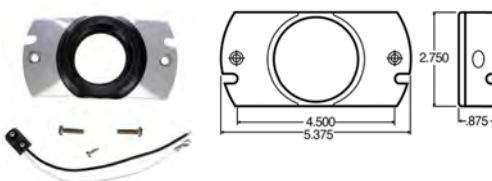

- High-impact plastic mount
- Design allows surface mounting of 2" diameter lamps
- Meets PC requirements on a 45-degree angle using LED or incandescent PC rated/combination lamp
- Replaces Signal-Stat 9395



Part Number	Mount Material	Mount Color	Lamp Connection	Plug Side 1	Plug Side 2	Kit Includes
30404	PC	Gray	PL-10	PL-10	Stripped End/Ring Terminal	94902 plug, 30721 mount, 30700 grommet

### 33® SERIES, BRACKET MOUNT, 2 SCREW



- Enables lamps to be mounted to surface, routing wiring outside vehicle, using mounting holes designed to easily retrofit 19 Series bracket installations
- High-impact plastic construction allowing use of grommet or flange mounts
- Suitable for PC lamp installation, when mounted on a 45-degree angle
- Branch Deflector Mounts (33710, 33712):
- High-impact polycarbonate construction, requires 3/4" hole for installation
- Designed to easily retrofit 19 Series bracket installations
- Suitable for PC-Rated lamps on 45 deg mounting angle

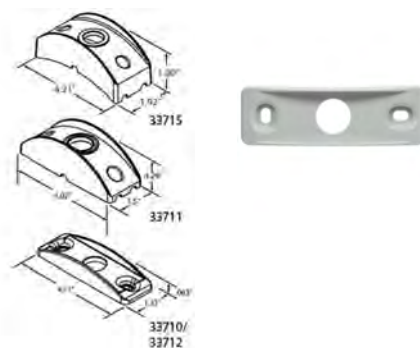

Part Number	Mount Material	Mount Color
33710	PC	White
33712	ABS	Gray

### 33® SERIES, CURVED-BRACKET MOUNT, 2 SCREW



- Enables lamps to be mounted to surface, routing wiring outside vehicle, using mounting holes designed to easily retrofit 19 Series bracket installations
- High-impact plastic construction allowing use of grommet or flange mounts
- Suitable for PC lamp installation, when mounted on a 45-degree angle
- 33715 curved deflector designed to mount on 4.6" radius corner
- High-impact polycarbonate construction, requires 3/4" hole for installation
- Designed to easily retrofit 19 Series bracket installations
- Suitable for PC-Rated lamps on 45 deg mounting angle

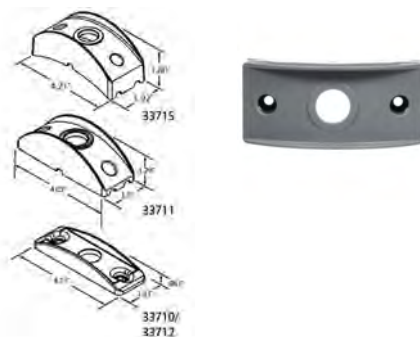

Part Number	Mount Material	Mount Color
33715	ABS	Gray

### 33® SERIES, FLANGE MOUNT



- Flush Mounts, 3/4" diameter lamps to vehicle with snap fit, no screws required
- Sealing grommets secure lamps to vehicle, while assuring a 99.9 percent leak-proof seal
- Chrome-plated flange improves the appearance on vehicle
- Suitable for PC requirements when using LED PC rated/combination lamps
- Security ring can be installed onto flange mount installations to prevent lamps from theft (US Patent 7,572,043)

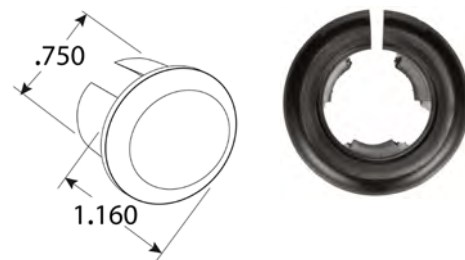

Part Number	Mount Material	Mount Color
33800	Nylon	Black
33810	Nylon	Chrome

33 SERIES

### 33<sup>®</sup> SERIES, FLANGE MOUNT BRACKET, 2 SCREW



Part Number	Mount Material	Mount Color
33805	ABS	Black



33 SERIES

### 33<sup>®</sup> SERIES, DEFLECTOR MOUNT, 2 SCREW



- Enables lamps to be mounted to surface, routing wiring outside vehicle, using mounting holes designed to easily retrofit 19 Series bracket installations
- High-impact plastic construction allowing use of grommet or flange mounts
- Suitable for PC lamp installation when mounted on a 45-degree angle
- 33715 curved deflector designed to mount on 4.6" radius corner Branch Deflector Mounts (33710, 33712)
- Designed to easily retrofit 19 Series bracket installations
- Suitable for PC-Rated lamps on 45-degree mounting angle



Part Number	Mount Material	Mount Color
33711	ABS	Gray

35 SERIES

### 35<sup>®</sup> SERIES, BRACKET MOUNT, 2 SCREW

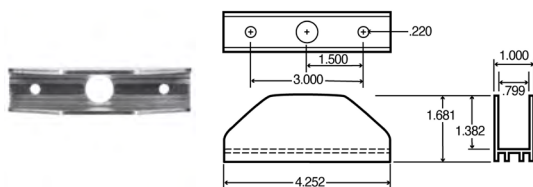

- Extruded aluminum-armored mounting bracket protects individual lamps from physical damage
- Wiring routed through .65" access hole in base of mount



Part Number	Mount Material	Mount Color
35720	Aluminum	Chrome

35 SERIES

### 35<sup>®</sup> SERIES, REPLACEMENT ID BARS, BRACKET MOUNT

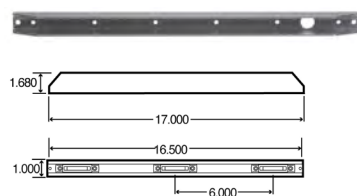

- Designed to fit applications requiring minimal space
- Slim 1" width is perfect for upper rail mounting
- Draws less current, allowing more power for other vehicle requirements



Part Number	Mount Material	Mount Color	Centers
00815	Aluminum	Silver	6 inch centers
00816	Aluminum	Silver	9 inch centers

### 36 SERIES, BRACKET MOUNT, 2 SCREW



- Side mount options can be mounted without any mounting brackets or fasteners



Part Number	Mount Material	Mount Color
36710	ABS	Gray
36711	ABS	Black

36 SERIES

### 40<sup>®</sup> SERIES, BRACKET MOUNT, 2 SCREW



- Features black painted reinforced steel
- Designed with 4-1/2" hole for mounting 4" lamps
- Available with or without flange

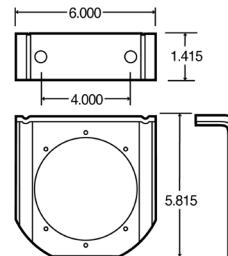

Part Number	Mount Material	Mount Color
40720	Steel	Black

40 SERIES

### 40<sup>®</sup> SERIES, BRACKET MOUNT, 2 SCREW



- Features large outer lens for greater visibility
- Includes slotted bracket for ease of installation and adjustment
- Available with enclosed housing for extra protection



Part Number	Mount Material	Mount Color
40810	Steel	Black

40 SERIES

40 SERIES

### 40® SERIES, BRACKET MOUNT, 4 SCREW

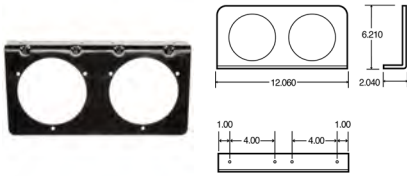

- Features black epoxy painted steel
- Designed for two 4" lamps in 4 1/2" hole
- Replaces Signal-Stat 9239



Part Number	Mount Material	Mount Color
40715	Steel	Black

40 SERIES

### 40® SERIES, BRACKET MOUNT, 9 SCREW

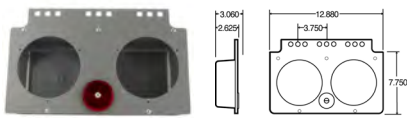

- Designed as replacement for many OEM trailer applications
- Includes red reflector
- Accepts all 4" grommet or flanged mount lamps
- Replaces Signal-Stat 9524



Part Number	Mount Material	Mount Color
40725	Steel	Gray

40 SERIES

### 40® SERIES, FLANGE MOUNT, 4 SCREW



- Features metal mounting flange with high-impact plastic module box
- Optional mounting gasket #97938 available to provide extra seal between module and body



Part Number	Mount Material	Mount Color
40721	Steel	Black

40 SERIES

### 40® SERIES, FLANGE MOUNT, 5 SCREW

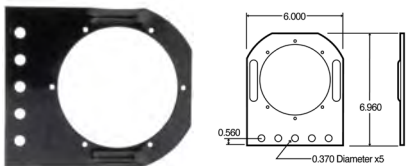

- Features black painted reinforced steel
- Designed with 4-1/2" hole for mounting 4" lamps
- Available with or without flange



Part Number	Mount Material	Mount Color
40719	Steel	Black



### 40<sup>®</sup> SERIES, LIGHT MODULE HOUSING, 4 SCREW



- Features metal mounting flange with high-impact plastic module box
- Optional mounting gasket #97938 available to provide extra seal between module and body

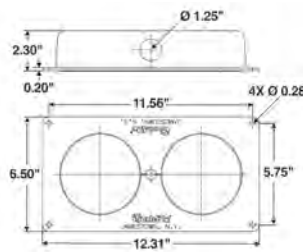

Part Number	Mount Material	Mount Color
40722	ABS	White

40 SERIES

### 40<sup>®</sup> SERIES, MODULE BRACKET, 4 SCREW



- Popular on most tanker applications
- Designed for use with two 4" and one 2-1/2" grommet mounted lamps

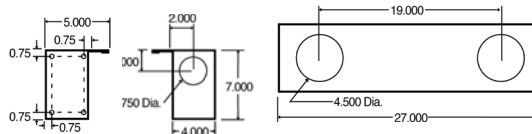

Part Number	Mount Material	Mount Color	Position
40680	Stainless Steel	Silver	LH
40681	Stainless Steel	Silver	RH

40 SERIES

### 40<sup>®</sup> SERIES, SLOTTED-BACK MOUNT, 2 SCREW



- Features large outer lens for greater visibility
- Includes slotted bracket for ease of installation and adjustment
- Available with enclosed housing for extra protection
- Part #40802 shown above
- Use part numbers 40812 and 40830 for LED versions

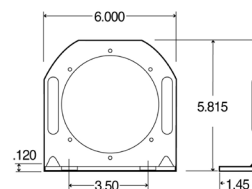

Part Number	Mount Material	Mount Color
40726	Steel	Black

40 SERIES

### 45<sup>®</sup> SERIES, LIGHT MODULE HOUSING, 4 STUD MOUNT



- Features rugged thermoplastic rubber housing
- High-impact polypropylene cover
- Unique housing offers shock absorbency and allows lamp replacement without tools



Part Number	Mount Material	Mount Color
45323	Rubber	Black

45 SERIES

SUPER 21

## SUPER 21<sup>®</sup>, BRACKET MOUNT, 2 SCREW

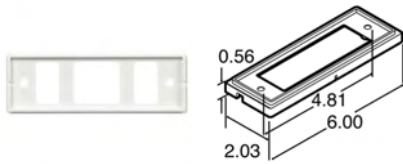

Part Number	Mount Material	Mount Color
21720	PC	White
21721	PC	Black

SUPER 21

## SUPER 21<sup>®</sup>, BRACKET MOUNT, 6 SCREW

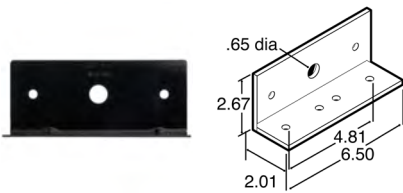

- 21722 mounting bracket features electro-painted reinforced steel
- Angle bracket is suitable for mounting the LED Model 21 horizontally
- 97034 is a self-adhesive flat gasket for various mounting applications
- 97036 is a sealing gasket for an improved seal at the rear of the lamp



Part Number	Mount Material	Mount Color
21722	Steel	Black

1 IN X 2 IN

## BRACKET MOUNT, 1" X 2", 2 SCREW

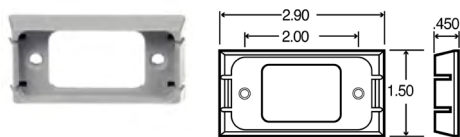

- Stylish design for contemporary look
- Sure contact, self-grounding feature
- Suitable for PC requirements on a 45-degree angle using incandescent lamps



Part Number	Mount Material	Mount Color
00790	ABS	Gray
00791	ABS	Chrome

1 IN X 2 IN

## BRACKET MOUNT, 1" X 2", 2 SCREW

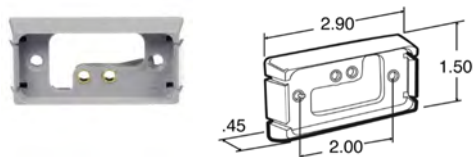

- Stylish design for contemporary look
- Sure contact, self-grounding feature
- Submersible for marine use



Part Number	Mount Material	Mount Color
00792	ABS	Gray
00793	ABS	Chrome

## BRACKET MOUNT, 1" X 2", 2 SCREW



- Stylish design for contemporary look
- Sure contact, self-grounding feature
- Suitable for PC requirements on a 45-degree angle using incandescent lamps

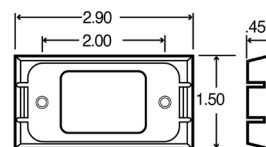

Part Number	Mount Material	Mount Color
00802	ABS	Black

1 IN X 2 IN

## BRACKET MOUNT, 1" X 2", 2 SCREW



- Stylish design for contemporary look
- Sure contact, self-grounding feature
- Submersible for marine use

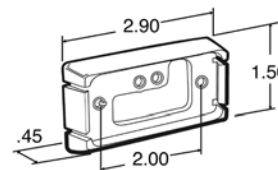

Part Number	Mount Material	Mount Color
00809	ABS	Black

1 IN X 2 IN

## BRACKET MOUNT, 1" X 2", 2 SCREW



- Designed for universal mounting applications
- Features extra-strong steel construction
- Intended for use with Model 15 license lamps

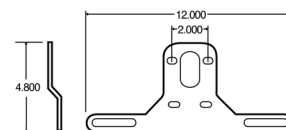

Part Number	Mount Material	Mount Color
42722	Steel	Black

1 IN X 2 IN

## BRACKET MOUNT, 1" X 2", 2 SCREW



- Compatible with LED lamps 15205, 12V, and 15905, 24V, as well as incandescent lamps 15208, 12V and 15209, 24V
- Mounts to a right angle to the license plate
- Bracket is designed to prevent light from shining to rear, positioning lighting directly onto license plate
- Snap-fit lamp mount for quick installation and easy replacement
- An addition to our Model 15 license lamp brackets
- Bracket can be used to convert Model 19 incandescent configurations to Model 15 LED/incandescent configuration

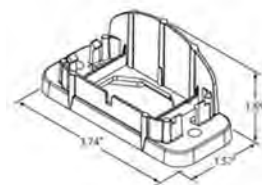

Part Number	Mount Material	Mount Color
15736	PC	Black

1 IN X 2 IN

1 IN X 2 IN

### BRACKET MOUNT, 1" X 2", 2 SCREW



- Made specifically for 36 Series Flex-Lite C/M Lamps
- Inner wings assure perfect placement every time
- Outer wings provide extra protection from branches and other objects brushing against the vehicle
- ABS allows for superior weatherability, leading to lower maintenance costs



Part Number	Mount Material	Mount Color
36705	ABS	Gray

1 IN X 3 IN

### BRACKET MOUNT, 1" X 3", 2 SCREW



Part Number	Mount Material	Mount Color
92877	PC	Black
92878	PC	Chrome

2 IN

### BRACKET MOUNT, 2", 2 SCREW



- High-impact plastic mount
- Quick cam-on, cam-off lamp installation
- Suitable for PC requirements on a 45-degree angle using LED or incandescent PC rated/combination lamps
- Not recommended for use with Signal-Stat LED lamps



Part Number	Mount Material	Mount Color
801	PC	Clear

## BRACKET MOUNT, 2", 2 SCREW



- Designed to adapt the Model 17 products to a vertical mounting surface

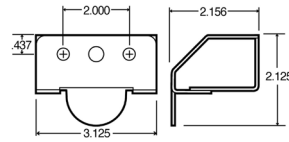

Part Number	Mount Material	Mount Color
17720	Steel	Black

2 IN

## BRACKET MOUNT, 2.5", 2 SCREW



- Black epoxy painted heavy gauge steel
- Designed for mounting grommets: #10704 and #10706



Part Number	Mount Material	Mount Color
00814	Steel	Black

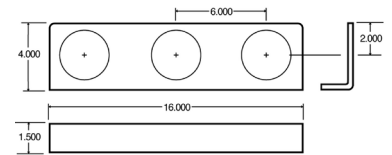

2.5 IN

## BRACKET MOUNT, 2" X 4", 2 SCREW



Part Number	Mount Material	Mount Color
92879	PC	Black
92880	PC	Chrome
92881	PC	Black



2.5 IN

2 IN X 5 IN

### BRACKET MOUNT, 2" X 5", 2 SCREW

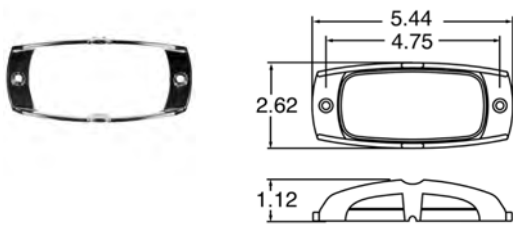

Part Number	Mount Material	Mount Color
92877	PC	Black
92878	PC	Chrome

2 IN X 6 IN

### BRACKET MOUNT, 2" X 6", 2 SCREW

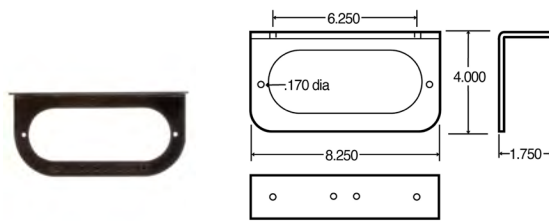

- Designed for 60 series products with grommet or flange mounts
- Available with or without flange



Part Number	Mount Material	Mount Color	
60720	Steel	Black	Flanged
60722	Steel	Black	Flat

2 IN X 6 IN

### BRACKET MOUNT, 2" X 6", 2 SCREW

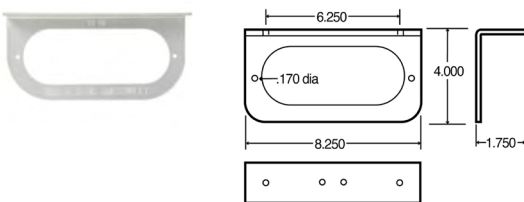

- Designed for 60 series products with grommet or flange mounts
- Available with or without flange



Part Number	Mount Material	Mount Color	
60723	Aluminum	Silver	Flanged
60724	Aluminum	Silver	Flat

### BRACKET MOUNT, 2"X 6" , 2 SCREW



- Z configuration is designed for mounting side turn lamps on most trailers
- Notched flange version offers solution for trailer frame interference
- Designed for use with grommet or flange mounted 60 series products

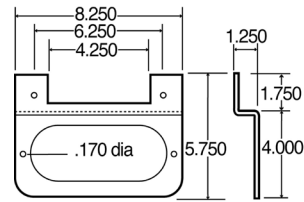

2 IN X 6 IN

Part Number	Mount Material	Mount Color	
60728	Steel	Gray	Z Configuration
60733	Steel	Gray	Notched Flange

### BRACKET MOUNT, 2"X 6" , 2 SCREW



- Z configuration is designed for mounting side turn lamps on most trailers
- Notched flange version offers solution for trailer frame interference
- Designed for use with grommet or flange mounted 60 series products

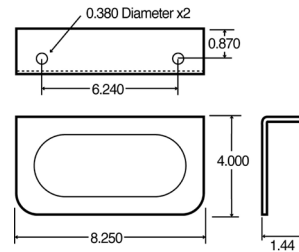

2 IN X 6 IN

Part Number	Mount Material	Mount Color
60730	Stainless Steel	Silver

### BRACKET MOUNT WITH CLAMPS, 2"X 6" , 2 SCREW



- Designed for use with grommet or flange mounted 60 series products

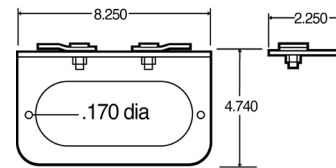

2 IN X 6 IN

Part Number	Mount Material	Mount Color
60729	Stainless Steel	Silver

2 IN X 6 IN

## BRACKET MOUNT, 2" X 6", 4 SCREW

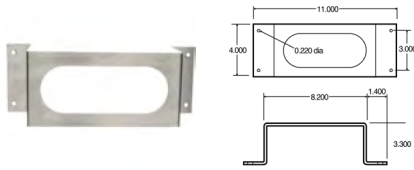

- Popular for tanker requirements
- Features stainless steel constructions
- Available in flange or standoff versions
- Designed for 60 series products with grommet mount
- Replaces Signal-Stat 9292S



Part Number	Mount Material	Mount Color
60731	Stainless Steel	Silver

2 IN X 6 IN

## THREE-LIGHT BRACKET MOUNT, 2" X 6", 2 SCREW

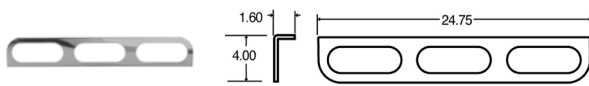

- Features bright finished stainless steel for corrosion resistance, added strength and durability
- Designs available for mounting two, three or four lamp systems
- Replaces Signal-Stat 9290S



Part Number	Mount Material	Mount Color
60738	Stainless Steel	Chrome

3 IN X 5 IN

## BRACKET MOUNT, 3" X 5", 5 SCREW

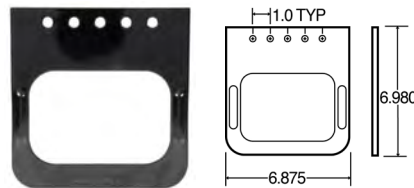

- High-impact Polypropylene Cover



Part Number	Mount Material	Mount Color
45333	PC	Black

BRACKET MOUNT

## BRACKET MOUNT, 2 SCREW

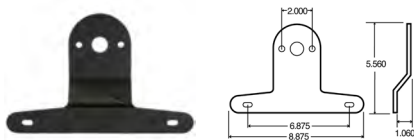

- High-impact plastic
- Universal mount
- Included in trailer lighting kit #55550



Part Number	Mount Material	Mount Color
80720	Stainless Steel	Silver
80722	Stainless Steel	Silver



## SIGNAL-STAT, BRACKET MOUNT, 2 SCREW



- 9293: For forward and back swivel on auxiliary beams
- For mounting on tubular frame or flat surface on 2" centers
- 9291: Two 1/2" mounting holes
- Size: 3-3/8" L x 1-3/16" H x 2-1/8" W



BRACKET MOUNT

Part Number	Mount Material	Mount Color
9291	Stainless Steel	Silver

## LIGHT COVER, 2" X 6", 2 SCREW



- Grommet cover features chrome-plated plastics to enhance appearance of lamps
- Flange cover provides improved theft resistance of LED lamps
- Two screws required

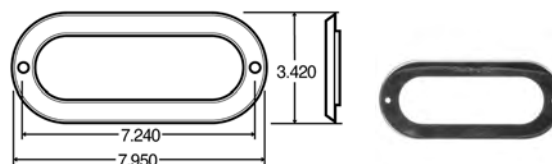

2 IN X 6 IN

Part Number	Mount Material	Mount Color
60719	Stainless Steel	Chrome

## LIGHT COVER, 2" X 6", 2 SCREW



- Grommet cover features chrome-plated plastics to enhance appearance of lamps
- Flange cover provides improved theft resistance of LED lamps
- Two screws required

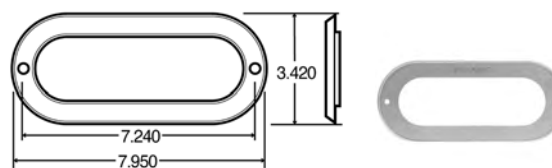

2 IN X 6 IN

Part Number	Mount Material	Mount Color
60718	Stainless Steel	Silver

## TWO-LIGHT BRACKET MOUNT, 2" X 6", 2 SCREW



- Features bright finished stainless steel for corrosion resistance, added strength and durability
- Designs available for mounting two, three or four lamp systems
- Replaces Signal-Stat 9290S

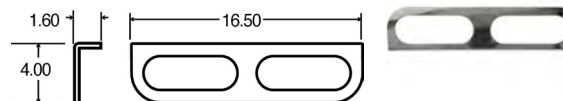

2 IN X 6 IN

Part Number	Mount Material	Mount Color
60737	Stainless Steel	Chrome

4 IN

## SECURITY MOUNT, 4"



- Helps protect LED lamps from theft, by locking them in place
- Snap-and-go installation greatly reduces installation time, eliminating the need for screw holes or mounting screws
- Fits Truck-Lite Super 44 6-Diode LED lamps



Part Number	Mount Material	Mount Color
97334	Stainless Steel	Chrome

4 IN

## SECURITY MOUNT, 4", KIT



- Helps protect LED lamps from theft, by locking them in place
- Snap-and-go installation greatly reduces installation time, eliminating the need for screw holes or mounting screws
- Fits Truck-Lite Super 44 6-Diode LED lamps



Part Number	Mount Material	Mount Color
97337	Stainless Steel	Chrome

4 IN

## FLANGE MOUNT, 4"

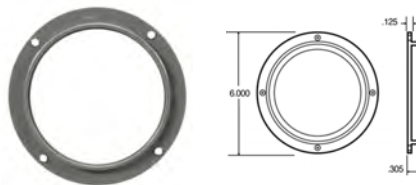

- Features high-impact plastic construction
- Converts 4-3/4" hole to a 4-1/2" hole
- Replaces Signal-Stat 9117



Part Number	Mount Material	Mount Color
50831	ABS	Gray

4 IN

## FLANGE MOUNT, 4"



- GMC# 477332(LH)
- Jeep# SF5758254(LH)
- Dodge# 4114562(RH)
- GMC# 477331(RH)
- Jeep# SF5758255(RH)
- Features universal weatherproof loom wire harness



Part Number	Mount Material	Mount Color
9288	Steel	Black

## FLANGE COVER, 4"



- Designed to enhance the appearance of lamps
- Flange cover offers improved theft resistance
- Three screws required

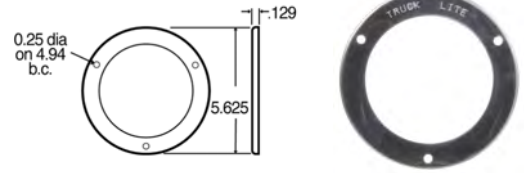

Part Number	Mount Material	Mount Color
44705	Stainless Steel	Silver
44708	Stainless Steel	Silver
44709	Stainless Steel	Black

4 IN

## FLANGE COVER, 6"



Part Number	Mount Material	Mount Color
80602	Rubber	Black



4 IN

## LATCH COVER, 3" X 5"



- Features rust-resistant black epoxy painted reinforced steel
- Mounts lamps using the 45700 grommet
- Available with or without flange
- Replaces Signal-Stat 9287



Part Number	Mount Material	Mount Color
45333	Steel	Black

## COVER, 3" X 6"



Part Number	Mount Material	Mount Color
80603	Rubber	Black





Part Number	Compatible Part Numbers	Material
88-02210	3762, 3763, 3860, 3861, 3862, 3863	Rubber



Part Number	Compatible Part Numbers	Material
88-88130	8945, 8945A	Rubber

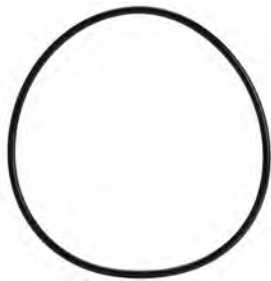

Part Number	Compatible Part Numbers	Material
9120	SS 5800 Series	Rubber



Part Number	Compatible Part Numbers	Material
9180	1204, 1205, 1233, 1235, 1203, 1203A, 1203G, 1233, 1233A	Rubber

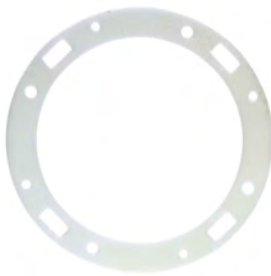

Part Number	Compatible Part Numbers	Material
9520	6503, 6503A, 6506, 90325Y, 90326R, 90326Y, 90327R, 90327Y	Foam

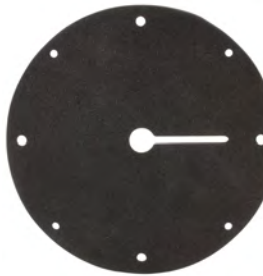

Part Number	Compatible Part Numbers	Material
9521	Arrow T/S Products	Foam



Part Number	Compatible Part Numbers	Material
9522	Shock/Mount Two Bulb	Foam



Part Number	Compatible Part Numbers	Material
9523	Shock/Mount Extended Lens	Foam



Part Number	Compatible Part Numbers	Material
07022	Cab Marker Lamp (25761Y)	Foam



Part Number	Compatible Part Numbers	Material
92808	92676Y, 92677Y	Steel



Part Number	Compatible Part Numbers	Material
97031	91002R, 91002Y, 91202R, 91202Y, 91205R, 91205Y, 91315R, 91315Y	Foam



Part Number	Compatible Part Numbers	Material
97032	15011, 15012, 15013, 15040, 15041, 15042, 15043, 15053, 15054, 15055, 15056, 15058, 15059, 15060, 15061	Foam



Part Number	Compatible Part Numbers	Material
97034	2150, 2150A, 2152, 2152A, 21001R, 21001Y, 21002R, 21002Y, 21005R, 21005Y, 21051R, 21051Y, 21056R, 21056Y, 21075R, 21075Y, 21080R, 21080Y, 21090Y, 21091Y, 21092Y, 21094Y, 21095Y, 21096Y, 21200R, 21200Y, 21201R, 21201Y, 21205R, 21205Y, 21210Y, 21217R, 21251R, 21251Y, 21253Y, 21256Y, 21275R, 21275Y, 21501R, 21501Y, 21506R, 21506Y, 21507R, 21507Y, 21880R, 21880Y, 21256R	Foam



Part Number	Compatible Part Numbers	Material
97035	35001R, 35001Y, 35080R, 35080Y, 35200R, 35200Y, 35201R, 35201Y, 35880R, 35880Y, 35890R, 35890Y	Foam



Part Number	Compatible Part Numbers	Material
97036	2150, 2150A, 2152, 2152A, 21001R, 21001Y, 21002R, 21002Y, 21005R, 21005Y, 21051R, 21051Y, 21056R, 21056Y, 21075R, 21075Y, 21080R, 21080Y, 21090Y, 21091Y, 21092Y, 21094Y, 21095Y, 21096Y, 21200R, 21200Y, 21201R, 21201Y, 21205R, 21205Y, 21210Y, 21217R, 21251R, 21251Y, 21253Y, 21256Y, 21275R, 21275Y, 21501R, 21501Y, 21506R, 21506Y, 21507R, 21507Y, 21880R, 21880Y, 21256R	Foam



Part Number	Compatible Part Numbers	Material
97038	35001R, 35001R1, 35001R3, 35001Y, 35001Y1, 35001Y3, 35080R, 35080Y, 35200R, 35200R3, 35200Y, 35200Y3, 35201R, 35201Y, 35375R, 35375Y, 35880R, 35880Y, 35890R, 35890Y	Foam



Part Number	Compatible Part Numbers	Material
97039	91241Y, 91242R, 91243Y, 91244R	Foam



Part Number	Compatible Part Numbers	Material
97046	26 Series Lamps	Foam



Part Number	Compatible Part Numbers	Material
97050	19723, 19724, 19736	Foam



Part Number	Compatible Part Numbers	Material
97073	26250R, 26250Y, 26251R, 26251Y	Foam



Part Number	Compatible Part Numbers	Material
97079	10051R, 10051R, 10051Y, 10079R, 10079Y, 10089R, 10089Y, 10090R, 10090Y, 10091R, 10091Y, 10092R, 10092Y, 10251R, 10251Y, 10271Y, 10279R, 10288R, 10288Y, 10289R, 10289Y, 10379R, 10379Y, 10389R, 10389Y, 10391R, 10391Y	Foam



Part Number	Compatible Part Numbers	Material
97080	30221R, 30221Y, 30222R, 30222Y	Foam



Part Number	Compatible Part Numbers	Material
97093	80334R, 80335R, 80336R, 80342, 80344, 80345, 81300R, 81300Y, 81301R, 81301Y	Foam

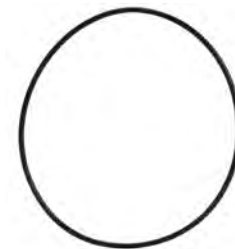

Part Number	Compatible Part Numbers	Material
97094	80334R, 80334R3, 80335R, 80336R, 80342, 80344, 80345, 81300R, 81300Y, 81301R, 81301Y	Foam



Part Number	Compatible Part Numbers	Material
97701	25766R, 25766Y	Foam



Part Number	Compatible Part Numbers	Material
97905	26760Y	Foam



Part Number	Compatible Part Numbers	Material
97921	12200C, 12200R, 12200Y, 12201R, 12201Y	Foam



Part Number	Compatible Part Numbers	Material
97925	12200C, 12200R, 12200Y, 12201R, 12201Y	Foam



Part Number	Compatible Part Numbers	Material
97927	18300R, 18300Y	Rubber

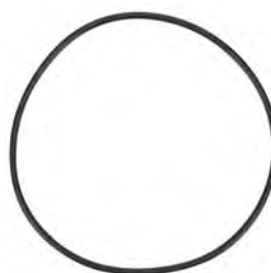

Part Number	Compatible Part Numbers	Material
97933	50800, 50801	Rubber

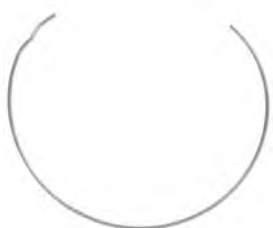

Part Number	Compatible Part Numbers	Material
97945	80302R, 80302Y, 80304, 80334R, 80335R, 80336R, 80342, 80344, 80345, 81300R, 81300Y, 81301R, 81301Y	Stainless Steel

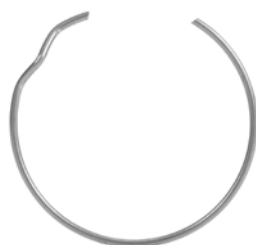

Part Number	Compatible Part Numbers	Material
97947	26740R, 26741Y	Stainless Steel



Part Number	Compatible Part Numbers	Material
97987	22002R, 22002Y, 22004R, 22004Y, 22006R, 22006Y, 22016Y, 22202R, 22202Y	Foam



Part Number	Compatible Part Numbers	Material
97706	4015, 4016, 4017, 4018, 4023, 4023Y106, 4024, 4024Y106, 4025, 4026, 4027, 4028, 5315Y101, 5316Y101	Foam

# Looking for even more product information?

Visit [truck-lite.com](http://truck-lite.com)



Powerful Search Function



360° Product Images



Easy-To-Find Replacement Parts



## BACK-UP ALARM SWITCH



- 80594 Illuminating rocker switch On-off switch for use with auxiliary lights and heated mirrors

Part Number  
80594



## WIRING, KIT



Part Number  
80593



## STONE GUARD



Part Number  
80592



## SWITCH, BLADE TERMINAL



Part Number  
97224

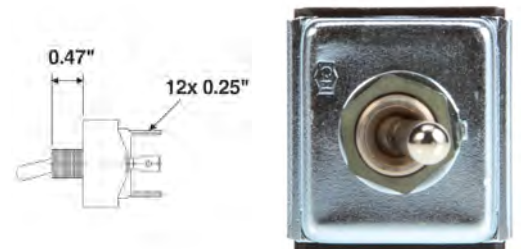

## TURN SIGNAL SWITCH MOUNTING HARDWARE



Part  
Number  
9190



## SNOW PLOW AND ATL MOUNTING HARDWARE



Part  
Number  
80840

- Kit includes a switch, a grommet that protects wiring at the switch, and a heavy-duty flasher



## SNOW PLOW AND ATL MOUNTING HARDWARE



Part  
Number  
80844



## ATL-DRL HARDWARE



Part  
Number  
80940

- DRL kit includes a switch and a heavy-duty flasher



## LIGHT BAR GUTTER HOOK MOUNT



Part  
Number  
92773



## LIGHT BAR LENS CLIP



Part  
Number  
92816



## WORK LIGHTS MOUNTING HARDWARE



Part  
Number  
95910



## MARKER CLEARANCE LIGHTS MOUNTING HARDWARE



Part  
Number  
95911



### CAB MARKER MOUNTING HARDWARE



Part Number  
97288



### WORK LIGHTS MOUNTING HARDWARE



Part Number  
97432

- Stainless steel mounting hardware
- 5/16"-18 stud Mount



### PEDESTAL LIGHTS MOUNTING HARDWARE



Part Number  
97126



### HEADLIGHT MOUNTING HARDWARE

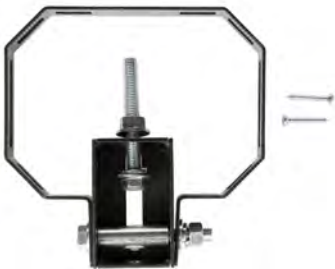

Part Number  
07168



## 10<sup>®</sup> SERIES, 2.5", OPEN BACK

- Flush mounts 2-1/2" diameter lamps
- Wide groove for panel thickness up to .250"
- Narrow groove for panel thickness up to .125"
- Suitable for PC requirements on a 45-degree angle when using LED or incandescent PC-rated/combination lamps
- Closed back versions recommended for open installation where splash plate is not used
- Replaces Signal-Stat 9119 and 9156

Part Number	Mount Material	Mount Color	Groove	Warranty
10700	PVC	Black	Wide	1 Year
10701	PVC	White	Wide	1 Year
10704	PVC	Black	Normal	1 Year
10706	PVC	White	Normal	1 Year
10708	Rubber	Black	Normal	1 Year
10713	PVC	Black	Narrow	1 Year

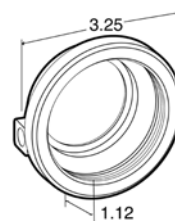

10719  
GROMMET COVER

10719  
VISION COVER



### COVERS

Part Number	Mount Material	Mount Color	Warranty
10719	Plastic	Chrome	1 Year
10740	Plastic	Chrome	1 Year

## 10<sup>®</sup> SERIES, 2.5", OPEN BACK, KIT

- Flush mounts 2-1/2" diameter lamps
- Wide groove for panel thickness up to .250"
- Narrow groove for panel thickness up to .125"
- Suitable for PC requirements on a 45-degree angle when using LED or incandescent PC-rated/combination lamps
- Closed-back versions recommended for open installation where splash plate is not used
- Replaces Signal-Stat 9119 and 9156

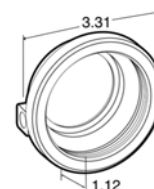

Part Number	Mount Material	Mount Color	Lamp Connection	Plug Side 1	Plug Side 2	Warranty	Kit Includes
10401	PVC	Black	PL-10	PL-10	Stripped End/Ring Terminal	1 Year	94902 plug
10403	Rubber	Black	PL-10	PL-10	Stripped End/Ring Terminal	1 Year	94902 plug

## 10<sup>®</sup> SERIES, 2.5", OPEN BACK, KIT

- Designed for recess mounting
- Suitable for PC requirements on a 45-degree angle when using LED or incandescent PC-rated/combination lamps
- Adapts to surface thickness up to .125"
- Replaces Signal-Stat 9121



Part Number	Mount Material	Mount Color	Lamp Connection	Plug Side 1	Plug Side 2	Warranty	Kit Includes
10404	PVC	Black	PL-10	PL-10	Stripped End/Ring Terminal	1 Year	94902 plug

10 SERIES

### 10<sup>®</sup> SERIES, 2.5", CLOSED BACK



- Flush mounts 2-1/2" diameter lamps
- Wide groove for panel thickness up to .250"
- Narrow groove for panel thickness up to .125"
- Suitable for PC requirements on a 45-degree angle when using LED or incandescent PC-rated/combination lamps
- Closed-back versions recommended for open installation where splash plate is not used
- Replaces Signal-Stat 9119 and 9156

Part Number	Mount Material	Mount Color	Groove	Warranty
10702	PVC	Black	Wide	1 Year
10714	PVC	Black	Narrow	1 Year
10718	Rubber	Black		1 Year

10 SERIES

### 10<sup>®</sup> SERIES, 2.5", CLOSED BACK, KIT



- Flush mounts 2-1/2" diameter lamps
- Wide groove for panel thickness up to .250"
- Narrow groove for panel thickness up to .125"
- Suitable for PC requirements on a 45-degree angle when using LED or incandescent PC-rated/combination lamps
- Closed-back versions recommended for open installation where splash plate is not used
- Replaces Signal-Stat 9119 and 9156

Part Number	Mount Material	Mount Color	Lamp Connection	Plug Side 1	Plug Side 2	Warranty	Kit Includes
10402	PVC	Black	PL-10	PL-10	Stripped End/Ring Terminal	1 Year	94902 plug

14 SERIES

### 14 SERIES, 2" X 3", OPEN BACK



- Sonically sealed lens and housing
- Features snap-in lamp with reflector
- 12V and 24V versions available
- Long-life 15,000 hour 12 volt bulb
- Grommets flush mount the lamp to vehicle
- Not suitable for PC requirements
- Replaces Signal-Stat 1017/1017A and 9138

Part Number	Mount Material	Mount Color	Warranty
14700	PVC	White	1 Year
14701	PVC	Black	1 Year

### 15<sup>®</sup> SERIES, 1" X 2", OPEN BACK

- Flush mount vinyl PVC grommet
- Mounts in panel thickness up to .250"
- Suitable for PC requirements on a 45-degree angle with incandescent lamps
- Replaces Signal-State 9362

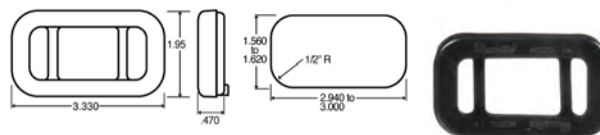

Part Number	Mount Material	Mount Color	Warranty
15702	PVC	Black	1 Year

### 30<sup>®</sup> SERIES, 2", OPEN BACK

- Flush mounts 2" diameter lamps
- Wide groove for panel thickness up to .250"
- Suitable for PC requirements when using LED or incandescent PC-rated/combination lamps
- Closed-back versions recommended for open installation where splash plate is not used
- Replaces Signal-Stat 9139



Part Number	Mount Material	Mount Color	Groove	Warranty
30700	PVC	Black		1 Year
30701	PVC	Gray		1 Year
30706	PVC	White		1 Year
30707	PVC	Gray	Wide	1 Year
30711	Rubber	Black		1 Year

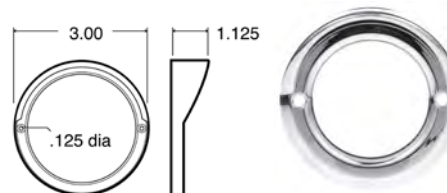

GROMMET COVERS  
30707 / 30711

### 30<sup>®</sup> SERIES, 2", OPEN BACK, KIT

- Flush mounts 2" diameter lamps
- Wide groove for panel thickness up to .250"
- Suitable for PC requirements when using LED or incandescent PC-rated/combination lamps
- Closed-back versions recommended for open installation where splash plate is not used
- Replaces Signal-Stat 9139



Part Number	Mount Material	Mount Color	Lamp Connection	Plug Side 1	Plug Side 2	Warranty	Kit Includes
30401	PVC	Black	PL-10	PL-10	Stripped End/Ring Terminal	1 Year	94902 plug

30 SERIES

### 30<sup>®</sup> SERIES, 2", CLOSED BACK

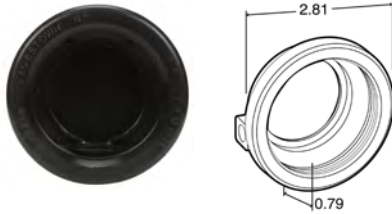

- Flush mounts 2" diameter lamps
- Wide groove for panel thickness up to .250"
- Suitable for PC requirements when using LED or incandescent PC-rated/combination lamps
- Closed-back versions recommended for open installation where splash plate is not used
- Replaces Signal-Stat 9139

Part Number	Mount Material	Mount Color	Exit Hole	Warranty
30702	PVC	Black	0.75 in	1 Year
30704	PVC	Black	0.5 in	1 Year

30 SERIES

### 30<sup>®</sup> SERIES, 2", CLOSED BACK, KIT



- Flush mounts 2" diameter lamps
- Wide groove for panel thickness up to .250"
- Suitable for PC requirements when using LED or incandescent PC-rated/combination lamps
- Closed-back versions recommended for open installation where splash plate is not used
- Replaces Signal-Stat 9139

Part Number	Mount Material	Mount Color	Lamp Connection	Plug Side 1	Plug Side 2	Warranty	Kit Includes
30402	PVC	Black	PL-10	PL-10	Stripped End/Ring Terminal	1 Year	94902 plug

33 SERIES

### 33<sup>®</sup> SERIES, 0.75", OPEN BACK

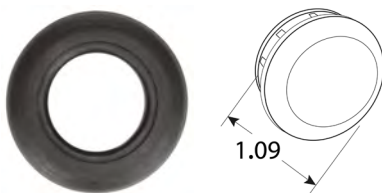

- Flush Mounts, 3/4" diameter lamps to vehicle with snap fit, no screws required
- Sealing grommets secure lamps to vehicle, while assuring a 99.9 percent leak-proof seal
- Chrome-plated flange improves the appearance on vehicle
- Suitable for PC requirements when using LED PC-rated/combination lamps
- Security ring can be installed onto flange mount installations to prevent lamps from theft (US Patent 7,572,043)

Part Number	Mount Material	Mount Color	Grommet Type	Warranty
33700	Rubber	Black		1 Year
33720	Rubber	Black	Sealing Grommet	1 Year
33725	Rubber	Black	License Grommet	1 Year
33705	Rubber	Black	Sealing Grommet	1 Year



## 33<sup>®</sup> SERIES, 0.75", OPEN BACK

- Flush Mounts, 3/4" diameter lamps to vehicle with snap fit, no screws required
- Sealing grommets secure lamps to vehicle, while assuring a 99.9% leakproof seal
- Chrome-plated flange improves the appearance on vehicle
- Suitable for PC requirements when using LED PC-rated/combination lamps
- Security ring can be installed onto flange mount installations to prevent lamps from theft (US Patent 7,572,043)



Part Number	Mount Material	Mount Color	Warranty
33702	PVC	Black	1 Year

## 40<sup>®</sup> SERIES, 4", OPEN BACK

- Flush mounts 4" diameter lamps in a 4 1/2" hole
- Designed to provide additional shock absorbency to extend lamp life
- TPR grommet designed for extreme environmental applications and eliminates outgassing

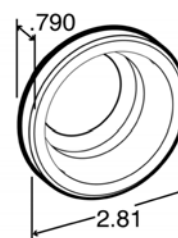

Part Number	Mount Material	Mount Color	Warranty
40700	PVC	Black	1 Year
40701	PVC	Gray	1 Year
40702	PVC	White	1 Year
40703	PVC	Brown	1 Year
40819	Rubber	Black	1 Year

## 40<sup>®</sup> SERIES, 4", OPEN BACK, KIT

- Flush mounts 4" diameter lamps in a 4 1/2" hole
- Designed to provide additional shock absorbency to extend lamp life
- TPR grommet designed for extreme environmental applications and eliminates outgassing

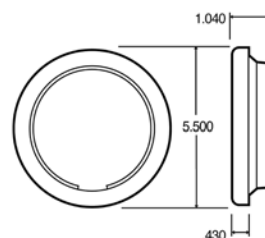

Part Number	Mount Material	Mount Color	Lamp Connection	Plug Side 1	Plug Side 2	Warranty	Kit Includes
40403	PVC	Black	PL-3	PL-3	Stripped End/Ring Terminal	1 Year	94993 plug

44 SERIES

### 44<sup>®</sup> SERIES, 4", OPEN BACK



- Designed to enhance the appearance of lamps
- Flange cover offers improved theft resistance
- Three screws required

Part Number	Mount Material	Mount Color	Warranty
44700	Plastic	Chrome	1 Year
44701	Plastic	Chrome	1 Year
44710	PVC	Black	1 Year

45 SERIES

### 45<sup>®</sup> SERIES, 3"X 5", OPEN BACK

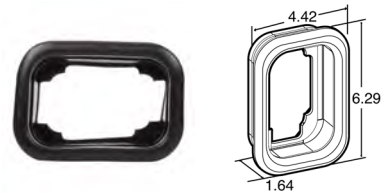

- Designed for flush mounting 45 Series lamps
- Standard grommet mounts in plate thickness of .06" to .375
- LLV grommet designed specifically for Model 45 LLV lamps mounted in plate thickness of .09" to .125"
- TPR grommet designed for extreme applications and eliminates "out gas"
- Replaces Signal-Stat 9175 and 9329

Part Number	Mount Material	Mount Color	Grommet Type	Warranty
45700	PVC	Black	Standard	1 Year
45701	PVC	Black	LLV	1 Year

60 SERIES

### 60<sup>®</sup> SERIES, 2"X 6", OPEN BACK

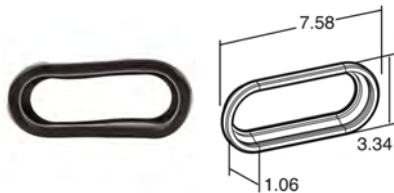

- Flush mounts the 60 Series lamps
- Provides lamps with additional shock absorbency to extend lamp life
- TPR grommet designed for extreme environmental applications and eliminates outgassing
- Semi-closed back recommended for incandescent lamps to protect lamp and wiring while allowing heat to escape
- Closed-back recommended for LED products only and protects against corrosion and stone damage

Part Number	Mount Material	Mount Color	Grommet Type	Warranty
60700	PVC	Black		1 Year
60701	PVC	Black	LLV	1 Year
60708	Rubber	Black		1 Year

## 60<sup>®</sup> SERIES, 2" X 6", OPEN BACK, KIT

- Flush mounts the 60 Series lamps
- Provides lamps with additional shock absorbency to extend lamp life
- TPR grommet designed for extreme environmental applications and eliminates outgassing
- Semi-closed back recommended for incandescent lamps to protect lamp and wiring while allowing heat to escape
- Closed-back recommended for LED products only and protects against corrosion and stone damage



Part Number	Mount Material	Mount Color	Lamp Connection	Plug Side 1	Plug Side 2	Warranty	Kit Includes
60403	PVC	Black	PL-3	PL-3	Stripped End/Ring Terminal	1 Year	94993 plug

## 60<sup>®</sup> SERIES, 2" X 6", CLOSED BACK

- Flush mounts the 60 Series lamps.
- Provides lamps with additional shock absorbency to extend lamp life.
- TPR grommet designed for extreme environmental applications and eliminates outgassing.
- Semi-closed back recommended for incandescent lamps to protect lamp and wiring while allowing heat to escape.
- Closed-back recommended for LED products only and protects against corrosion and stone damage.



Part Number	Mount Material	Mount Color	Warranty
60704	PVC	Black	1 Year

# HARNESSES SYSTEMS & WIRING

## 88 SERIES HARNESSES

Pages 390-398

SERIES	PAGES
Main Cables	390-392
S/T/T Harnesses	393-394
License Harnesses	395
ABS Harnesses	395
ID Harnesses	395-397
Marker & Clearance Harnesses	398

## 50 SERIES HARNESSES

Pages 399-407

SERIES	PAGES
Main Cables	399
S/T/T Harnesses	400-401
Turn Signal Harnesses	402
ID Harnesses	403
ABS Harnesses	403
Marker & Clearance Harnesses	404-407

**PLUGS**

**Pages 408-427**

**STRINGS**

**Pages 428-429**

**SOCKETS**

**Pages 430-431**

**NOSE BOXES**

**Page 432**

**NOSE BOX ACCESSORIES**

**Pages 433-434**

**RECEPTACLES**

**Pages 435-437**

**TRAILER CORDS**

**Page 438**

**TRAILER CONNECTOR CABLE PLUGS**

**Page 439**

**JUNCTION BOXES**

**Pages 440-442**

**JUNCTION BOX ACCESSORIES**

**Pages 443-445**

**CONDUCTOR FITTINGS & CLIPS**

**Pages 446-447**

**HEAT SHRINK TUBING & WIRE SPLICES**

**Page 448**

**FUSES**

**Page 449**

# HOW TO SELECT SIZE OF ELECTRIC CABLE

Voltage drop is the primary consideration in selecting the proper electrical wire size. The length of wire in a circuit is the major contributing factor to voltage drop. The table below may be used in determining adequate wire gauge sizes for specific lengths of cable when the amperage requirements are known.

Example: A lamp is 38 ft. from the power source and requires 10 amperes. This figure, when rounded upwards to the nearest column heading given in the table, is 40 ft. The wire gauge in the “40-ft. Column” corresponding to 10 amperes is No. 12.

## Total length of cable in circuit from battery to most distant lamp

### 12 Volt System

Amperes (Approx.)	Up To 30 Feet	40 Feet	50 Feet	60 Feet	80 Feet	100 Feet	120 Feet
	Gauge		Gauge	Gauge	Gauge	Gauge	Gauge
1.0	14	14	14	14	14	14	14
2	14	14	14	14	14	14	14
3	14	14	14	14	14	14	12
4	14	14	14	14	14	12	12
5	14	14	14	14	12	12	12
6	14	14	14	14	12	12	10
7	14	14	14	12	12	10	10
8	14	14	12	12	10	10	10
10	14	12	12	12	10	10	8
11	14	12	12	10	10	8	8
12	14	12	12	10	10	8	8
15	12	12	10	10	8	8	8
18	12	10	10	8	8	8	8
20	12	10	10	8	8	8	6
25	12	10	8	8	8	6	6
30	12	10	8	8	8	6	6
35	12	10	8	8	6	6	6

\*Recommended minimum wire gauge size for stop light and ground circuits.

- Single trailer (up to 50' length)
- Doubles trailer (2-28' lengths)
- Doubles trailer (2-40' lengths)
- Triples trailer (3-28' lengths)

Stop Light (Red)

- 12 Gauge
- 12 Gauge
- 10 Gauge
- 10 Gauge

Ground (White)

- 10 Gauge
- 10 Gauge
- 8 Gauge
- 8 Gauge

Cable size gauge no. (Copper)	length of wire in feet	Maximum current carrying capacity with 0.5 volt drop	wire resistance ohms ( $\Omega$ ) per foot
20 Ga.	10 Ft.	4.74 Amps	0.01054 $\Omega$ /ft.
18 Ga.	10 Ft.	7.53 Amps	0.00663 $\Omega$ /ft.
16 Ga.	10 Ft.	11.98 Amps	0.00417 $\Omega$ /ft.
14 Ga.	10 Ft.	19.05 Amps	0.00262 $\Omega$ /ft.
12 Ga.	10 Ft.	30.30 Amps	0.00165 $\Omega$ /ft.
10 Ga.	10 Ft.	48.16 Amps	0.00103 $\Omega$ /ft.
8 Ga.	10 Ft.	76.59 Amps	0.00065 $\Omega$ /ft.

### SAE J560 Standards Conductor Identification

Wire Color	Lamp and Signal Circuits	
Wht	White	Ground return to towing vehicle
Blk	*Black	Clearance, side marker & license plate lamps
Yel	Yellow	Left hand turn signal & hazard signal lamps
Red	Red	Stop lamps and antilock devices
Grn	Green	Right hand turn signal & hazard signal lamps
Brn	*Brown	Tail, clearance, side marker lamps & identification lamps
Blu	Blue	Auxiliary/ABS power

\*It is recommended to balance the circuits as practicable.

Note: This table gives you the resistance of wire per foot so with ohms law  $V=I \times R$  you can calculate voltage drops on any of the above wire gauges at any current level and length. For example, voltage drop in 50 ft. 10 AWG wire with 20 amp load is  $V=20 \text{ amp} \times (0.00103 \Omega / \text{ft.}) \times 50 \text{ ft.} = 1.03 \text{ volts}$ . Be sure to include both the positive and negative leads when calculating total wire length.

## Voltage Drop/Foot/Ampere

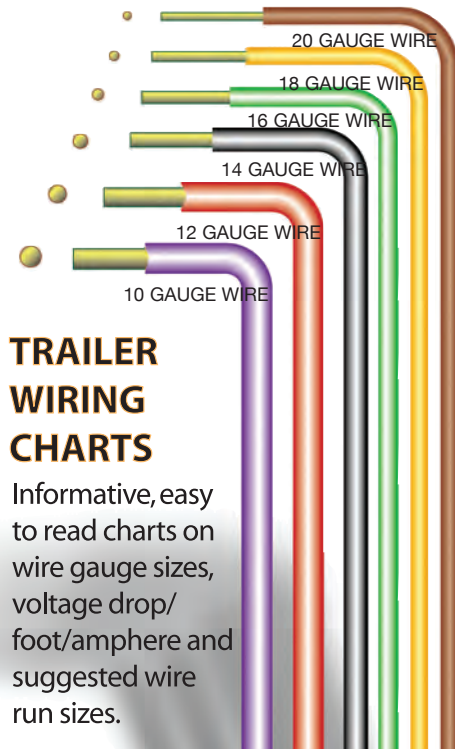
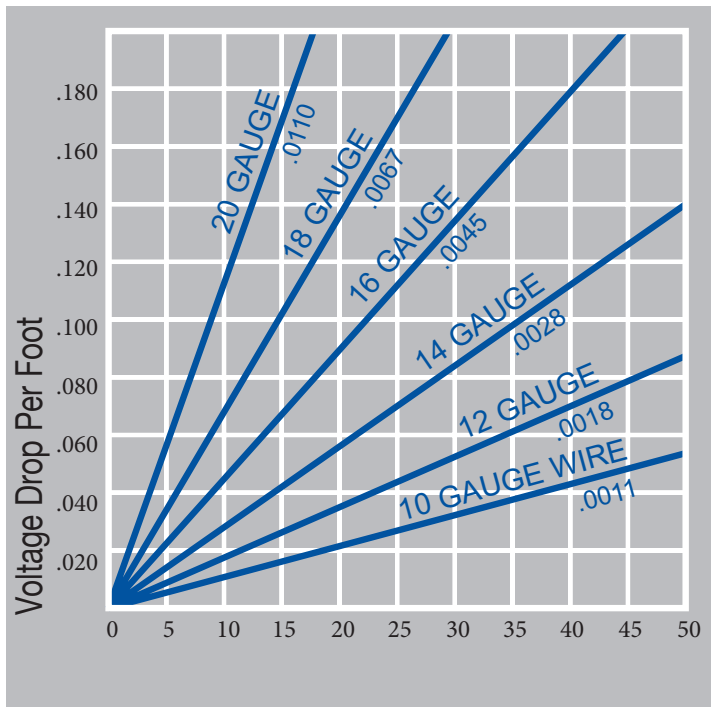

## Wire Size

**TOTAL FOOTAGE OF WIRE FROM POWER SOURCE TO THE MOST DISTANT ELECTRIC LAMP**

24 VOLT SYSTEM (AMPERES)	12 VOLT SYSTEM (AMPERES)	10'	20'	30'	40'	50'	60'	70'	80'	90'	100'
		GAUGE	GAUGE	GAUGE	GAUGE	GAUGE	GAUGE	GAUGE	GAUGE	GAUGE	GAUGE
2.0	1.0	18	18	18	18	18	18	18	18	18	18
3.0	1.5	18	18	18	18	18	18	18	18	18	18
4.0	2.0	18	18	18	18	18	18	18	16	16	16
6.0	3.0	18	18	18	18	18	16	16	16	14	14
8.0	4.0	18	18	18	16	16	16	14	14	14	12
10.0	5.0	18	18	18	16	14	14	14	12	12	12
12.0	6.0	18	18	16	16	14	14	12	12	12	12
14.0	7.0	18	18	16	14	14	12	12	12	10	10
16.0	8.0	18	16	16	14	12	12	12	10	10	10
20.0	10.0	18	16	14	12	12	12	10	10	10	10
22.0	11.0	18	16	14	12	12	10	10	10	10	8
24.0	12.0	18	16	14	12	12	10	10	10	8	8
30.0	15.0	18	14	12	12	10	10	10	8	8	8
36.0	18.0	16	14	12	10	10	8	8	8	8	8
40.0	20.0	16	12	12	10	10	8	8	8	8	6

BULK CABLE

## BULK CABLE

	Part Number	Plug Side 2	Length	Gauge	Wire Type	Warranty
	52700	Blunt Cut	12000in	8/10/12	GPT	1-Year

88 SERIES

## 88 SERIES, MAIN CABLE, 6 CONDUCTOR

- Custom length available in 12” increments

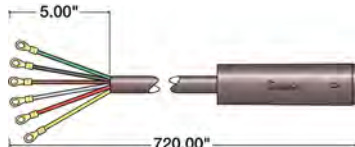
	Part Number	Wire Color	Wire Gauge	Length	Warranty
	88601	Black, Brown, Green, Red, Yellow, White	10	715in	5-Year

MAIN CABLES

88 SERIES

## 88 SERIES, MAIN CABLE, 7 CONDUCTOR

- Dimensions “A” indicated standard stocked length harness
- Custom length available in 12” increments

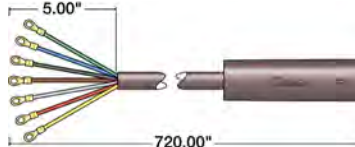
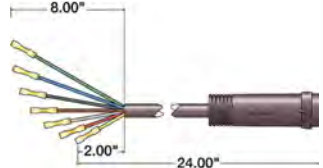
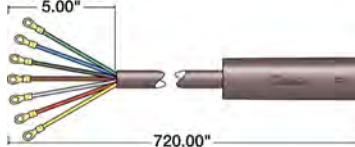
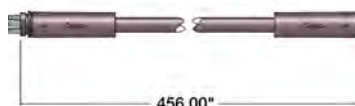
	Part Number	Wire Color	Wire Gauge	Length	Warranty
	88701	Black, Brown, Blue, Green, Red, Yellow, White	10 12	715in	5-Year
	88703	Black, Brown, Blue, Green, Red, Yellow, White	8 10 12	715in	5-Year
	88810	Black, Brown, Blue, Green, Red, Yellow, White	10 12	22in	5-Year
	88820	Black, Brown, Blue, Green, Red, Yellow, White	8 10 12	456in	5-Year

MAIN CABLES



## 88 SERIES, MAIN CABLE, 7 CONDUCTOR, INTEGRATED NOSE BOX

- Dimensions "A" indicated standard stocked length harness
- Custom length available in 12" increments

	Part Number	Wire Color	Wire Gauge	Length	Warranty
	50776	Black, Brown, Blue, Red, White, Yellow	8 10 12	72in	5-Year
	89810	Black, Brown, Blue, Green, Red, Yellow, White	10 12	28in	5-Year
	50969	Black, Brown, Blue, Green, Red, Yellow, White	8 10 12	14in	5-Year
	88892	Black, Brown, Blue, Green, Red, Yellow, White	8 10 20	180in	5-Year

## 88 SERIES, MAIN CABLE, 7 CONDUCTOR, INTEGRATED NOSE BOX W/DROPOUTS

- Custom length available in 12" increments

	Part Number	Wire Color	Wire Gauge	Length	Warranty
	88896	Black, Brown, Blue, Green, Red, Yellow, White	10 8 20	27in	5-Year

## 88 SERIES, MAIN CABLE, 7 CONDUCTOR, W/BREAKOUTS

- Dimensions "A" indicated standard stocked length harness
- Custom length available in 12" increments

	Part Number	Wire Color	Wire Gauge	Length	Warranty
	88750	Black, Brown, Blue, Green, Red, Yellow, White	10 12	744in	5-Year
	88751	Black, Brown, Blue, Green, Red, Yellow, White	8 10 12	744in	5-Year
	89751	Black, Blue, Brown, Green, Red, Yellow, White	8 10 12	744in	5-Year

## 88 SERIES, MAIN CABLE, 7 CONDUCTOR, ADAPTORS

- Custom length available in 12" increments

	Part Number	Wire Color	Wire Gauge	Length	Warranty
	88905	Black, Brown, Blue, Green, Red, Yellow, White	8 10 12	48in	5-Year
	88896	Black, Brown, Blue, Green, Red, Yellow, White	10 8 20	27in	5-Year
	88900	Black, Brown, Blue, Green, Red, Yellow, White	8 10 12	18in	5-Year

88 SERIES

REAR HARNESS

88 SERIES

REAR HARNESS

# 88 SERIES, TURN SIGNAL | LICENSE, RIGHT ANGLE PL-3 / FEMALE .180 BULLET

88 SERIES

S/T/T HARNESS

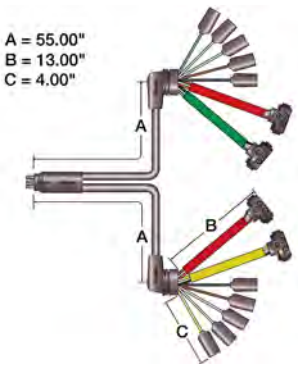
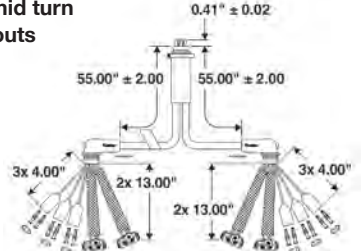
	Part Number	Wire Color	Wire Gauge	Length	Position	Warranty
 <p>A = 55.00" B = 13.00" C = 4.00"</p>	88910	Black, Brown, Green, Red, Yellow, White	14	55in	Rear	5 Year
<p>w/o mid turn dropouts</p>  <p>0.41" ± 0.02 55.00" ± 2.00 55.00" ± 2.00 2x 13.00" 2x 13.00" 3x 4.00" 3x 4.00"</p>	88915	Black, Brown, Green, Red, Yellow, White	14	55in	Rear	5 Year

# 88 SERIES, TURN SIGNAL | LICENSE, FIT 'N FORGET / FEMALE .180 BULLET



88 SERIES

S/T/T HARNESS

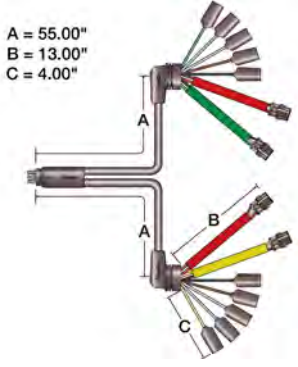
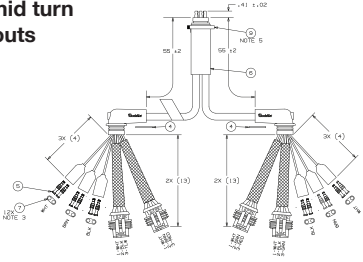
	Part Number	Wire Color	Wire Gauge	Length	Position	Warranty
 <p>A = 55.00" B = 13.00" C = 4.00"</p>	88930	Black, Brown, Green, Red, Yellow, White	14	55in	Rear	5 Year
<p>w/o mid turn dropouts</p>  <p>0.41" ± 0.02 55.00" ± 2.00 55.00" ± 2.00 2x 13.00" 2x 13.00" 3x 4.00" 3x 4.00"</p>	88932	Black, Brown, Green, Red, Yellow, White	14	55in	Rear	5 Year

**88 SERIES, STOP/TURN/TAIL | LICENSE, w/ABS  
RIGHT ANGLE PL-3 / FEMALE .180 BULLET**

88 SERIES

S/T/T HARNESS

AUX / ABS

	Part Number	Wire Color	Wire Gauge	Length	Position	Warranty
<p>A = 55.00" B = 13.00" C = 4.00" D = 10.00"</p>	88911	Black, Blue, Brown, Green, Red, Yellow, White	14	55in	Rear	5 Year

**88 SERIES, STOP/TURN/TAIL | LICENSE, w/ABS  
FIT 'N FORGET / FEMALE .180 BULLET**



88 SERIES

S/T/T HARNESS

AUX / ABS

	Part Number	Wire Color	Wire Gauge	Length	Position	Warranty
<p>A = 55.00" B = 13.00" C = 4.00" D = 10.00"</p>	88931	Black, Blue, Brown, Green, Red, Yellow, White	14	55	Rear	5 Year

### 88 SERIES, LICENSE HARNESS

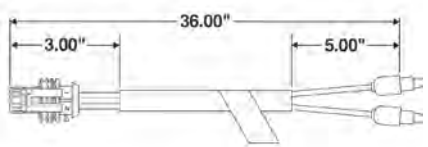
	Part Number	Wire Color	Wire Gauge	Length	Warranty
	88357	Black, White	14	36in	5 Year

88 SERIES

LICENSE HARNESS

### 88 SERIES, ABS HARNESS

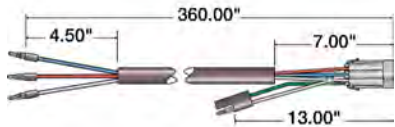
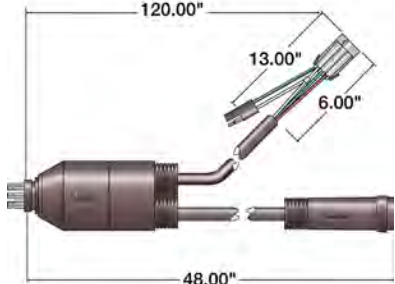
	Part Number	Wire Color	Wire Gauge	Length	Warranty
	88100	Blue, Red, White	12	348.5in	5 Year
	88902	Black, Brown, Blue, Green, Red, Yellow, White	8 10 12	18in	5 Year

88 SERIES

ABS HARNESS

### 88 SERIES, ID/LICENSE HARNESS

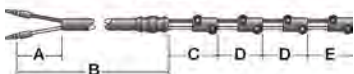
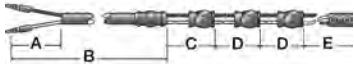
	Part Number	Number of Plugs	Wire Color	Wire Gauge	Length	Position	Warranty
<p>A = 4.00" B = 60.00" C = 6.00" D = 15.00" E = 20.00"</p> 	88308	4	Brown, White	14	56in	Lower	5 Year
<p>A = 4.00" B = 60.00" C = 6.00" D = 14.25" E = 19.50"</p> 	88338	4	Black, White	14	56in	Lower	5 Year



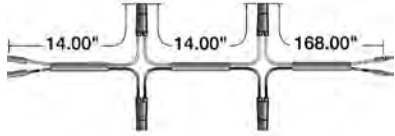

88 SERIES

ID HARNESS

### 88 SERIES, ID HARNESS, REAR

	Part Number	Number of Plugs	Wire Color	Wire Gauge	Length	Position	Warranty
	95809	3	Brown, White	14	56in	Lower	5 Year

### 88 SERIES, ID HARNESS, LOWER

	Part Number	Number of Plugs	Wire Color	Wire Gauge	Length	Position	Warranty
<p>A = 4.00" B = 60.00" C = 6.00" D = 15.00"</p> 	88300	3	Brown, White	14	56in	Lower	5 Year
<p>A = 4.00" B = 60.00" C = 6.00" D = 8.25"</p> 	88367	3	Black, White	14	56in	Lower	5 Year
<p>A = 4.00" B = 192.00" C = 6.00" D = 8.25"</p> 	88368	3	Black, White	14	188in	Lower	5 Year
<p>A = 4.00" B = 192.00" C = 6.00" D = 14.25"</p> 	88372	3	Black, White	14	56in	Lower	5 Year

88 SERIES

ID HARNESS

88 SERIES

ID HARNESS

### 88 SERIES, ID HARNESS, UPPER

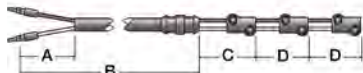
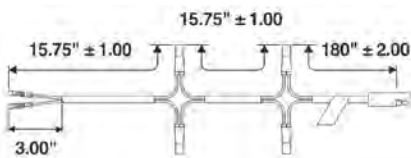
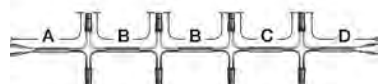
	Part Number	Number of Plugs	Wire Color	Wire Gauge	Length	Position	Warranty
<p>A = 4.00" B = 192.00" C = 6.00" D = 15.00"</p> 	88301	3	Brown, White	14	188in	Upper	5 Year
	88358	4	Black, White	14	207.63in	Upper	1 Year
<p>A = 50.00" B = 14.00" C = 50.00" D = 144.00"</p> 	95879	8	Black, White	14	265in	Upper	5 Year

88 SERIES

ID HARNESS

### 88 SERIES, JUNCTION BOX ADAPTOR

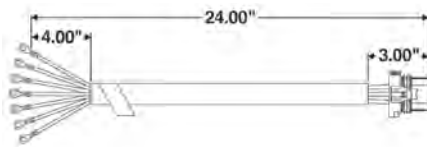
	Part Number	Number of Plugs	Wire Color	Wire Gauge	Length	Position	Warranty
	88824	1	Black, Brown, Blue, Green, Red, Yellow, White	14	17in	Upper	1 Year

88 SERIES

JUNCTION BOX ADAPTOR

# 88 SERIES, MARKER/CLEARANCE HARNESSES

88 SERIES  
MARKER/CLEARANCE

	Part Number	Number of Plugs	Wire Color	Wire Gauge	Length	Position	Warranty
<p>A = 4.00" B = 2.00" 24.00"</p>	88303	2	Brown, White	14	18in		5 Year
<p>A = 4.00" B = 2.00" 36.00"</p>	88307	2	Brown, White	14	36in		5 Year
<p>4.00" 12.00" 4.75"</p>	88342	2	Black, White	14	1.25in		5 Year
<p>A = 5.00" B = 4.00" 24.00"</p>	88373	2	Brown, White	14	24in		5 Year
<p>A = 4.50" B = 6.50" C = 24.00" D = 4.50"</p>	88385	2	Brown, White	14	19.5in		5 Year
<p>A = 18 - 636" 4.00" 4.75"</p>	88401	2	Black, White	14	39.25in		5 Year
<p>A = 1.63" B = 4.00" 12.00"</p>	88377	2	Black, White	16	6in		5 Year



## 50 SERIES, MAIN CABLE, 6 CONDUCTOR

- A range of custom length harnesses are available in 12" increments

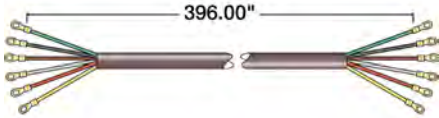
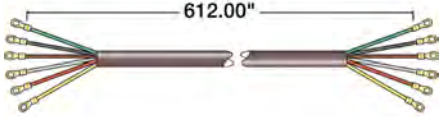
	Part Number	Wire Color	Wire Gauge	Length	Warranty
	50133	Black, Brown, Green, Red, Yellow, White	10 12	387in	5-Year
	50151	Black, Brown, Green, Red, Yellow, White	10 12	603in	5-Year

50 SERIES

MAIN CABLES

## 50 SERIES, MAIN CABLE, 7 CONDUCTOR

- A range of custom length harnesses are available in 12" increments

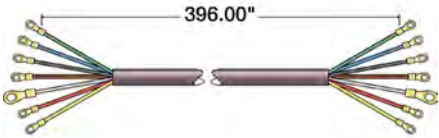
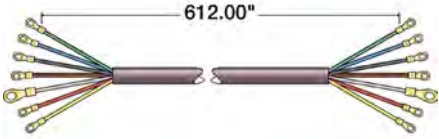
	Part Number	Wire Color	Wire Gauge	Length	Warranty
	52733	Black, Brown, Blue, Green, Red, Yellow, White	10 12	387in	5-Year
	52751	Black, Brown, Blue, Green, Red, Yellow, White	10 12	603in	5-Year

50 SERIES

MAIN CABLES

# 50 SERIES, STOP/TURN/TAIL HARNESS





• A range of custom length harnesses are available in 12" increments

	Part Number	Number of Plugs	Wire Color	Wire Gauge	Length	Position	Warranty
	50200	2	Black, Brown, Green, Red, White	14	72in	Right Hand Side	5-Year
	50201	2	Black, Brown, Red, Yellow, White	14	72in	Left Hand Side	5-Year
	50202	2	Black, Brown, Green, Red, White	14	156in	Right Hand Side	5-Year
	50203	2	Black, Brown, Red, Yellow, White	14	156in	Left Hand Side	5-Year
	50240	2	Black, Brown, Green, Red, White	16	72in	Right Hand Side	5-Year
	50241	2	Black, Brown, Green, Red, White	16	72in	Left Hand Side	5-Year
	50282	2	Black, Brown, Yellow, Red, White	16	95in	Right Hand Side	1-Year
	50283	2	Black, Brown, Yellow, Red, White	16	95in	Left Hand Side	1-Year

50 SERIES  
S/T/T HARNESS

## 50 SERIES, STOP/TURN/TAIL HARNESSES (CONTINUED)

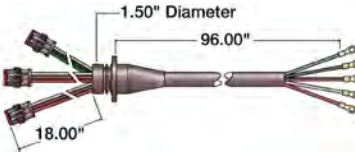
- A range of custom length harnesses are available in 12" increments

	Part Number	Number of Plugs	Wire Color	Wire Gauge	Length	Position	Warranty
	50325	1	Black, Red, White	14	180in		5-Year
	50338	1	Black, Red, White	14	456in		5-Year
	51270	3	Black, Brown, Green, Red, White	16	96in	Right Hand Side	5-Year
	51271	3	Black, Brown, Green, Red, White	16	96in	Left Hand Side	5-Year
	51325	1	Black, Red, White	14	180in		5-Year



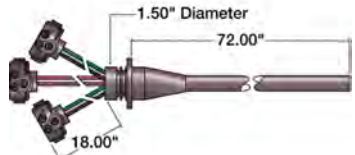
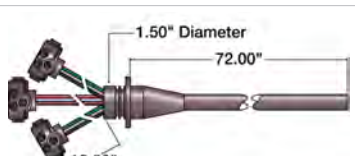
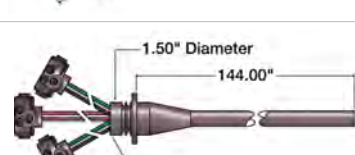
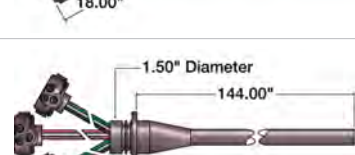

## 50 SERIES, STOP/TURN/TAIL | BACK-UP HARNESSES

- A range of custom length harnesses are available in 12" increments

	Part Number	Number of Plugs	Wire Color	Wire Gauge	Length	Position	Warranty
	50204	3	Black, Brown, Green, Red, White	14	72in	Right Hand Side	5-Year
	50205	3	Black, Brown, Red, Yellow, White	14	72in	Left Hand Side	5-Year
	50250	3	Black, Brown, Red, Yellow, White	14	139.5in	Left Hand Side	5-Year
	50251	3	Black, Brown, Green, Red, White	14	139.5in	Right Hand Side	5-Year

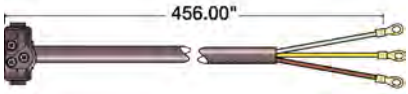

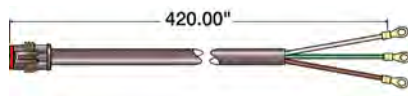

## 50 SERIES, TURN/TAIL HARNESS

• A range of custom length harnesses are available in 12" increments

	Part Number	Number of Plugs	Wire Color	Wire Gauge	Length	Position	Warranty
	50266	1	Brown, Yellow, White	14	451.5in	Right Hand Side	5-Year
	50267	1	Brown, Yellow, White	14	451.5in	Left Hand Side	5-Year
	51344	1	Brown, Green, White	14	420in	Right Hand Side	5-Year
	51345	1	Brown, Yellow, White	14	420in	Left Hand Side	5-Year

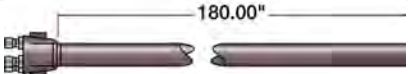
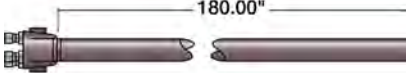
## 50 SERIES, TURN SIGNAL HARNESS

• A range of custom length harnesses are available in 12" increments

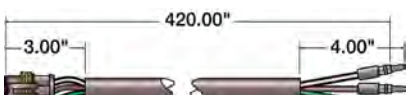
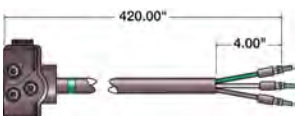
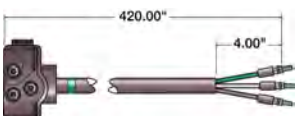
	Part Number	Number of Plugs	Wire Color	Wire Gauge	Length	Position	Warranty
	50342	1	Brown, Green, White	14	180in	Right Hand Side	5-Year
	50343	1	Brown, Green, White	14	180in	Left Hand Side	5-Year
	50344	1	Black, Green, White	14	456in	Right Hand Side	5-Year
	50345	1	Black, Green, White	14	456in	Left Hand Side	5-Year
	51342	2	Brown, Green, White	16	413in	Right Hand Side	5-Year
	51343	2	Brown, Green, White	16	413in	Left Hand Side	5-Year
	51355	2	Brown, Green, White	14	416in	Left Hand Side	5-Year
	51356	2	Brown, Green, White	14	416in	Right Hand Side	5-Year

50 SERIES



TURN/TAIL HARNESS

50 SERIES

TURN SIGNAL HARNESS

## 50 SERIES, ID HARNESS

- A range of custom length harnesses are available in 12" increments

	Part Number	Number of Plugs	Wire Color	Wire Gauge	Length	Position	Warranty
	50300	3	Brown, White	14	36in		5-Year
	50301	3	Brown, White	14	288in		5-Year
	50334	3	Brown, White	14	324in		5-Year

## 50 SERIES, ID | LICENSE HARNESS

- Dimensions "A" indicate standard stocked length harness
- A range of custom length harnesses are available in 12" increments

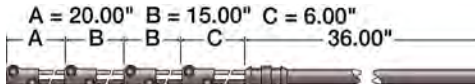
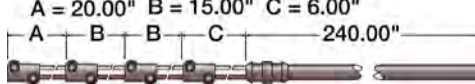
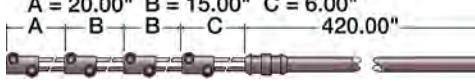
	Part Number	Number of Plugs	Wire Color	Wire Gauge	Length	Position	Warranty
	50308	4	Brown, White	14	36in	Lower	5-Year
	50335	4	Brown, White	14	240in	Upper	5-Year
	50341	4	Brown, White	14	420in	Upper	5-Year

## 50 SERIES, ABS HARNESS

- Dimensions "A" indicate standard stocked length harness
- A range of custom length harnesses are available in 12" increments

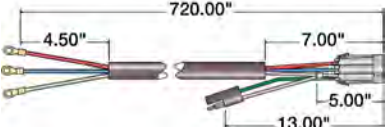
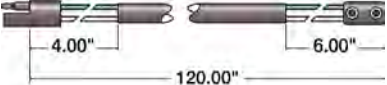
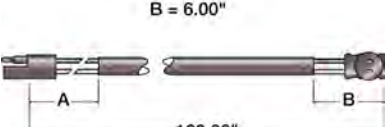
	Part Number	Number of Plugs	Wire Color	Wire Gauge	Length	Position	Warranty
	52100	2	Blue, Red, White	12	708.5in		5-Year
	52200	2	Green, White	14	110in		5-Year
	52203	2	Green, White	14	86in		5-Year

50 SERIES

ID HARNESS

50 SERIES

ID | LICENSE HARNESS

50 SERIES

ABS HARNESS

# 50 SERIES, MARKER/CLEARANCE | STOP/TURN/TAIL HARNESS

- A range of custom length harnesses are available in 12" increments

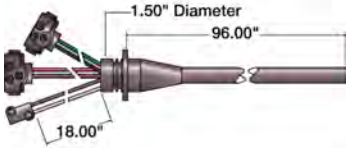
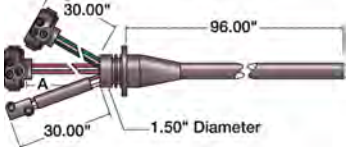







	Part Number	Number of Plugs	Wire Color	Wire Gauge	Length	Position	Warranty
	50208	3	Black, Brown, Green, Red, White	14	96in	Right Hand Side	5-Year
	50209	3	Black, Brown, Red, Yellow, White	14	96in	Left Hand Side	5-Year
	50210	3	Black, Brown, Green, Red, White	14	192in	Right Hand Side	5-Year
	50211	3	Black, Brown, Red, Yellow, White	14	192in	Left Hand Side	5-Year
	50230	3	Black, Brown, Green, Red, White	14	180in	Right Hand Side	5-Year
	50231	3	Black, Brown, Red, Yellow, White	14	180in	Left Hand Side	5-Year
	50242	3	Black, Brown, Green, Red, White	16	96in	Right Hand Side	5-Year
	50243	3	Black, Brown, Green, Red, White	16	96in	Left Hand Side	5-Year

50 SERIES

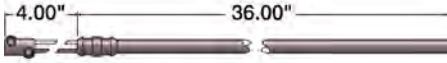
M/C | S/T/T HARNESS













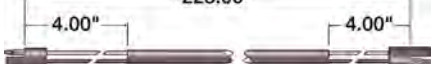

# 50 SERIES, MARKER/CLEARANCE HARNESS, 1 PLUG

- A range of custom length harnesses are available in 12" increments

	Part Number	Number of Plugs	Wire Color	Wire Gauge	Length	Position	Warranty
	50303	1	Black, White	14	72in		5-Year
	50304	1	Black, White	14	168in		5-Year
	50305	1	Black, White	14	456in		5-Year
	50307	1	Black, White	14	36in		5-Year
	50310	1	Black, White	14	336in		5-Year
	50351	1	Black, White	14	720in		5-Year
	50373	1	Black, White	14	72in		5-Year
	50374	1	Black, White	14	168in		5-Year
	50375	1	Black, White	14	456in		5-Year
	50376	1	Black, White	14	336in		5-Year

# 50 SERIES, MARKER/CLEARANCE HARNESS, 2 PLUG

• A range of custom length harnesses are available in 12" increments

	Part Number	Number of Plugs	Wire Color	Wire Gauge	Length	Position	Warranty
	50309	2	Brown White	14	168in		5-Year
	50319	2	Brown White	14	336in		5-Year
	50321	2	Brown White	14	252in		5-Year
	50324	2	Brown White	14	300in		5-Year
	50331	2	Brown White	14	384in		5-Year
	50350	2	Brown White	14	132in		5-Year
	50356	2	Brown White	14	220in		5-Year
	50377	2	Brown White	14	168in		5-Year
	50383	2	Brown White	14	132in		5-Year
	50384	2	Brown White	14	252in		5-Year
	50385	2	Brown White	14	384in		5-Year
	51409	2	Black White	14	184in		5-Year
	87357	2	Black White	14	406in		5-Year
	87358	2	Brown White	14	406in		5-Year

50 SERIES

MARKER/CLEARANCE HARNESS



## 50 SERIES, MARKER/CLEARANCE HARNESS, 3 PLUG

- A range of custom length harnesses are available in 12" increments

	Part Number	Number of Plugs	Wire Color	Wire Gauge	Length	Position	Warranty
	50322	3	Brown White	14	300in		5-Year
	50357	3	Brown White	14	100in		5-Year
	50381	3	Brown White	14	336in		5-Year
	50382	3	Brown White	14	300in		5-Year
	51375	3	Brown White	14	116in		5-Year
	50367	3	Black White	14	36in	Lower	5-Year
	50368	3	Black White	14	288in	Upper	5-Year

## 50 SERIES, MARKER/CLEARANCE HARNESS, 5 PLUG

- Dimensions "A" indicate standard stocked length harness
- A range of custom length harnesses are available in 12" increments

	Part Number	Number of Plugs	Wire Color	Wire Gauge	Length	Position	Warranty
<p>A = 20.00" B = 15.00" C = 6.00"</p> 	50302	5	Brown White	14	240in		5-Year
<p>A = 50.00" B = 10.00" C = 6.00"</p> 	50388	5	Brown White	14	240in		5-Year

PLUGS

## PLUG DUMMY, .180 RECEPTACLE

	Part Number	Warranty
	97002	1-Year

PLUGS

## PLUG, 19 SERIES HOT WIRE

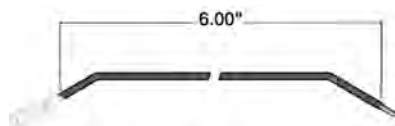
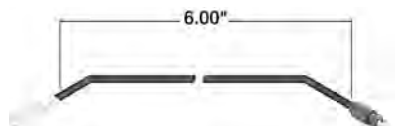

	Part Number	Plug Side 2	Wire Length	Number of Wires	Wire Type	Warranty
	96904	Stripped End	6in	1	GPT	1-Year
	96919	.180 Bullet	6in	1	GPT	1-Year

PLUGS

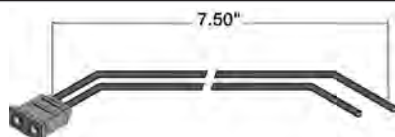
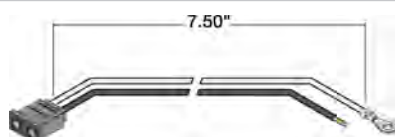
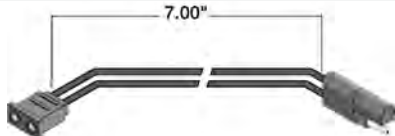
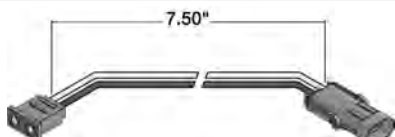
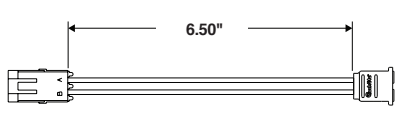
## PLUG, 19 SERIES MALE PIN

	Part Number	Plug Side 2	Wire Length	Number of Wires	Wire Type	Warranty
	94727	Blunt Cut	7.5in	2	GPT	1-Year
	94729	Stripped End/ Ring Terminal	7.5in	2	GPT	1-Year
	94821	.180 Bullet/ Female .180 Bullet	7in	2	GPT	1-Year
	95332	Packard Connector 12010973	7.5in	2	GPT	1-Year
	96248	Packard Connector 12010973	6.5in	2	GPT	1-Year

## PLUG, 2 POSITION .180 BULLET

	Part Number	Plug Side 2	Wire Length	Number of Wires	Wire Type	Warranty
	94811	Blunt Cut	50in	2	GPT	1-Year
	94812	Blunt Cut	50in	2	GPT	1-Year
	94813	Blunt Cut	50in	2	GPT	1-Year

PLUGS

## PLUG, 2 MALE BLADE TERMINAL

	Part Number	Plug Side 2	Wire Length	Number of Wires	Wire Type	Warranty
	94954	2 Female Blade Terminal	12.06in	2	GPT	1-Year

PLUGS

## PLUG, 3 BLADE TERMINAL

	Part Number	Plug Side 2	Wire Length	Number of Wires	Wire Type	Warranty
	9260	Stripped End	14in	3	GPT	1-Year

PLUGS

### PLUG, 3 FEMALE BLADE TERMINALS

	Part Number	Plug Side 2	Wire Length	Number of Wires	Wire Type	Warranty
	9183	Stripped End	7.5in	3		1-Year

### PLUG, 3 PIN FEMALE CONNECTOR 174921

	Part Number	Plug Side 2	Wire Length	Number of Wires	Wire Type	Warranty
	95119	Stripped End	7.25in	2	GPT	1-Year

### PLUG, 3 POSITION CONNECTOR 282105

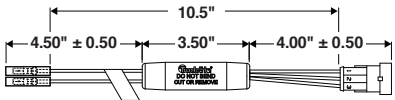
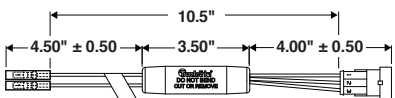
	Part Number	Plug Side 2	Wire Length	Number of Wires	Wire Type	Warranty
	97437	2 Female .180 Bullet Terminals	10.5in	5	GPT	1-Year
	97364	2 Female .180 Bullet	10.5in	5	GPT	1-Year

# PLUG, 3 POSITION CONNECTOR 282105| FIT N' FORGET S.S.

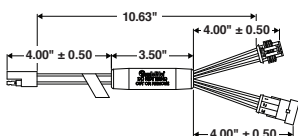
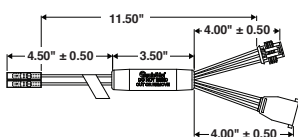
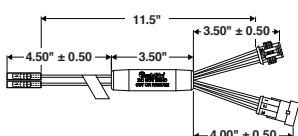
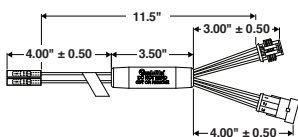
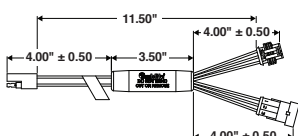
	Part Number	Plug Side 2	Wire Length	Number of Wires	Wire Type	Warranty
	97340	2 Position Plug	10.63in	8	GPT	1-Year
	97342	Female .180 Bullet	11.5in	8	GPT	1-Year
	97349	Female .180 Bullet	11.5in	8	GPT	1-Year
	97345	Female .180 Bullet	11.5in	8	GPT	1-Year
	97365	2 Position Plugs	11.5in	8	GPT	1-Year

# PLUG, 5 FEMALE BLADE TERMINALS

	Part Number	Plug Side 2	Wire Length	Number of Wires	Wire Type	Warranty
	9185	Blunt Cut	12in	5	GPT	1-Year

PLUGS

## PLUG, 5 PIN PACKARD CONNECTOR 12084891

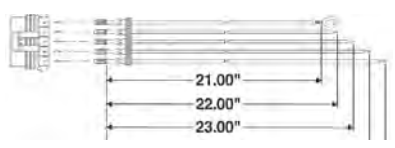
	Part Number	Plug Side 2	Wire Length	Number of Wires	Wire Type	Warranty
	9470	Stripped End/ Ring Terminal	21in	5	GPT	1-Year

PLUGS

## PLUG, DEUTSCH CONNECTOR

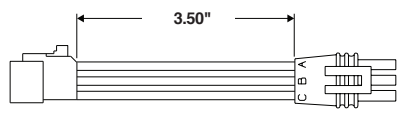
	Part Number	Plug Side 2	Wire Length	Number of Wires	Wire Type	Warranty
	94236	Packard Connector 12015793	3.5in	3	GPT	1-Year

## PLUG, FEMALE .180 BULLET

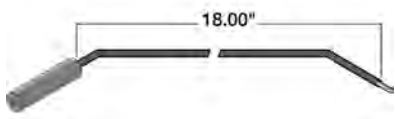
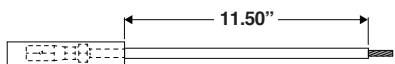
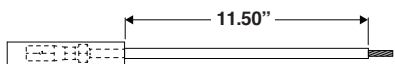
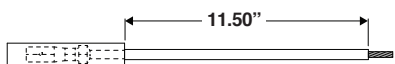
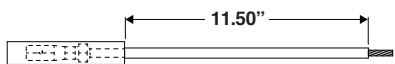
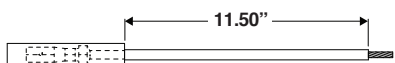
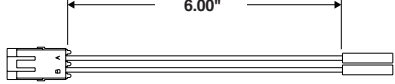
	Part Number	Plug Side 2	Wire Length	Number of Wires	Wire Type	Warranty	Wire Color
	94923	Stripped End	19in	1	GPT	1-Year	
	95121	Stripped End	11.5in	1	SXL	1-Year	Black
	95122	Stripped End	11.5in	1	SXL	1-Year	White
	95123	Stripped End	11.5in	1	SXL	1-Year	Red/White
	95124	Stripped End	11.5in	1	SXL	1-Year	Green
	95125	Stripped End	11.5in	1	GPT	1-Year	Purple
	96253	Packard Connector 12010973	6in	2	GPT	1-Year	

## PLUG, FEMALE MALE PIN



	Part Number	Plug Side 2	Wire Length	Number of Wires	Wire Type	Warranty
	96106	.180 Bullet Ring Terminal	5.9in	2	GPT	1-Year
	96107	Stripped End Ring Terminal	9.84in	3	GPT	1-Year
	96108	Stripped End Ring Terminal	9.84in	2	GPT	1-Year
	96251	.180 Bullet Female .180 Bullet Packard Connector 12010973	4.5in	4	GPT	1-Year

## PLUG, FEMALE PL-2

	Part Number	Plug Side 2	Wire Length	Number of Wires	Wire Type	Warranty
	94789	Fit 'N Forget S.S.	8in	2	GPT	Lifetime

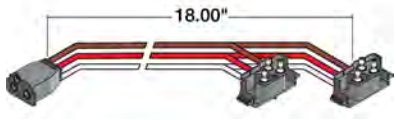
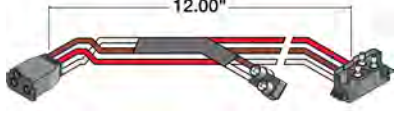

## PLUG, FEMALE PL-3

	Part Number	Plug Side 2	Wire Length	Number of Wires	Wire Type	Warranty
	94706	Fit 'N Forget S.S.	8in	3	GPT	Lifetime
	94750	Right Angle PL-3 / Right Angle PL-3	18in	3	GPT	1-Year
	94751	Right Angle PL-3/ PL-10	12in	5	GPT	1-Year
	94769	2 Fit 'N Forget S.S.	8in	6	GPT	Lifetime
	94770	Fit 'N Forget S.S.	19in	5	GPT	Lifetime
	94932	Right Angle PL-3 / Right Angle PL-3	10in	6	GPT	1-Year

PLUGS

## PLUG, FEMALE PL-3 | RIGHT ANGLE PL-3

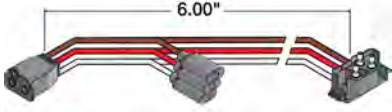
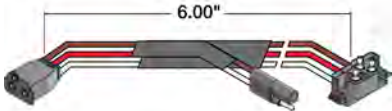
	Part Number	Plug Side 2	Wire Length	Number of Wires	Wire Type	Warranty
	94760	Female .156 Bullet	6in	6	GPT	1-Year
	94853	2 Position Plug	6in	5	GPT	1-Year

PLUGS

## PLUG, FEMALE RIGHT ANGLE .180 BULLET TERMINAL

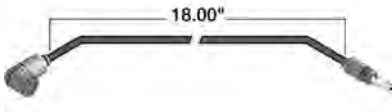
	Part Number	Plug Side 2	Wire Length	Number of Wires	Wire Type	Warranty
	94922	Blunt Cut	18in	1	GPT	1-Year
	95051	.180 Bullet	18in	1	GPT	1-Year

PLUGS

## PLUG, FEMALE TA-1415

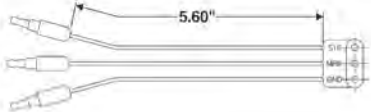
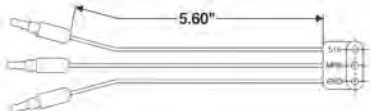
	Part Number	Plug Side 2	Wire Length	Number of Wires	Wire Type	Warranty
	9462	.180 Bullet Ring Terminal	5.6in	3	GPT	1-Year
	9463	.180 Bullet Ring Terminal	5.6in	3	GPT	1-Year

PLUG, FIT 'N FORGET 4 PIN S.S.

PLUGS

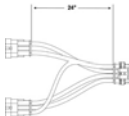
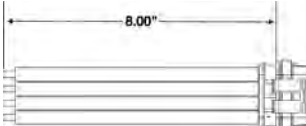
	Part Number	Plug Side 2	Wire Length	Number of Wires	Wire Type	Warranty
	94966	LED Super Seal/ 3 Position Connector 282105	24in	4	GPT	1-Year
	94831	Stripped End	8in	4	GPT	1-Year

PLUG, FIT 'N FORGET M/C

PLUGS

	Part Number	Plug Side 2	Wire Length	Number of Wires	Wire Type	Warranty
	93745	Female PL-10	4in	2	GPT	Lifetime
	94609	Blunt Cut	10in	2	GPT	1-Year
	94624	Packard Connector 12010973	11.5in	2	GPT	Lifetime
	94718	.180 Bullet   Ring Terminal	5in	2	GPT	Lifetime
	94736	.180 Bullet	18in	2	GPT	Lifetime
	94861	Heat Shrink Splic- es Ring Terminal	5in	2	GPT	Lifetime
	94862	.180 Bullet Ring Terminal	5in	2	GPT	Lifetime

PLUG, FIT 'N FORGET M/C(CONTINUED)

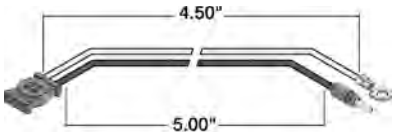
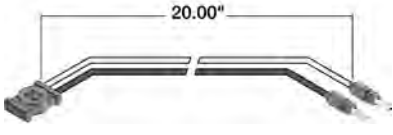
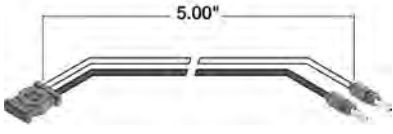
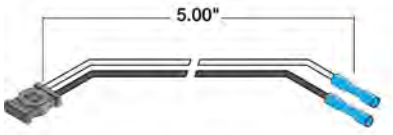
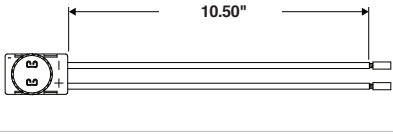
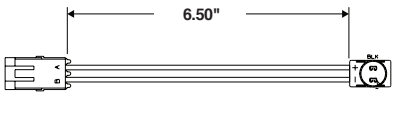
	Part Number	Plug Side 2	Wire Length	Number of Wires	Wire Type	Warranty
	94888	.156 Bullet/Ring Terminal	5in	2	GPT	Lifetime
	95306	.180 Bullet	20in	2	GPT	Lifetime
	97005	.180 Bullet	5in	2	GPT	Lifetime
	97006	Heat Shrink Splices	5in	2	GPT	Lifetime
	94237	Stripped End	10in	2	GPT	1-Year
	96252	Packard Connector 12124582	6.5in	2	GPT	1-Year

PLUG, FIT 'N FORGET S.S.

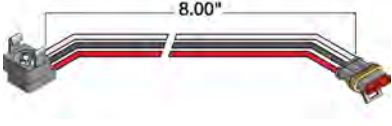
	Part Number	Plug Side 2	Wire Length	Number of Wires	Wire Type	Warranty
	94707	Stripped End Ring Terminal	8in	3	GPT	Lifetime
	94759	Stripped End Ring Terminal	8in	2	GPT	Lifetime
	94766			3	GPT	1-Year
	95001	Male Pin	8in	3	GPT	Lifetime
	95002	Male Pin	13in	6	GPT	Lifetime
	95220	Stripped End Ring Terminal	8.5in	3	GPT	1-Year
	95399	3 Position Connector 282105	12in	6	GPT	Lifetime
	95424	.180 Bullet	8in	3	GPT	Lifetime
	96247	.180 Bullet Female .180 Bullet Packard Connector 12010973	4.5in	4	GPT	1-Year

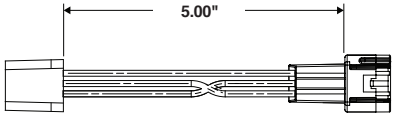
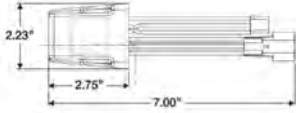

PLUGS

### PLUG, H4 CONNECTOR

	Part Number	Plug Side 2	Wire Length	Number of Wires	Wire Type	Warranty
	96630	H13 Connector	5in	3	SXL	1-Year
	96830	H13 Connector	4.5in	6	SXL	1-Year

PLUGS

### PLUG, H5 CONNECTOR



	Part Number	Plug Side 2	Wire Length	Number of Wires	Wire Type	Warranty
	95400	H4 Connector	4in	3	GPT	1-Year
	95846	3 Blade Terminal	5.5in	3	GPT	1-Year

PLUGS

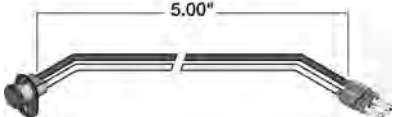

### PLUG, M/C SELF SEAL

	Part Number	Plug Side 2	Wire Length	Number of Wires	Wire Type	Warranty
	95410	.180 Bullet	5in	2	GPT	Lifetime

## PLUG, MALE PIN

	Part Number	Plug Side 2	Wire Length	Number of Wires	Wire Type	Warranty
	94865	Right Angle PL-3 Right Angle PL-3	10in	6	GPT	1-Year
	94897	Right Angle PL-3	5in	3	GPT	1-Year

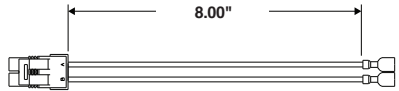

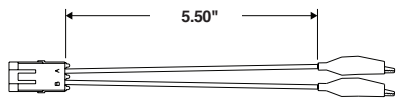

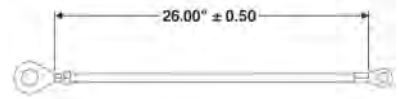

## PLUG, PACKARD CONNECTOR

	Part Number	Plug Side 2	Wire Length	Number of Wires	Wire Type	Warranty
	96256	Female Blade Terminal	8in	2	GPT	1-Year
	96254	Packard Connector 12010973	8in	2	GPT	1-Year
	96255	2 Alligator Clip	5.5in	2	GPT	1-Year

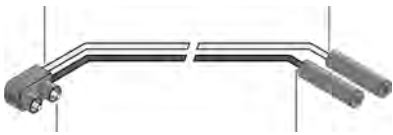
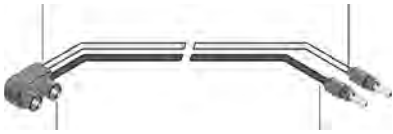
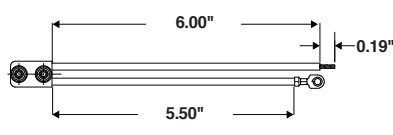
## PLUG, RING TERMINAL

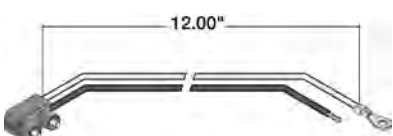
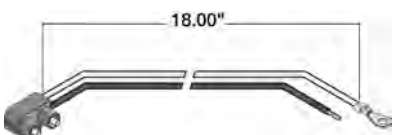
	Part Number	Plug Side 2	Wire Length	Number of Wires	Wire Type	Warranty
	96927	Ring Terminal	26in	1	GPT	1-Year

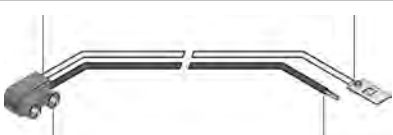
PLUG, PL-10

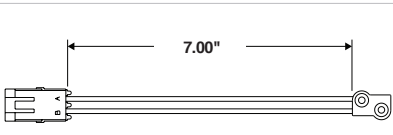
	Part Number	Plug Side 2	Wire Length	Number of Wires	Wire Type	Warranty
	94848	Female .156 Bullet	4.5in	2	GPT	1-Year
	94850	.156 Bullet	6.5in	2	GPT	1-Year
	94854	Stripped End Ring Terminal	6in	2	GPT	1-Year
	94902	Stripped End Ring Terminal	7in	2	GPT	1-Year
	94909	Stripped End Ring Terminal	12in	2	GPT	1-Year
	94916	Stripped End Ring Terminal	18in	2	GPT	1-Year
	94919	Stripped End Ring Terminal	6.5in	2	GPT	1-Year
	94920	Stripped End Ground Clip	6in	2	GPT	1-Year
	94972	.180 Bullet	6.5in	2	GPT	1-Year
	96249	Packard Connector 12010973	7in	2	GPT	1-Year





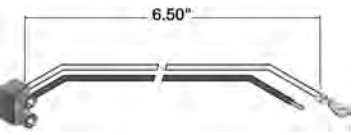
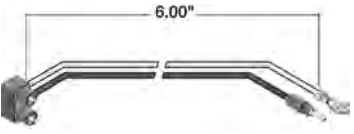



## PLUG, RIGHT ANGLE PL-10

	Part Number	Plug Side 2	Wire Length	Number of Wires	Wire Type	Warranty
	94924	Stripped End Ring Terminal	6.65in	2	GPT	1-Year
	94964	.156 Bullet Ring Terminal	6in	2	GPT	1-Year

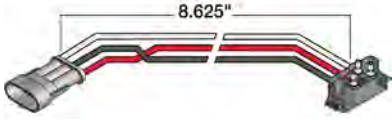
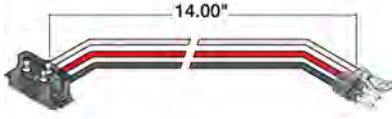
## PLUG, RIGHT ANGLE PL-2

	Part Number	Plug Side 2	Wire Length	Number of Wires	Wire Type	Warranty
	94837	Packard Connector 12020398	6.75in	2	SXL	1-Year
	94838	Packard Connector 12020398	6.75in	2	SXL	1-Year
	94851	Packard Connector 12020398	6.25in	2	SXL	1-Year
	94868	Packard Connector 1500027	8.5in	2	GPT	1-Year
	94991	Stripped End Ring Terminal	11in	2	GPT	1-Year
	94992	Stripped End Ring Terminal	11in	2	GPT	1-Year

# PLUG, RIGHT ANGLE PL-3

	Part Number	Plug Side 2	Wire Length	Number of Wires	Wire Type	Warranty
	94768	Fit 'N Forget S.S.	8.63in	3	GPT	Lifetime
	94802	.156 Bullet Ring Terminal	14in	3	GPT	1-Year
	94839	Packard Connector 12015793	22.25in	3	SXL	1-Year
	94840	Packard Connector 12015793	6.38in	3	SXL	1-Year
	94841	Packard Connector 12020398	6.75in	3	SXL	1-Year
	94882	.180 Bullet	14in	3	GPT	1-Year
	94931	Stripped End Ring Terminal	49in	3	GPT	1-Year
	94993	Stripped End Ring Terminal	11in	3	GPT	1-Year

## PLUG, WEATHER PACK

	Part Number	Plug Side 2	Wire Length	Number of Wires	Wire Type	Warranty
	80972	Packard Connector 12041307   Male Blade	5in			1-Year
	80974	Packard Connector 2965810   Packard Connector 2965809   Packard Connector 8917857	5in			1-Year
	80971	Packard Connector 12124580   Packard Connector 12077411   Packard Connector 12048369	10in			1-Year
	80973	Packard Connector 6288808   Packard Connector 12124580   Packard Connector 2965810	10.98in			1-Year
	80975	Packard Connector 12047955   Packard Connector 12047953   Pin Terminal	10in			1-Year
	80970	Packard Connector 12048369   Packard Connector 12124580	10in			1-Year

### PLUG, STRAIGHT PL-2

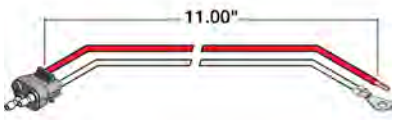
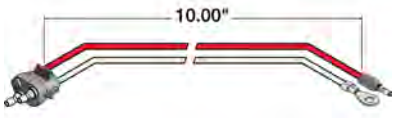
	Part Number	Plug Side 2	Wire Length	Number of Wires	Wire Type	Warranty
	94925	Stripped End   Ring Terminal	11in	2	GPT	1-Year
	94961	.156 Bullet   Ring Terminal	10in	2	GPT	1-Year

### PLUG, STRAIGHT PL-3

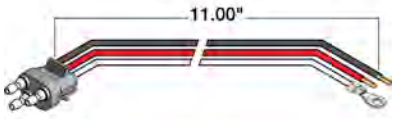
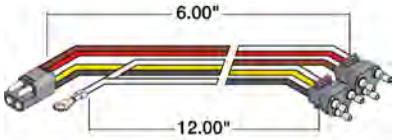
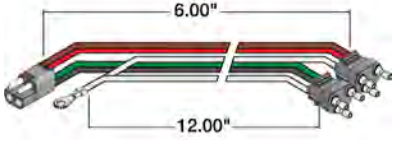
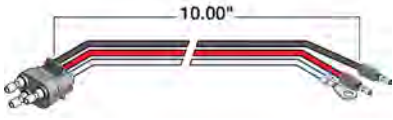
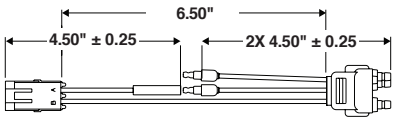
	Part Number	Plug Side 2	Wire Length	Number of Wires	Wire Type	Warranty
	94926	Stripped End   Ring Terminal	11in	3	GPT	1-Year
	94948	Ring Terminal   Molded Four Position .180	12in	6	GPT	1-Year
	94949	Ring Terminal   Molded Four Position .180	12in	6	GPT	1-Year
	94962	.156 Bullet   Ring Terminal	10in	3	GPT	1-Year
	96250	.180 Bullet   Female .180 Bullet   Packard Connector 12010973	6.5in	4	GPT	1-Year

## PLUG, STRAIGHT PL-3 | FIT 'N FORGET S.S.

PLUGS

	Part Number	Plug Side 2	Wire Length	Number of Wires	Wire Type	Warranty
	97344	Female .180 Bullet	10.63in	8	GPT	1-Year
	97366	Female .180 Bullet	11.5in	8	GPT	1-Year

## PLUG, SUPER 21 PLUG

PLUGS

	Part Number	Plug Side 2	Wire Length	Number of Wires	Wire Type	Warranty
	96930	Stripped End	12in	1	GPT	1-Year
	96932	.180 Bullet	5in	1	GPT	1-Year
	96934	.156 Bullet	5in	1	GPT	1-Year
	96936	Stripped End	48in	1	GPT	1-Year

# MARKER/CLEARANCE, FIT 'N FORGET

- Keeps water, salt and other corrosives from LED lamps
- Combine with LED lamps for Lifetime Lighting Warranty eligibility
- 16 gauge GPT wire
- Brass terminals
- For use with bumpers and skirts



	Part Number	Plug Side Two	Length	Center Distance	Number of Wires	Number of Plugs
<p>A=10.00" B=88.00"</p>	95460	Stripped End	88in	10in	2	5
<p>A=10.00" B=108.00"</p>	95461	Stripped End	108in	10in	2	7
<p>A=10.00" B=128.00"</p>	95462	Stripped End	128in	10in	2	9
<p>A=10.00" B=148.00"</p>	95463	Stripped End	148in	10in	2	11
<p>A=4.5" B=61.5"</p>	95464	Stripped End	61.5in	4.5in	2	4
<p>A=4.5" B=70.00"</p>	95465	Stripped End	70.5in	4.5in	2	6
<p>A=4.5" B=79.5"</p>	95466	Stripped End	79.5in	4.5in	2	8
<p>A=4.5" B=88.5"</p>	95467	Stripped End	88.5in	4.5in	2	10

STRINGS

MARKER/CLEARANCE

FIT 'N FORGET

# MARKER/CLEARANCE, PL-10

- For use with bumpers and skirts
- 16 gauge GPT wire
- Tin plated or brass terminals



	Part Number	Plug Side Two	Length	Number of Wires	Center Distance	Number of Plugs
	95450	Stripped End	88	2	10in	5
	95451	Stripped End	108	2	10in	7
	95452	Stripped End	128	2	10in	9
	95453	Stripped End	148	2	10in	11
	95454	Stripped End	60	2	4in	4
	95455	Stripped End	68	2	4in	6
	95456	Stripped End	76	2	4in	8
	95457	Stripped End	84	2	4in	10

### SOCKET, 1156 COMPATIBLE BULB

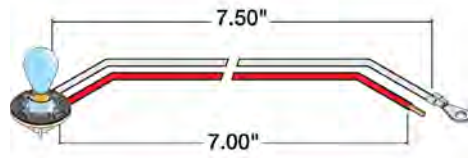

- 94937 - For use with Model 40 bulb replaceable lamps
- 16 gauge GPT wire; tin-plated brass terminals
- Bulb # 1156 included



Part Number	Plug Side 2	Length	Compatible Bulbs
94937	Stripped End / Ring Terminal	7.5in	1156

### SOCKET, 1157 COMPATIBLE BULB

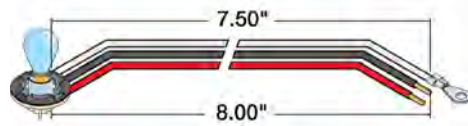

- 94938 - For use with Model 40 bulb replaceable lamps
- 16 gauge GPT wire
- Tin-plated brass terminals
- Bulb # 1157 included



Part Number	Plug Side 2	Length	Compatible Bulbs
94938	Stripped End / Ring Terminal	7.5in	1157

### SOCKET, 1157/1034 COMPATIBLE BULBS

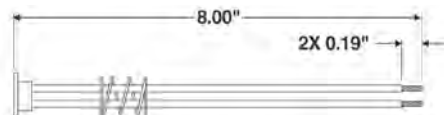

- With "in-line" guide pin for lamps with indexing, bayonet, candelabra type bases (e.g. nos. 1157\*, 1034\* bulbs)
- Supersedes part #9161



Part Number	Plug Side 2	Length	Compatible Bulbs	Light Type
9101	Stripped End	8in	1157 1034	S/T/T
9105	Stripped End	8in	1157 1034	Pedestal

### SOCKET, 194 COMPATIBLE BULB

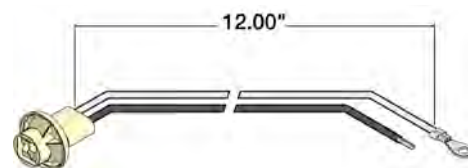

- For use with 18300R/Y and 25760 bulb replaceable lamps
- Bulb not included
- 18 gauge wires
- Available with black or white socket



Part Number	Plug Side 2	Length	Compatible Bulbs
94940	Stripped End / Ring Terminal	12in	194

SOCKET

1156 BULB

SOCKET

1157 BULB

SOCKET

1157/1034 BULBS

SOCKET

194 BULB



## SOCKET, 3157 COMPATIBLE BULB



- 94938 - For use with Model 40 bulb replaceable lamps
- 16 gauge GPT wire
- Tin-plated brass terminals
- Bulb #1157 included
- 95407 - For use with Model 60 and Model 91 bulb replaceable lamps
- 16 gauge GPT wire
- Tin-plated brass terminals
- Bulb #3157 included

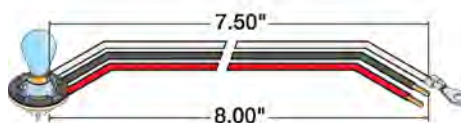

Part Number	Plug Side 2	Length	Compatible Bulbs
95407	Stripped End / Ring Terminal	9in	3157
95415	Stripped End / Ring Terminal	9in	3157
9467	Packard Connector 12010717	7in	3157

SOCKET

3157 BULBS

## SOCKET, 53/57/1895 COMPATIBLE BULBS



- For lamps with miniature bayonet type bases

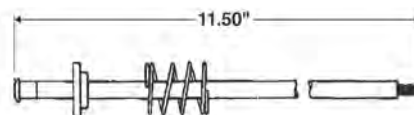

Part Number	Plug Side 2	Length	Compatible Bulbs
9103	Stripped End	11.5in	53 57 1895

SOCKET

53/57/1895 BULBS

## SOCKET, 67/1073/1156 COMPATIBLE BULBS



- For lamps with bayonet, candelabra type bases
- Supersedes part #9164

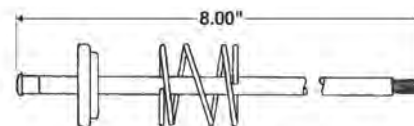

Part Number	Plug Side 2	Length	Compatible Bulbs	Light Type
9102	Stripped End	8in	67 1073 1156	Pedestal
9104	Stripped End	8in	67 1073 1156	Back-Up
9160	Stripped End	8in	67 1073 1156	Back-Up, Black Wire
9162	Stripped End	8in	67 1073 1156	Pedestal, Black Wire

SOCKET

67/1073/1156 BULBS

# 50 SERIES, 7 PIN, POLYCARBONATE

NOSE BOX

50 SERIES

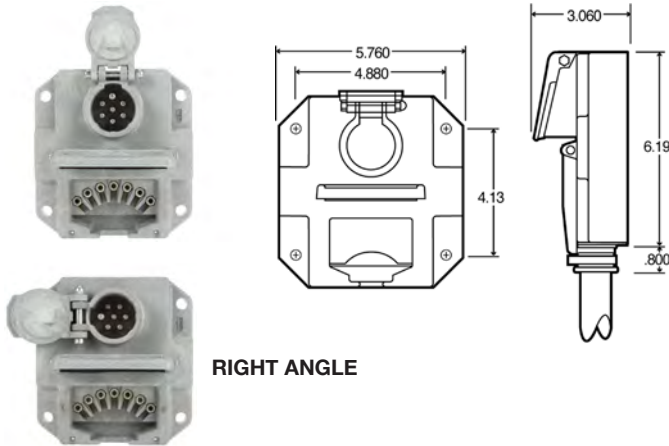

RIGHT ANGLE

- Easily installed on new trailers or as a retrofit on existing equipment
- Chemical-resistant and virtually indestructible box
- Internal electrical contacts sealed to eliminate corrosion
- 100% pre-test electrically with a 40 amp capacity
- Available with or without circuit breakers
- Color-coded trailer main cable hook up terminals for proper connections



Part Number	Housing Material	Housing Color	Number of Pins	Split/Solid Pin	Mount Type	Circuit Breaker	Angle
50805	PC	Gray	7	Solid Pin	Surface	No	Standard
50806	PC	Gray	7	Solid Pin	Surface	15 Amp	Standard
50822	PC	Gray	7	Solid Pin	Surface	No	Right Angle

# 50 SERIES, 7 PIN, PLASTIC

NOSE BOX

50 SERIES

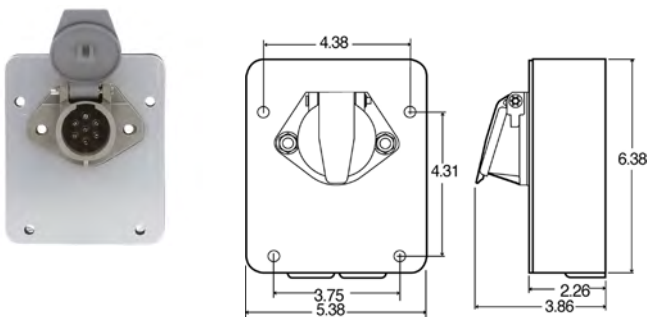

- Eliminates the need to rewire the nose box when replacing a damaged receptacle
- Fits standard mounting bolt pattern
- Includes 2 cable entry grommets
- Wiring remains stationary on studs inside the box
- No need to disturb wiring when replacing receptacle
- Receptacle simply plugs in and secures with 2 nuts
- Brass jumpers bridge from studs to receptacle pins



Part Number	Housing Material	Housing Color	Number of Pins	Split/Solid Pin	Mount Type	Angle	Circuit Breaker
50878	Plastic	Gray	7	Solid Pin	Surface	Standard	No
50879	Plastic	Gray	7	Split Pin	Surface	Standard	No

## GRAY SERVICE COVER, KIT



- Easy installation on all receptacles
- Includes Noryl cover, steel hinge pin, stainless steel spring, cotter pin and shaft retainer
- Not for use with #50805 style 7-ways

Part Number
50875



SERVICE COVER

## SMALL RECEPTACLE BOOT



- Protects electrical connections from moisture in flush mount applications
- Large boot fits all full-sized receptacles
- Small boots fits both 2 and 3 bolt flange receptacles with end or bottom access

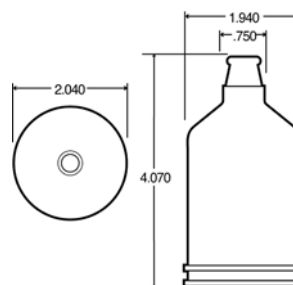

Part Number
50890

RECEPTACLE BOOT

## LARGE RECEPTACLE BOOT



- Protects electrical connections from moisture in flush mount applications
- Large boot fits all full-sized receptacles
- Small boots fits both 2 and 3 bolt flange receptacles with end or bottom access

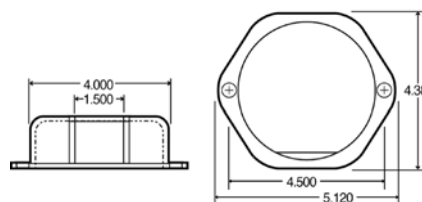

Part Number
50892

RECEPTACLE BOOT

## ANCHOR TEE



- Ensures that the full capacity of the shared blue circuit is available to the ABS when vehicle is moving
- Ensures that accessory leads are turned off
- Two 12 gauge 24" wires

Part Number
50895



ANCHOR TEE

## SPLIT PIN



- Eliminates the need to rewire the nose box when replacing a damaged receptacle

Part Number
50898



SPLIT PIN

ADAPTOR BOX

## SURFACE MOUNT ADAPTOR BOX

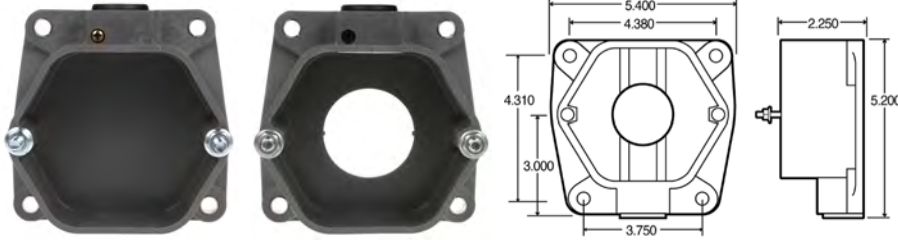

**BOTTOM ACCESS      REAR ACCESS**

- Features molded, threaded brass inserts for receptacle mounting
- Bottom entry for standard wiring with strain relief mechanism
- Available with back access hole to accommodate rear entry applications



Part Number	Access	Mount Type
50882	Bottom	Surface
50883	Rear	Surface

CABLE GROMMET

## CABLE GROMMET



Part Number
50807



CAP LATCH REPAIR KIT

## CAP LATCH REPAIR KIT



Part Number
50808



RECTANGULAR COVER

## GRAY RECTANGULAR COVER, KIT



Part Number
50809



### 50 SERIES, SPLIT PIN, FLUSH MOUNT, 4 PIN

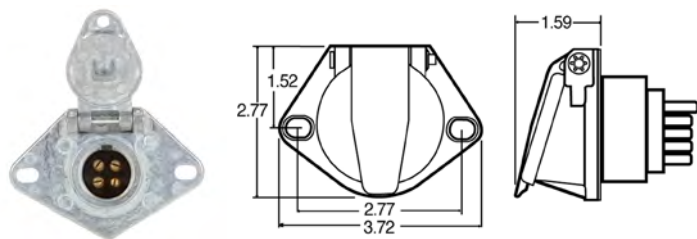

- Available in 7-way, 6-way, and 4-way variations
- Compact socket design with exposed terminals for easy installation in modern trailers
- Extended interior plug prevents damage to shell
- Integral finger grips for positive pull



Part Number	Housing Material	Housing Color	Number of Pins
50886	Steel	Silver	4

SPLIT PIN

FLUSH MOUNT

### 50 SERIES, SPLIT PIN, FLUSH MOUNT, 6 PIN

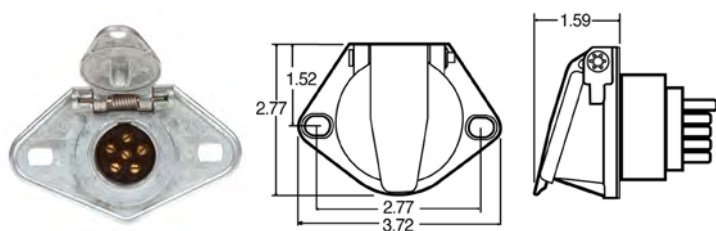

- Available in 7-way, 6-way, and 4-way variations
- Compact socket design with exposed terminals for easy installation in modern trailers
- Extended interior plug prevents damage to shell
- Integral finger grips for positive pull



Part Number	Housing Material	Housing Color	Number of Pins
50888	Steel	Silver	6

SPLIT PIN

FLUSH MOUNT

### 50 SERIES, SPLIT PIN, FLUSH MOUNT, 7 PIN, PLASTIC

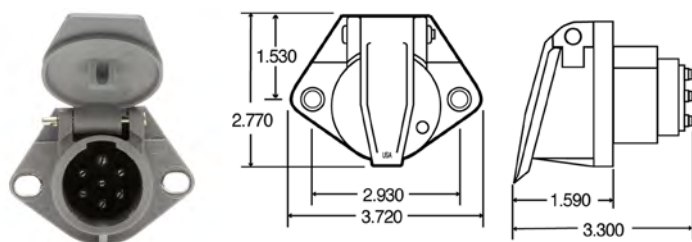

- Tough GE Noryl, non-conductive, corrosion resistant body
- Floating type, cadmium-plated brass pins allow best alignment and long-lasting contact with plug
- Internal connections feature a direct wired ground
- Circuits are identified by color codes and embossed notations
- Ring terminals are used to connect wires
- Receptacle pins prevent increased resistance due to strand breakage caused by set screws
- Available in standard and circuit breaker version
- Meets SAE J560 standards
- Push-on-terminal design, #50872 compatible as OEM replacement
- We recommend using rubber boots when flush mounting receptacles



Part Number	Housing Material	Housing Color	Number of Pins	More Info
50869	Plastic	Gray	7	
50872	Plastic	Gray	7	Push-On

SPLIT PIN

FLUSH MOUNT

## 50 SERIES, SPLIT PIN, FLUSH MOUNT, 7 PIN, STEEL

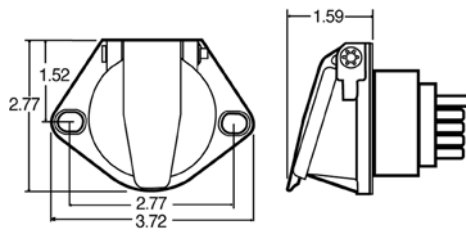

- Available in 7-way, 6-way, and 4-way variations
- Compact socket design with exposed terminals for easy installation in modern trailers
- Extended interior plug prevents damage to shell
- Integral finger grips for positive pull



Part Number	Housing Material	Housing Color	Number of Pins
50896	Steel	Silver	7

## 50 SERIES, SPLIT PIN, SURFACE MOUNT, 7 PIN

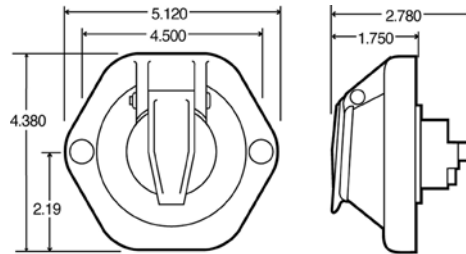

- Tough GE Noryl, non-conductive, corrosion resistant body
- Floating type, cadmium-plated brass pins allow best alignment and long-lasting contact with plug
- Internal connections feature a direct wired ground
- Circuits are identified by color codes and embossed notations
- Ring terminals are used to connect wires
- Receptacle pins prevent increased resistance due to strand breakage caused by set screws
- Available in standard and circuit breaker version
- Meets SAE J560 standards
- We recommend using rubber boots with flush mount receptacles



Part Number	Housing Material	Housing Color	Number of Pins	More Info
50861	Plastic	Gray	7	
50863	Plastic	Gray	7	15 Amps
50865	Plastic	Gray	7	20 Amps
50867	Plastic	Gray	7	Threaded Stacking Studs

SPLIT PIN

FLUSH MOUNT

SPLIT PIN

SURFACE MOUNT

## 50 SERIES, SOLID PIN, FLUSH MOUNT, 7 PIN



- Tough GE Noryl, non-conductive, corrosion resistant body
- Floating type, cadmium-plated brass pins allow best alignment and long-lasting contact with plug
- Internal connections feature a direct wired ground
- Circuits are identified by color codes and embossed notations
- Ring terminals are used to connect wires
- Receptacle pins prevent increased resistance due to strand breakage caused by set screws
- Available in standard and circuit breaker version
- Meets SAE J560 standards
- Push-on-terminal design, #50872 compatible as OEM replacement
- We recommend using rubber boots when flush mounting receptacles

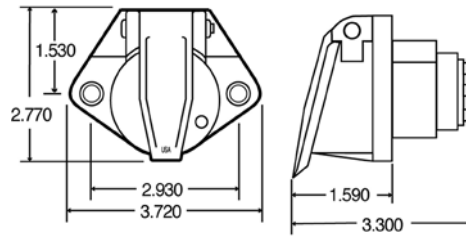

SOLID PIN

FLUSH MOUNT

Part Number	Housing Material	Housing Color	Number of Pins
50868	Plastic	Gray	7

## 50 SERIES, SOLID PIN, SURFACE MOUNT, 7 PIN



- Tough GE Noryl, non-conductive, corrosion resistant body
- Floating type, cadmium-plated brass pins allow best alignment and long-lasting contact with plug
- Internal connections feature a direct wired ground
- Circuits are identified by color codes and embossed notations
- Ring terminals are used to connect wires
- Receptacle pins prevent increased resistance due to strand breakage caused by set screws
- Available in standard and circuit breaker version
- Meets SAE J560 standards
- We recommend using rubber boots with flush mount receptacles

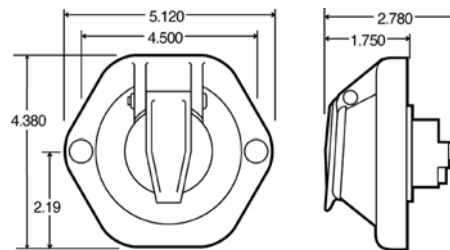

SOLID PIN

SURFACE MOUNT

Part Number	Housing Material	Housing Color	Number of Pins	More Info
50860	Plastic	Gray	7	
50866	Plastic	Gray	7	Threaded Stacking Studs

## TRAILER CORD, 7 CONDUCTOR, METAL



- Meets ATA, SAE and TMC requirements
- Designed for use in wide temperature range (-87°F to 195°F)
- Available in 12 and 15 foot lengths
- Meets or exceeds SAE J559 or J1067 as applicable
- 100% pre-tested



Part Number	Length	Plug Side 1	Plug Side 2	Wire Gauge
97151	144	Female 7 Pole Plug	Female 7 Pole Plug	10 16
97153	180	Female 7 Pole Plug	Female 7 Pole Plug	10 16

## TRAILER CORD, 7 CONDUCTOR, NYLON



- Ideal for supplying power to trailer and dolly ABS systems
- Designed for use in wide temperature range (-87°F to 195°F)
- Available in 12 and 15 foot lengths
- Meets TMC recommendations (RP137) and SAE J2222
- 100% pre-tested







Part Number	Length	Plug Side 1	Plug Side 2	Wire Gauge
97160	144	Female 7 Pole Plug	Female 7 Pole Plug	8 10 12
97161	180	Female 7 Pole Plug	Female 7 Pole Plug	10 8 12



## TRAILER CONNECTOR CABLE REPLACEMENT PLUGS

- Features brass terminals and rear moisture seal
- Unique 360° cable clamp that helps prevent the cable from being accidentally pulled out
- Resistant to degreasers, solvents and contact cleaners
- Features zinc die-cast housing and brass terminals
- Nylon insert is resistant to petro-chemicals



	Part Number	Conductors	Plug Side 1	Housing Material
	50885	4	Female 4 Pole Plug	Steel
	50887	6	Female 6 Pole Plug	Steel
	97158	7	Female 7 Pole Plug	Plastic
	97159	7	Female 7 Pole Plug	Steel

JUNCTION BOXES

SUPER 50

## SUPER 50, FLUSH MOUNT, ROUND



- Made of high-impact, chemical-resistant plastic
- Mounted by four holes on 5-1/2" diameter circle
- Contains 8 pre-tapped holes to accept compression fittings or filler plugs
- 50801 requires a 4-7/8" clearance hole



Part Number	Housing Material	Number of Ports	Terminal Connections
50800	Plastic	8	0

JUNCTION BOXES

SUPER 50

## SUPER 50, BUCKPLATE MOUNT, ROUND



50401

50801

- Made of high-impact, chemical-resistant plastic
- Mounted by four holes on 5-1/2" diameter circle
- Contains 8 pre-tapped holes to accept compression fittings or filler plugs
- 50801 requires a 4-7/8" clearance hole



Part Number	Housing Material	Number of Ports	Terminal Connections
50401	Plastic	8	8
50801	Plastic	8	0

JUNCTION BOXES

SUPER 50

## SUPER 50, BUCKPLATE MOUNT, ROUND, KIT



- 50400/50060 - Contains 50800 junction box, 50816/50812 junction box cap, 50820 terminal block, four 50830 filler plugs and mounting and assembly screws



Part Number	Housing Color	Housing Material	Number of Ports	Terminal Connections	Kit Includes/ Replacement Parts
50400	Gray	Plastic	8	8	50800 junction box, 50816 junction box cap, 50850 terminal block

## SUPER 50, BUCKPLATE MOUNT, RECTANGULAR



- With 50% more harness ports, alleviates the need for multiple boxes, while allowing for the addition of more harness systems and increased lighting needs
- Larger box makes it easier to work on internal connections
- Clear lid offers easy viewing of connections without having to remove lid, saving time when trying to identify lighting system problems
- Made of high-impact, chemical-resistant, approved insulating plastic providing a long service life and eliminating the time and money needed for repair and replacement
- Mounted by four eyelet-reinforced holes in base of box for increased durability
- Contains 12 pre-tapped holes to accept compression fittings or filler plugs allowing for greater configuration versatility
- Uses 50 Series compression fittings or 50830 filler plugs (6 included in kit)

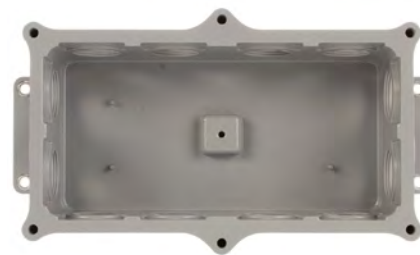

Part Number	Housing Color	Housing Material	Number of Ports	Terminal Connections
50601	Gray	Plastic	12	0

JUNCTION BOXES

SUPER 50

## SUPER 50, BUCKPLATE MOUNT, RECTANGULAR, KIT



- With 50% more harness ports, alleviates the need for multiple boxes, while allowing for the addition of more harness systems and increased lighting needs
- Larger box makes it easier to work on internal connections
- Clear lid offers easy viewing of connections without having to remove lid, saving time when trying to identify lighting system problems
- Dual "Dog bone" ground strap feature allows 4 terminals to be common, replacing the need for multiple junction boxes, offering additional cost savings
- Silicone gasket on lid helps to eliminate damage from moisture and corrosives within the box, reducing costly repairs
- Made of high-impact, chemical resistant, approved insulating plastic providing a long service life and eliminating the time and money needed for repair and replacement
- Mounted by four eyelet-reinforced holes in base of box for increased durability
- Contains 12 pre-tapped holes to accept compression fittings or filler plugs allowing for greater configuration versatility
- Uses 50 Series compression fittings or 50830 filler plugs (6 included in kit)



Part Number	Housing Color	Housing Material	Number of Ports	Terminal Connections	Kit Includes/ Replacement Parts
50600	Gray Clear	Plastic	12	16	50800 junction box, 50816 junction box cap, 50850 terminal block

JUNCTION BOXES

SUPER 50

## TRUCK-LITE, BUCKPLATE MOUNT, RECTANGULAR



- Provides a secure connection to consumer trailers through a stripped wire connection or a stripped wire connection with a standard 4-pin flat molded connector
- Sealed connector to the main power harness in the truck
- Adhesive-lined heat shrinks protect the main harness connection to the box
- Quick connect box can be easily replaced if necessary
- The hinge pin has been designed to fit tightly into the hinge, keeping the lid on the box and reduces the chance for water to get into the connection terminals
- The black color of the box will allow it to blend into the rear bumper mounting location
- Easily adaptable for trailers, box trucks, retail vehicles, and box vans with a hitch set-up
- Mounting holes are in the same locations the current Phillips boxes
- 1/4" bolt used to mount the box



Part Number	Housing Color	Housing Material	Number of Ports	Terminal Connections
96511	Black	Nylon	1	4
96512	Black	Nylon	1	5

## SIGNAL-STAT, BUCKPLATE MOUNT, RECTANGULAR



- Seven #10-32 studs
- Scientifically engineered supporting ribs for extra strong construction
- Non-corrosive
- Mounting: Two holes on 7.69" centers
- Size: 8-1/2"L X 3-1/4"W X 2-1/8"H



Part Number	Housing Color	Housing Material	Number of Ports	Terminal Connections
3121	Black	Plastic	7	7

## 50 SERIES, FILLER PLUG

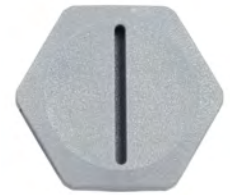

50 SERIES

FILLER PLUG

Part Number	Housing Color
50830	Gray

## 50 SERIES, JAM NUT



- Use for installation of 3-part compression fittings in areas other than in the junction boxes
- 1-1/8" clearance hole required



50 SERIES

JAM NUT

Part Number	Housing Color
50845	Gray

## 50 SERIES, JUNCTION BOX HARDWARE, KIT



50 SERIES

HARDWARE KIT

Part Number
50602

RING TERMINAL / GASKET

### RING TERMINAL



- Non-Insulated terminals for use with "50 series" harnesses and junction boxes
- 25 per bag
- For 14-16 gauge wire only



Part Number
97912

### TERMINAL



- Non-Insulated terminals for use with "50 series" harnesses and junction boxes
- 25 per bag
- For 14-16 gauge wire only



Part Number
97929

50 SERIES

GROUND STRAP

### 50 SERIES, GROUND STRAP



Part Number	Housing Color
50608	Brass

### 50 SERIES, DUAL GROUND STRAP



Part Number	Housing Color
50609	Brass

50 SERIES

CAP

### 50 SERIES, JUNCTION BOX CAP



Part Number	Housing Color
50816	Gray
50812	Clear

## 50 SERIES, JUNCTION BOX LID



- Silicone gasket on lid helps eliminate damage from moisture and corrosives
- High-impact, chemical resistant, approved insulated plastic provides long life, eliminates time & money for repair & replacement
- Replacement lid, gasket & screws

Part Number	Housing Material	Housing Color
50606	PC	Clear
50832	ABS	Clear

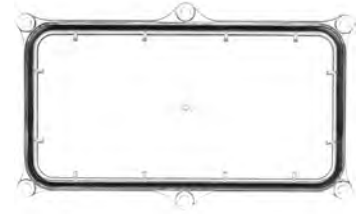

50 SERIES

JUNCTION BOX LID

## 50 SERIES, REPLACEMENT LID GASKET



- Clear lid offers easy viewing of connections without having to remove lid, saving time when trying to identify lighting system problems
- Silicone gasket on lid helps to eliminate damage from moisture and corrosives within the box, reducing costly repairs.

Part Number	Housing Color
50607	Clear



50 SERIES

REPLACEMENT LID GASKET

## 50 SERIES, TERMINAL BLOCK



- 50850 - Kit contains 50820 terminal block, four 50830 filler plugs, assembly and mounting screws.
- Made of approved insulating plastic
- Contains 8 color coded terminal posts
- 50401 - Contains 50801 junction box, 50816 junction box cap, 50820 terminal block, four 50830 filler plugs and mounting and assembly screws

Part Number	Housing Color	Kit
50820	Black	No
50850	Black	Yes



50850



50820

50 SERIES

TERMINAL BLOCK

### 1 CONDUCTOR, COMPRESSION FITTING, PVC, 0.215"



Part Number	# of Cables Per Fitting	Material Color
97913	5	Gray

- 3-part fitting consisting of a pre-tapped cap, threaded base and black PVC grommet that is available with 6 different hole sizes to accommodate various conductor cables



1 CONDUCTOR

### 2 CONDUCTOR, COMPRESSION FITTING, DIE CAST, 0.375 "



Part Number	# of Cables Per Fitting	Material Color
97003	1	Silver

- For increased water resistance, an optional 3/8" ID water tight compression fitting is available and will accommodate a 2 conductor round cable.
- UL and CSA approved.



2 CONDUCTOR

### 2 CONDUCTOR, COMPRESSION FITTING, PVC, 0.375"



Part Number	# of Cables Per Fitting	Material Color
50840	1	Gray

- 3-part fitting consisting of a pre-tapped cap, threaded base and black PVC grommet that is available with 6 different hole sizes to accommodate various conductor cables



2 CONDUCTOR

### 2 CONDUCTOR, FLAT CABLE FITTING, PVC, 0.31" X 0.19"



Part Number	# of Cables Per Fitting	Material Color
50848	1	Gray

- 3-part fitting consisting of a pre-tapped cap, threaded base and black PVC grommet that is available with 6 different hole sizes to accommodate various conductor cables



2 CONDUCTOR

### 3 CONDUCTOR, COMPRESSION FITTING, PVC, 0.45" X 0.19"



Part Number	# of Cables Per Fitting	Material Color
50846	1	Gray

- 3-part fitting consisting of a pre-tapped cap, threaded base and black PVC grommet that is available with 6 different hole sizes to accommodate various conductor cables



3 CONDUCTOR

### 4 CONDUCTOR, COMPRESSION FITTING, PVC, 0.45" X 0.21"



Part Number	# of Cables Per Fitting	Material Color
50847	1	Gray

- 3-part fitting consisting of a pre-tapped cap, threaded base and black PVC grommet that is available with 6 different hole sizes to accommodate various conductor cables



4 CONDUCTOR



### 4 TO 5 CONDUCTOR, COMPRESSION FITTING, PVC, 0.485"



- 3-part fitting consisting of a pre-tapped cap, threaded base and black PVC grommet that is available with 6 different hole sizes to accommodate various conductor cables

Part Number	# of Cables Per Fitting	Material Color
50841	1	Gray



4-5 CONDUCTOR

### 6 TO 7 CONDUCTOR, COMPRESSION FITTING, PVC, 0.709"



- 3-part fitting consisting of a pre-tapped cap, threaded base and black PVC grommet that is available with 6 different hole sizes to accommodate various conductor cables

Part Number	# of Cables Per Fitting	Material Color
50842	1	Gray



6-7 CONDUCTOR

### RIGHT ANGLE HARNESS CLIP, SILVER STEEL, 1.25"



- Steel clips
- Supplied with all multi-plug S/T/T harness

Part Number	Material Color
97011	Silver



HARNESS CLIP

### STRAIGHT MOLD HARNESS CLIP, SILVER STEEL, 1.5"



- Steel clips
- Supplied with all multi-plug S/T/T harness

Part Number	Material Color
97913	Silver



HARNESS CLIP

10-12 GAUGE

## HEAT SHRINK TUBING, 10-12 GAUGE



• Custom length available in 12" increments



Part Number	Part	Part
97956	10	12

14-16 GAUGE

## HEAT SHRINK TUBING, 14-16 GAUGE

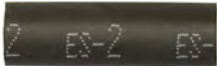

Part Number	Part	Part
97955	14	16

10-12 GAUGE

## WIRE SPLICES, 10-12 GAUGE

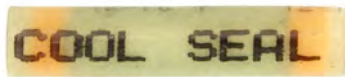

Part Number
97389

14-16 GAUGE

## WIRE SPLICES, 14-16 GAUGE



Part Number
97390

18-22 GAUGE

## WIRE SPLICES, 18-22 GAUGE



Part Number
97391

## FUSES, 20A



- Ready to install, 6 or 12 volt
- Engineered for greater ease of use
- Circuit may be examined without removal of fuse
- 6" 16 gauge looped wire
- Nylon housing assures greater durability
- Use to protect radios, fog lights, etc.
- Fuse snaps into place



Part Number	Volts	Housing Material	Housing Material
9414BL	12	Black	Nylon

20 A FUSES

## FUSES, 30A



- Ready to install, 6 or 12 volt
- Engineered for greater ease of use, fuse snaps into place
- Circuit may be examined without removal of fuse
- 6" 16 gauge looped wire
- Nylon housing assures greater durability
- Use to protect radios, fog lights, etc.



Part Number	Volts	Housing Material	Housing Material
9415BL	12	Black	Nylon

30 A FUSES

## FUSES, 30A, DISPLAY



- Ready to install, 6 or 12 volt
- Engineered for greater ease of use, fuse snaps into place
- Circuit may be examined without removal of fuse
- 6" 16 gauge looped wire
- Nylon housing assures greater durability
- Use to protect radios, fog lights, etc.



Part Number	Volts	Housing Material	Housing Material
9410BL	12	Black	Nylon

30 A FUSES

# MIRRORS

**COMBINATION MIRRORS**

**Page 453**

**WEST COAST MIRRORS**

**Pages 454-461**

**FLAT MIRRORS**

**Pages 462-469**

**CONVEX MIRRORS**

**Pages 470-476**

**MIRROR BRACKETS & ACCESSORIES**

**Pages 478-483**

# Looking for even more product information?

Visit [truck-lite.com](http://truck-lite.com)



**Powerful Search**



**360° Product Images**



**Easy-To-Find Replacement Parts**

## COMBINATION MIRROR, 9"X 17", RECTANGULAR

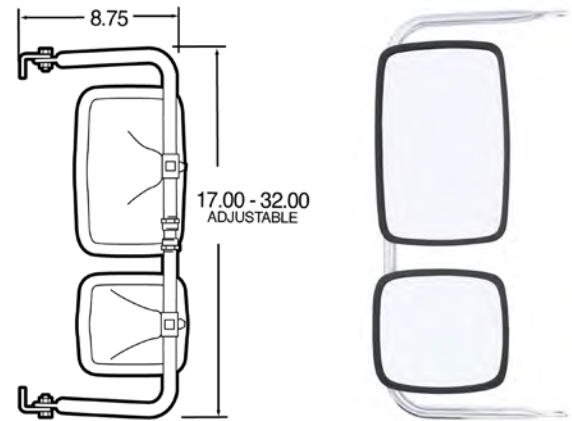

- Replacement heads for Grumman Olson, Union City Body and Utilimaster vehicles
- Silvered mirror glass resists pitting, peeling and corrosion
- Glass is mounted in vinyl gasket
- Features a brushed stainless steel finish
- Flexible, adjustable bracket expands from 17"-32" to fit most vehicles and offset mounting points
- Popular for use on step van and package delivery vans
- Assembly includes two mirrors-6-1/2"x10" flat glass head and 6-1/2"x6" convex glass head
- Fits to either side of the vehicle
- Mounting hardware and bracket also included
- Replaces Signal-Stat 7580/7581

Part Number	Housing Color	Housing Material	Mounting Bracket	Replacement Parts
97846	Silver	Steel	Yoke	97847 flat mirror, 97674 flat mirror, 97848 convex mirror
97668	Black	Steel	Yoke	97672 flat mirror, 97675 flat mirror, 97670 convex mirror, 97733 head clamp
97669	White	Steel	Yoke	97673 flat mirror, 97676 flat mirror, 97671 convex mirror

6 IN X 11 IN

### 6"X 11"

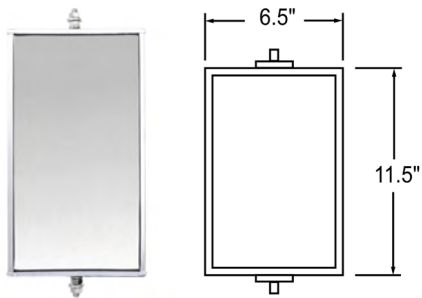

- Super Jr. West Coast
- 5/16" stud diameter, center rod
- Replaces Signal-Stat 7020



Part Number	Housing Color	Housing Material	Mounting Bracket
97652	Silver	Aluminum	West Coast Rigid Bracket
97643	Silver	Stainless Steel	West Coast Rigid Bracket

6 IN X 11 IN

### 6"X 11", KIT

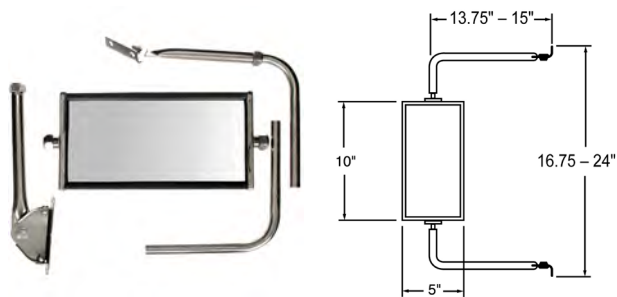

- Stainless steel mirror head
- Arms: 16-3/4" -24" vertical, stainless steel finish, 13-3/4" -15" horizontal, stainless steel finish
- Ideal for most pick-up trucks, small stake trucks and campers
- 7/8" hex compression nut fits heavy duty 3/4" tubing
- Replaces Signal-Stat 7547



Part Number	Housing Color	Housing Material	Mounting Bracket	Kit Includes
97644	Silver	Stainless Steel	West Coast Rigid Bracket	97643 mirror

6 IN X 16 IN

### 6"X 16"

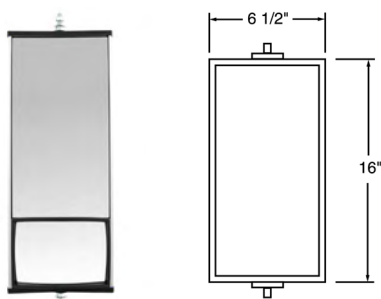

- 5/16" stud diameter, center rod
- Convex mirror on lower portion allows wide angle view without separate mirror
- Replaces Signal-Stat 7002



Part Number	Housing Color	Housing Material	Mounting Bracket
97632	Silver	Aluminum	West Coast Rigid Bracket



### 6"X 16"



- Replacement head for 97633
- Tube-through style mount
- Convex mirror on lower portion allows wide angle view without separate mirror
- Replaces Signal-Stat 7095

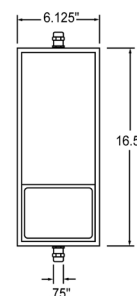

6 IN X 16 IN

Part Number	Housing Color	Housing Material	Mounting Bracket
97634	Silver	430 Bright Stainless Steel	West Coast Rigid Bracket

### 6"X 16"



- Rod through construction
- Steel end caps for strength
- 5/16" stud diameter with center rod
- Durable, economical replacement heads
- Electrostatic-applied paint provides additional corrosion protection
- Full vinyl gasket insulated mirror glass
- Heater keeps glass free from icing and fogging
- Replaces Signal-Stat 7001/7005/7006/7010

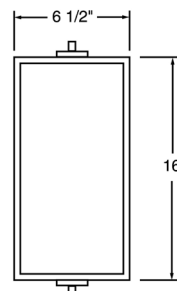

6 IN X 16 IN

Part Number	Housing Color	Housing Material	Mounting Bracket
97628	White	Aluminum	West Coast Rigid Bracket
97627	Silver	Aluminum	West Coast Rigid Bracket
97629	Black	Aluminum	West Coast Rigid Bracket

### 6"X 16"



- Silvered mirror glass resists pitting, peeling and corrosion
- Glass is cushioned in a vinyl gasket
- Designed as a rod-through style head with a 5/16"-18 threaded rod
- Wider end caps provide better support than imported plastic end cap mirrors
- Heater keeps glass free from icing and fogging

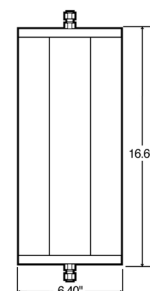

6 IN X 16 IN

Part Number	Housing Color	Housing Material	Mounting Bracket
97812	Silver	Stainless Steel	West Coast Rigid Bracket
97860	Silver	Aluminum	West Coast Rigid Bracket

## 6"X 16", HEATED

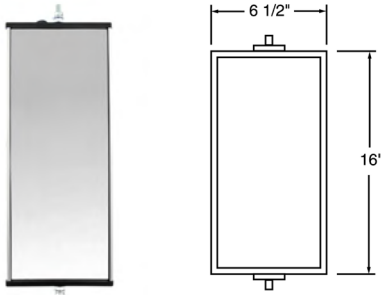

- Rod-through construction
- Steel end caps for strength
- 5/16" stud diameter with center rod
- Durable, economical replacement heads
- Electrostatic applied paint provides additional corrosion protection
- Full vinyl gasket insulated mirror glass
- Heater keeps glass free from icing and fogging
- Replaces Signal-Stat 7001/7005/7006/7010



Part Number	Housing Color	Housing Material	Mounting Bracket	Plug Side 2
97630	Silver	Aluminum	West Coast Rigid Bracket	Stripped End

## 6"X 16", HEATED &amp; LIGHTED

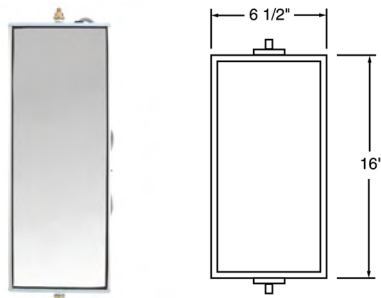

- Rod-through construction
- Steel end caps for strength
- 5/16" stud diameter with center rod
- Durable, economical replacement heads
- Electrostatic applied paint provides additional corrosion protection
- Full vinyl gasket insulated mirror glass
- Heater keeps glass free from icing and fogging
- Replaces Signal-Stat 7001/7005/7006/7010



Part Number	Housing Color	Housing Material	Mounting Bracket	Plug Side 2
97631	Silver	Aluminum	West Coast Rigid Bracket	Stripped End

## 6"X 16", KIT

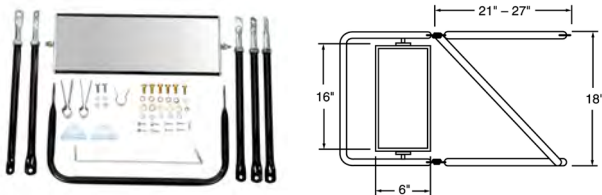

- Extends 18 -23" as needed
- Includes all hardware for easy assembly
- Swing away yoke helps prevent damage
- Fits all conventional style trucks
- Mirror glass mounted in ozone-resistant vinyl to isolate against road shock and vibration
- Replaces Signal-Stat 7513



Part Number	Housing Color	Housing Material	Mounting Bracket	Kit Includes
97694	Black	Steel	Yoke	97629 mirror, 97726 bracket

## 6"X 16", KIT



- Arms: 25"-40" vertical, stainless steel finish 5" horizontal, stainless steel finish
- Fits any straight-sided vehicles and some tilt cabs
- Convex mirror on lower portion allows wide angle view without separate mirror
- 7/8" hex compression nut fits heavy duty 3/4" tubing
- Replaces Signal-Stat 7514

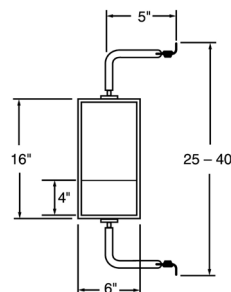

Part Number	Housing Color	Housing Material	Mounting Bracket	Kit Includes
97633	Silver	430 Bright Stainless Steel	West Coast Rigid Bracket	97634 mirror

6 IN X 16 IN

## 7"X 16"



- Arms: 18" vertical span, 15"-20" horizontal adjustment
- Swing away yoke
- Fits most conventional style trucks
- Includes all hardware for easy assembly
- Replaces Signal-Stat 7515

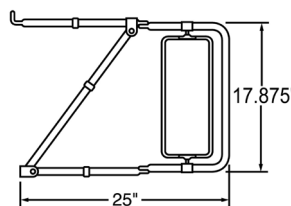

Part Number	Housing Color	Housing Material	Mounting Bracket	Replacement Parts
97693	Silver	Stainless Steel	Yoke	97822 mirror, 97725 bracket

7 IN X 16 IN

## 7"X 16"



- Convex mirror on lower portion provides wide angle view
- 5/16-8" mounting stud
- Replaces Signal-Stat 7086

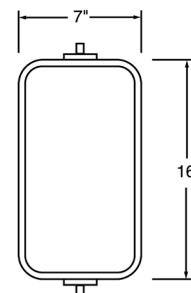

Part Number	Housing Color	Housing Material	Mounting Bracket
97635	Silver	Stainless Steel	West Coast Rigid Bracket

7 IN X 16 IN

7 IN X 16 IN

7"X 16"

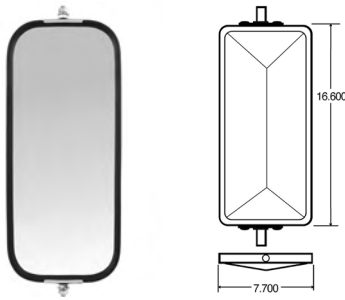

- Ford, Chevy/GMC and other truck replacement heads
- Silvered mirror glass resists pitting, peeling and corrosion
- Glass is cushioned in a vinyl ozone-resistant gasket
- Fits most standard OEM west coast brackets
- Mounts on two 5/16"-18 bolts
- Includes west coast bracket and adapters for International Trucks
- Replaces Signal-Stat 7800/7801/7803/7804/7810/7814



Part Number	Housing Color	Housing Material	Mounting Bracket	Plug Side 2
97637	White	Stainless Steel	West Coast Rigid Bracket	Stripped End
97861	Silver	Stainless Steel	West Coast Rigid Bracket	Stripped End
97636	Black	Stainless Steel	West Coast Rigid Bracket	Stripped End

7 IN X 16 IN

7"X 16"

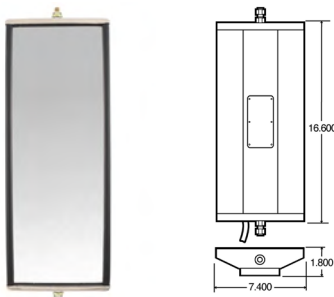

- Freightliner/Sterling style replacement
- Silvered mirror glass resists pitting, peeling and corrosion
- Glass is cushioned in a vinyl ozone-resistant gasket
- Designed as a rod-through style head with a 5/16"-18 threaded rod
- Heated version has a field-replaceable PTC heating element that provides continuous heat even in sub-zero temperatures
- Bright stainless steel, painted steel or economical aluminum finishes
- Fits most standard OEM west coast brackets and mounts on two 5/16"-18 bolts
- Replaces Signal-Stat 7815-7819 series



Part Number	Housing Color	Housing Material	Mounting Bracket
97836	Silver	Stainless Steel	West Coast Rigid Bracket
97839	Silver	Aluminum	West Coast Rigid Bracket

7 IN X 16 IN

7"X 16"

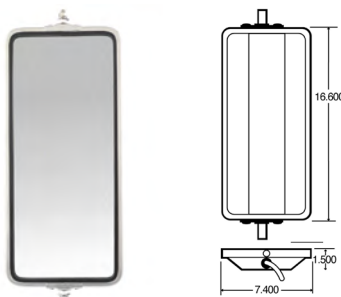

- Full 1/4" glass is cushioned with a vinyl gasket and meets OEM requirements
- Features a bright stainless steel finish
- Field replaceable PTC heating element that provides continuous heat even in sub-zero temperatures
- Direct replacement for many OEM mirrors
- Replaces Signal-Stat 7084/7085 series



Part Number	Housing Color	Housing Material	More Info
97809	Silver	Stainless Steel	
97822	Silver	Stainless Steel	OEM Style

## 7"X 16"



- OEM replacement for International S-series and other trucks
- Full vinyl gasket insulated glass
- Heated mirrors feature International "bullet style" door plug

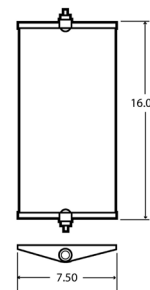

7 IN X 16 IN

Part Number	Housing Color	Housing Material	Mounting Bracket
97624	Silver	Aluminum	West Coast Rigid Bracket

## 7"X 16"



- Silvered mirror glass resists pitting, peeling and corrosion
- Glass is cushioned in a vinyl ozone-resistant gasket
- Fits most standard OEM brackets with T-bolt mount
- Designed with a single-piece mirror back
- Bubble back and rib back designs are popular for use on construction and delivery trucks
- Replaces Signal-Stat 7081, 7082, 7083 and 7093

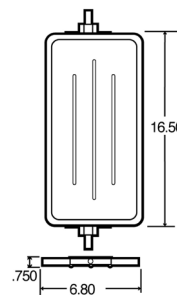

7 IN X 16 IN

Part Number	Housing Color	Housing Material	Mounting Bracket	More Info
97806	White	Steel	West Coast Rigid Bracket	Rib Back
97808	White	Steel	West Coast Rigid Bracket	Bubble Back
97811	Black	Steel	West Coast Rigid Bracket	Rib Back

## 7"X 16", HEATED



- Ford, Chevy/GMC and other truck replacement heads
- Silvered mirror glass resists pitting, peeling and corrosion
- Glass is cushioned in a vinyl ozone-resistant gasket
- Fits most standard OEM west coast brackets
- Mounts on two 5/16"-18 bolts
- Includes west coast bracket and adapters for International Trucks
- Replaces Signal-Stat 7800/7801/7803/7804/7810/7814

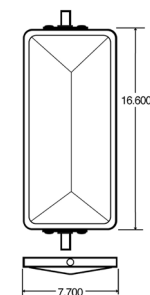

7 IN X 16 IN

Part Number	Housing Color	Housing Material	Mounting Bracket	Plug Side 2
97866	Silver	Stainless Steel	West Coast Rigid Bracket	Stripped End

## 7"X 16", HEATED

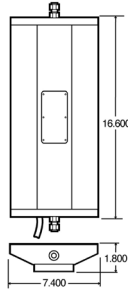

- Freightliner/Sterling style replacement
- Silvered mirror glass resists pitting, peeling and corrosion
- Glass is cushioned in a vinyl ozone-resistant gasket
- Designed as a rod-through style head with a 5/16"-18 threaded rod
- Heated version has a field replaceable PTC heating element that provides continuous heat even in sub-zero temperatures
- Bright stainless steel, painted steel or economical aluminum finishes
- Fits most standard OEM west coast brackets and mounts on two 5/16"-18 bolts
- Replaces Signal-Stat 7815-7819 series



Part Number	Housing Color	Housing Material	Mounting Bracket	Plug Side 2
97837	Silver	Stainless Steel	West Coast Rigid Bracket	Stripped End

## 7"X 16", HEATED

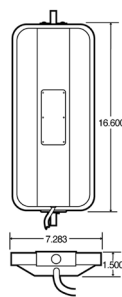

- Full 1/4" glass is cushioned with a vinyl gasket and meets OEM requirements
- Features a bright stainless steel finish
- Field replaceable PTC heating element that provides continuous heat even in sub-zero temperatures
- Direct replacement for many OEM mirrors
- Replaces Signal-Stat 7084/7085 series



Part Number	Housing Color	Housing Material	Mounting Bracket	Plug Side 2
97826	Silver	Stainless Steel	West Coast Rigid Bracket	Stripped End
97827	Silver	Stainless Steel	West Coast Rigid Bracket	Stripped End

## 7"X 16", HEATED

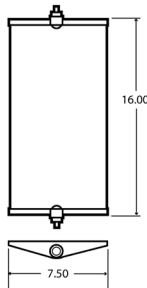

- OEM replacement for International S-series and other trucks
- Full vinyl gasket insulated glass
- Heated mirrors feature International "bullet style" door plug



Part Number	Housing Color	Housing Material	Mounting Bracket	Plug Side 2
97625	Silver	Aluminum	West Coast Rigid Bracket	3 Prong Round Plug

## 7"X 16", HEATED



- Silvered mirror glass resists pitting, peeling and corrosion
- Glass is cushioned in a vinyl ozone-resistant gasket
- Fits most standard OEM brackets with T-bolt mount
- Designed with a single-piece mirror back
- Bubble back and rib back designs are popular for use on construction and delivery trucks
- Replaces Signal-Stat 7081, 7082, 7083 and 7093

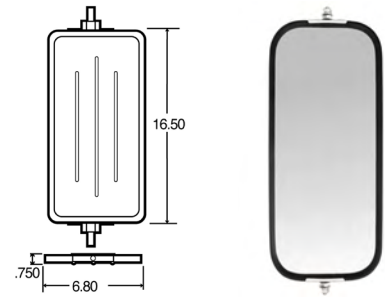

7 IN X 16 IN

Part Number	Housing Color	Housing Material	Mounting Bracket	Plug Side 2
97650	Black	Steel	West Coast Rigid Bracket	Stripped End

## 7"X 16", HEATED



- Silvered mirror glass that resists pitting, peeling and corrosion
- Light weight stainless steel housing weighs only 4 lbs.
- Features a sealed gearless motor that withstands manual adjustment without damage
- Turning mechanism designed to eliminate over rotation with built-in 60° adjustment limits
- Field replaceable PTC heating element that provides continuous heat even in sub-zero temperatures
- Motorized version includes electrical wiring, switches and installation instructions
- Fits most standard OEM brackets and mounts on two 5/16" -18 bolts
- 97840 replaces Moto Mirror R7-2410 and Velvac #2010
- 97842 replaces Moto Mirror L3-2310
- Replaces Signal-Stat 7087/A

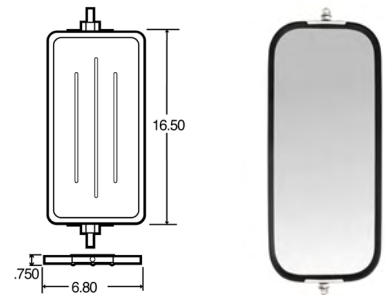

7 IN X 16 IN

Part Number	Housing Color	Housing Material	Mounting Bracket	Plug Side 2
97840	Silver	Stainless Steel	West Coast Rigid Bracket	Female Blade Terminal

## SIGNAL-STAT, 5" ROUND

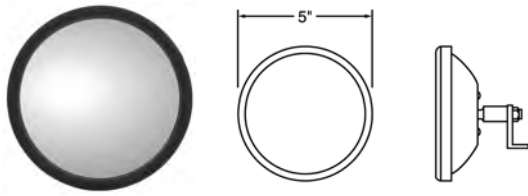

- Mounts with a 5/16" adjustable, female threaded ball stud to help prevent thread damage
- Includes L-bracket
- Features flat glass surface
- Replaces Signal-Stat 7319/7328



Part Number	Housing Color	Housing Material	Mounting Bracket
97611	Black	Stainless Steel	L Bracket
97612	White	Stainless Steel	L Bracket

## SIGNAL-STAT, 2"X 8" RECTANGULAR

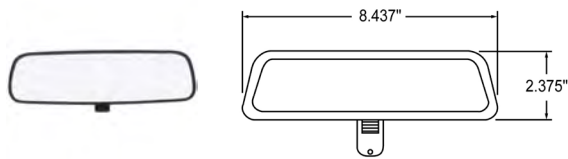

- Day and night prismatic ground glass
- Application button included (glue not included)
- Fits most Chrysler and import vehicle windshields



Part Number	Housing Color	Housing Material	Mounting Bracket
7619	Black	Vinyl	Window Mount

## SIGNAL-STAT, 2"X 10" RECTANGULAR

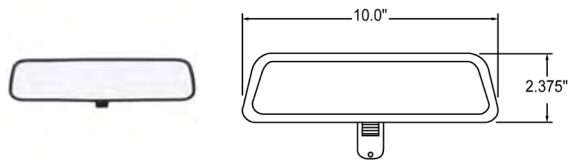

- Day and night prismatic ground glass
- Application button included (glue not included)
- Fits most AMC, Ford and GM windshields



Part Number	Housing Color	Housing Material	Mounting Bracket
7618	Black	Vinyl	Window Mount

## SIGNAL-STAT, 5.5"X 7.5" RECTANGULAR



- Day and night prismatic ground glass
- Application button included (glue not included)
- Fits most AMC, Ford and GM windshields

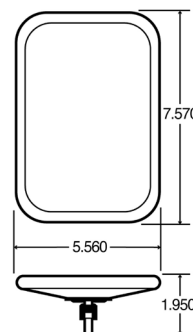

Part Number	Housing Color	Housing Material
97653	Silver	Steel
97654	Black	Steel
97807	White	Steel



### 5.5"X 7.5" RECTANGULAR



- For small pick-ups
- Center bracket mount
- Ozone-resistant vinyl gasket
- Replacement head for part #97678
- Replaces Signal-Stat 7052

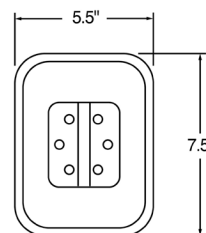

Part Number	Housing Color	Housing Material	Mounting Bracket
97655	Silver	Stainless Steel	Center Bracket

5.5 IN X 7.5 IN RECTANGULAR

### 5.5"X 7.5" RECTANGULAR



- Silvered glass that resists pitting, peeling and corrosion
- Glass is mounted in vinyl gasket
- Features white, electrostatic-painted steel finish
- 5-1/2" x 7-1/2" mirror head uses 5/16" - 16 adjustable, female threaded ball stud to prevent thread damage
- For use as a general purpose mirror
- Replaces Signal-Stat 7041/7075/7076

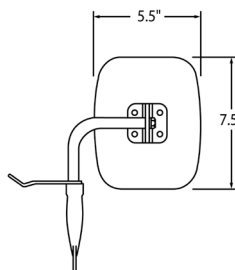

Part Number	Housing Color	Housing Material	Mounting Bracket
97678	Silver	Stainless Steel	Tripod Bracket

5.5 IN X 7.5 IN RECTANGULAR

### 5.5"X 8.5" RECTANGULAR



- Features flat glass surface
- Popular size is ideal for use on moving and package delivery vehicles
- Soft vinyl gasket fully encases mirror glass to cushion against damaging vibration
- 5/16" adjustable ball stud mounting
- Replaces Signal-Stat 7059

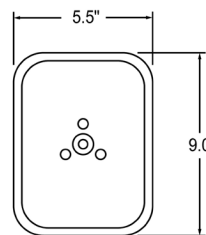

Part Number	Housing Color	Housing Material	Mounting Bracket
97656	Silver	Stainless Steel	L Bracket
97657	Black	Stainless Steel	L Bracket

5.5 IN X 8.5 IN RECTANGULAR

## SIGNAL-STAT, 5.5"X 8.5" RECTANGULAR

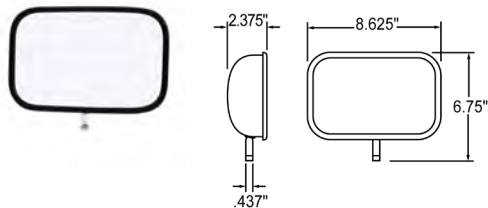

- OEM replacement for Ford F-Series
- Replacement for 7217 and 7218 assemblies
- 1/4" female ball stud



Part Number	Housing Color	Housing Material	Position
7223	Silver	Stainless Steel	LH
7224	Silver	Stainless Steel	RH

## SIGNAL-STAT, 5.5"X 8.5" RECTANGULAR

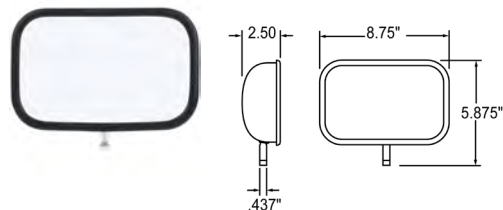

- Universal replacement head
- Replacement head for 7555 and 7557
- 1/4" female ball stud



Part Number	Housing Color	Housing Material	Mounting Bracket
7268	Black	ABS	Window Mount
7269	Chrome	ABS	Window Mount

## SIGNAL-STAT, 5.5"X 8.5" RECTANGULAR

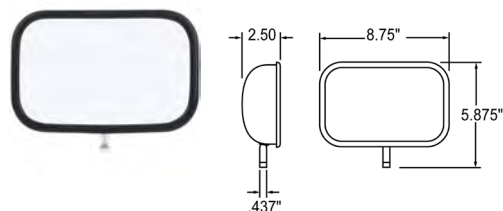

- Universal replacement head
- Replacement head for 7555 and 7557
- 1/4" female ball stud



Part Number	Housing Color	Housing Material	Mounting Bracket
7973D	Black	Plastic	Adjustable Arm

## 5"X 9" RECTANGULAR



- Textured finish
- Lightweight plastic design
- First surface chrome glass
- Shatterproof glass
- SST Hardware
- 450 MM spherical radius
- Mounting holes are 2.75" apart
- Mounting holes have .275" clearance

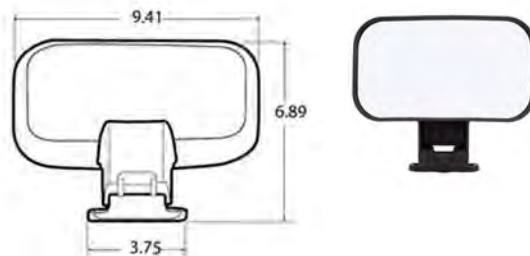

Part Number	Housing Color	Housing Material
97384	Black	Plastic

5 IN X 9 IN RECTANGULAR

## SIGNAL-STAT, 5"X 9" RECTANGULAR



- Ford FOTZ-17696B and FOTZ-17696A
- Fits F-Series Pickups, Broncos 1987-1991; Vans 1975-1991
- Door mount with swing away feature
- Aerodynamic design
- Aluminum arm
- Stainless steel is corrosion-free

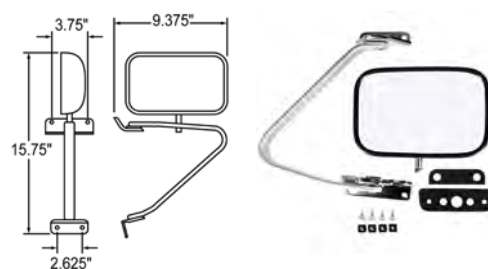

Part Number	Housing Color	Housing Material	Mounting Bracket	Position
7217	Silver	Stainless Steel	Angled Bracket	LH
7218	Silver	Stainless Steel	Angled Bracket	RH

5 IN X 9 IN RECTANGULAR

## SIGNAL-STAT, 5"X 9" RECTANGULAR



- Fits both left and right sides
- Door mount with swing away feature
- Aluminum arm
- ABS plastic is corrosion-free

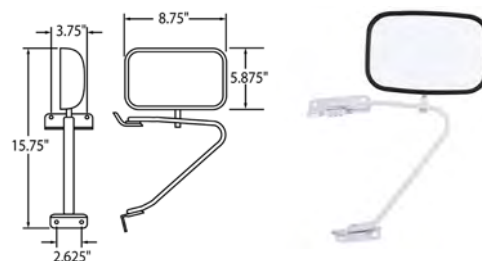

Part Number	Housing Color	Housing Material	Mounting Bracket
7555	Chrome	ABS	Door Mount

5 IN X 9 IN RECTANGULAR

## 6"X 6.5" RECTANGULAR

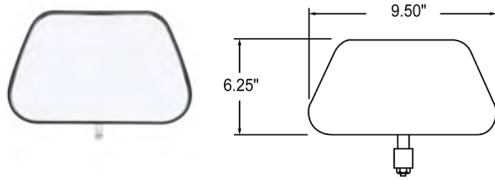

- Silvered mirror glass resists pitting, peeling and corrosion
- Glass is mounted in vinyl, ozone-resistant gasket
- Brushed painted or stainless steel finish
- For use with 97846 and other assemblies
- Replaces Signal-Stat 7400-7405



Part Number	Housing Color	Housing Material
97674	Silver	Stainless Steel
97675	Black	Stainless Steel
97676	White	Stainless Steel

## 6.25"X 9.5" RECTANGULAR

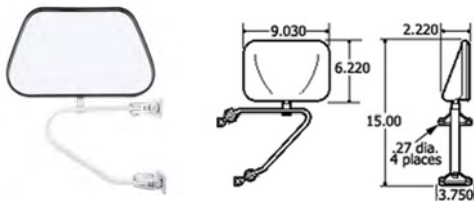

- Ideal for domestic and import pick-ups, vans and RVs
- Swing away brackets prevent damage
- Fits right or left side
- Corrosion-free ABS plastic and durable stainless steel models available
- Comes complete with aluminum arms and hardware
- Adjustable head assembly
- Replaces Signal-Stat 7572/7574/7571



Part Number	Housing Color	Housing Material
97750	Chrome	Plastic

## 6.25"X 9.5" RECTANGULAR

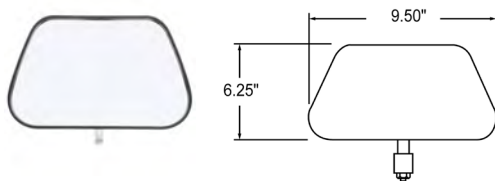

- Replacement head for part #97750
- Features chrome-plated plastic corrosion free housing
- Replaces Signal-Stat 7065



Part Number	Housing Color	Housing Material
97794	Chrome	Plastic

## 6.5"X 10" RECTANGULAR



- Silvered mirror glass resists pitting, peeling and corrosion
- Glass is mounted in vinyl, ozone-resistant gasket
- Brushed painted or stainless steel finish
- For use with 97846 and other assemblies
- Replaces Signal-Stat 7400-7405

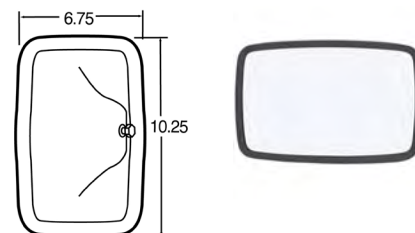

Part Number	Housing Color	Housing Material
97672	Black	Stainless Steel
97673	White	Stainless Steel
97847	Silver	Stainless Steel

6.5 IN X 10 IN RECTANGULAR

## 7"X 9" RECTANGULAR



- Silvered mirror glass resists pitting, peeling and corrosion
- Glass is mounted in vinyl gasket
- 7" x 9" mirror head mounts with 5/16" - 18 female threaded ball stud
- Replaces Signal-Stat 7067/7068

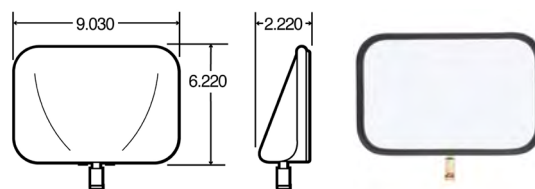

Part Number	Housing Color	Housing Material
97659	Black	Stainless Steel

7 IN X 9 IN RECTANGULAR

## SIGNAL-STAT, 7"X 9" RECTANGULAR



- GM 156976331 and 15697332
- Fits Suburban, Blazer, Yukon and Tahoe
- Pillar mount - near corner of side window
- Right hand mirror is slightly convex
- Chrome-plated steel is corrosion free
- Black zinc die-cast base

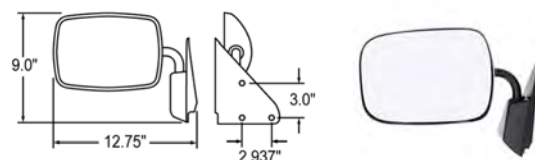

Part Number	Housing Color	Housing Material	Mounting Bracket
7519	Chrome	Steel	Pillar Mount

7 IN X 9 IN RECTANGULAR

## SIGNAL-STAT, 7"X 9" RECTANGULAR



- Fits Chevy and GMC vans and pick-ups
- Extra wide field of vision
- Universal mounting bracket, fits right or left side
- Rust and corrosion resistant

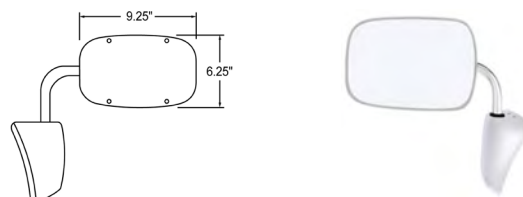

Part Number	Housing Color	Housing Material
7575	Chrome	Steel

7 IN X 9 IN RECTANGULAR

## SIGNAL-STAT, 7"X 14" RECTANGULAR

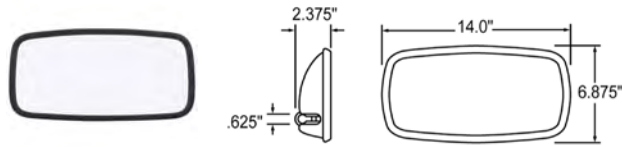

- Convex glass with no distortion
- Does not meet FMVSS 111 requirements for West Coast Mirrors
- Use for added safety on off-highway equipment
- Fits 5/8" O.D. mirror tubes
- Black ABS plastic housing
- Includes mounting clamp which tightens onto mirror tube with one screw



Part Number	Housing Color	Housing Material
7460	Black	Plastic

## 7.5"X 10.5" RECTANGULAR

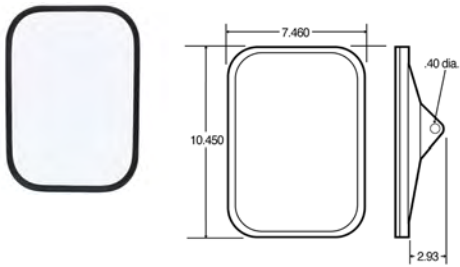

- Silvered mirror glass resists pitting, peeling and corrosion
- Glass is mounted in vinyl gasket
- Features bright stainless steel finish
- 7-1/2" x 10-1/2" mirror head uses center mount brackets to attach to assembly
- For use as a replacement for 97852 mirror assemblies
- Stainless steel replacement head for 97681
- Replaces Signal-Stat 7053/7054



Part Number	Housing Color	Housing Material
97660	White	Stainless Steel
97805	Silver	Stainless Steel

## 7.5"X 10.5" RECTANGULAR

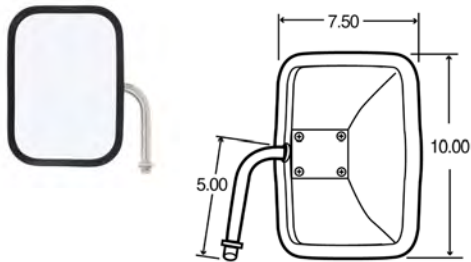

- Popular replacement for Ford, Chevy and Dodge trucks
- Features internal stainless steel elbow



Part Number	Housing Color	Housing Material	Mounting Bracket	Bracket Length
97661	Silver	Stainless Steel	Elbow Tripod Bracket	4in
97662	Silver	Stainless Steel	Elbow Tripod Bracket	5in

## 7.5"X 10.5" RECTANGULAR



- Fits both right and left side of Chevy, Ford, GMC and other pick-ups and vans
- Features "second surface" silvered glass that resists pitting, peeling and corrosion
- Glass is mounted in vinyl gasket
- Slotted top bracket allows assembly to fit most light and medium duty vehicles
- Fits either the left or right side
- Assembly features bright stainless steel finish
- Includes 7-1/2" x 10-1/2" mirror, mounting hardware and instructions
- Replaces Signal-Stat 7546/7560

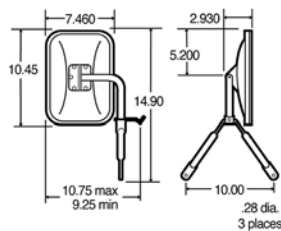

7.5 IN X 10.5 IN RECTANGULAR

Part Number	Housing Color	Housing Material	Mounting Bracket
97680	White	Stainless Steel	Tripod Bracket
97852	Silver	Stainless Steel	Tripod Bracket

## 7.5"X 10.5" RECTANGULAR



- Head can be positioned outside for wide vehicles or inside for narrow clearances
- Mounts below eye level to improve visibility to the front of vehicle
- Rugged stainless steel bracket
- Kit includes mounting brackets and instructions
- Designed for full size pick-up trucks
- Size: 7-1/2" x 10-1/2" mirror head
- Replaces Signal-Stat 7559

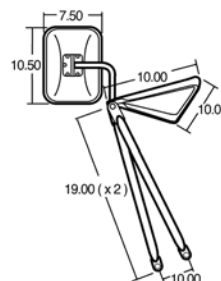

7.5 IN X 10.5 IN RECTANGULAR

Part Number	Housing Color	Housing Material	Mounting Bracket
97681	Silver	Stainless Steel	Tripod Bracket

## 7.5"X 10.5" RECTANGULAR



- Designed for full size pick-up trucks
- Extendable for trailer towing by swinging head out
- Glass mounted in ozone-resistant vinyl gasket
- Kit includes mounting hardware and instructions

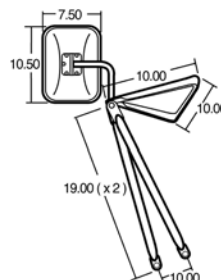

7.5 IN X 10.5 IN RECTANGULAR

Part Number	Housing Color	Housing Material	Mounting Bracket
97682	Silver	Stainless Steel	Tripod Bracket

## SIGNAL-STAT, 2" ROUND

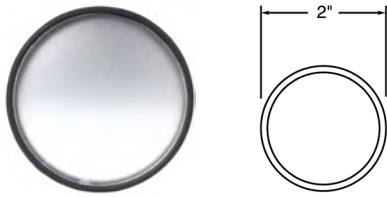

- Eliminates blind spots
- Adhesive back mirrors will mount on any clean flat surface
- Triples viewing area
- Black plastic housing
- Enhances viewing area for rectangular and square OEM side view mirrors



Part Number	Housing Color	Housing Material
7038	Black	Plastic

## SIGNAL-STAT, 3" ROUND

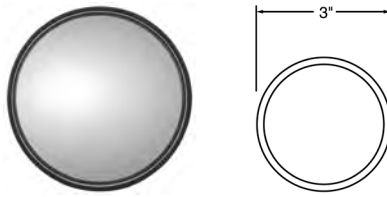

- Eliminates blind spots
- Adhesive back mirrors will mount on any clean flat surface
- Triples viewing area
- Black plastic housing
- Enhances viewing area for rectangular and square OEM side view mirrors



Part Number	Housing Color	Housing Material
7039	Black	Plastic

## SIGNAL-STAT, 4" ROUND

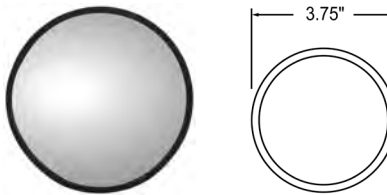

- Eliminates blind spots
- Adhesive back mirrors will mount on any clean flat surface
- Triples viewing area
- Black plastic housing
- Enhances viewing area for rectangular and square OEM side view mirrors



Part Number	Housing Color	Housing Material	Packaging Type
7044	Black	Plastic	
7044DB	Black	Plastic	Display

## TRUCK-LITE, 5" ROUND

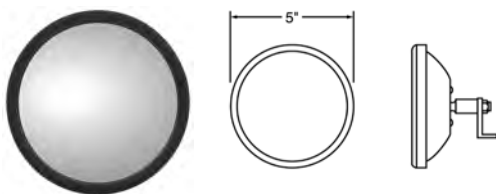

- Zinc-plated universal mounting kit
- Round with universal mounting kit
- L-bracket included
- Mounts with a 5/16" adjustable, female threaded ball stud to help prevent thread damage
- Replaces Signal-Stat 7313/7314/7315



Part Number	Housing Color	Housing Material	Mounting Bracket
97618	Silver	Stainless Steel	L Bracket
97619	Black	Stainless Steel	L Bracket
97620	White	Stainless Steel	L Bracket

2 IN ROUND

3 IN ROUND

4 IN ROUND

5 IN ROUND



## 5" ROUND



- Convex glass is mounted in vinyl gasket for extra protection
- Available in bright stainless steel or black electrostatic-painted finishes
- Mounts with a 5/16" adjustable, female threaded ball stud to help prevent thread damage
- Includes L-bracket for ease in replacement
- Replaces Signal-Stat 7061/7062

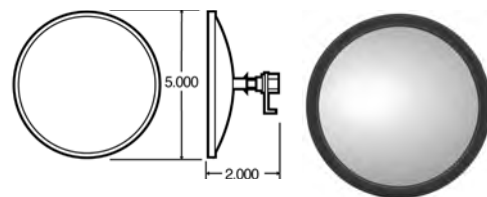

5 IN ROUND

Part Number	Housing Color	Housing Material	Mounting Bracket
97802	Black	Steel	L Bracket
97872	Silver	Steel	L Bracket

## 6" ROUND



- Zinc-plated universal mounting kit
- Round with universal mounting kit
- L-bracket included
- Mounts with a 5/16" adjustable, female threaded ball stud to help prevent thread damage
- Replaces Signal-Stat 7316/7317/7318

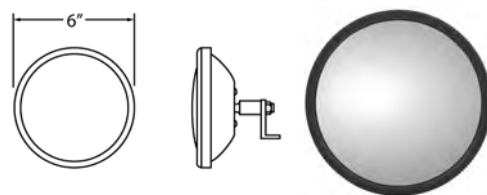

6 IN ROUND

Part Number	Housing Color	Housing Material	Mounting Bracket
97621	Silver	Stainless Steel	L Bracket
97622	Black	Stainless Steel	L Bracket
97623	White	Stainless Steel	L Bracket

## 6" ROUND



- Convex mirror replacement heads
- L-bracket included
- Mounting: 5/16" - 24 female ball stud
- Replaces Signal-Stat 7070/7071/7072

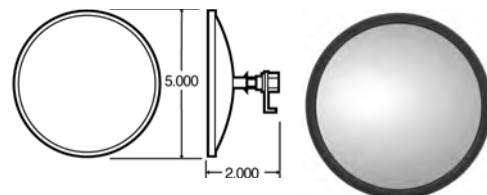

6 IN ROUND

Part Number	Housing Color	Housing Material	Mounting Bracket
97819	Silver	Steel	L Bracket
97820	Black	Steel	L Bracket

7.5 IN ROUND

### 7.5" ROUND

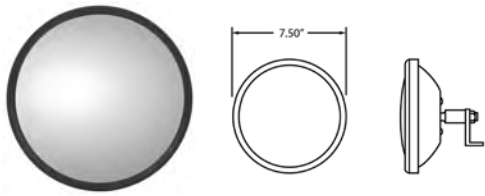

- Includes L-bracket
- Mounting: 5/16" female adjustable ball stud and bolt
- Replaces Signal-Stat 7077



Part Number	Housing Color	Housing Material	Mounting Bracket
97815	Silver	Stainless Steel	L Bracket
97816	Black	Stainless Steel	L Bracket
97817	Silver	Stainless Steel	L Bracket

8 IN ROUND

### 8" ROUND

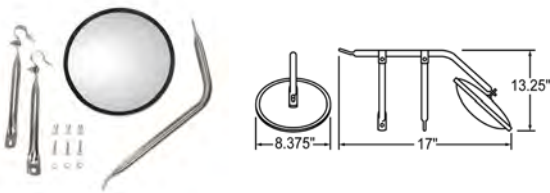

- Universal tripod bracket mounts easily to most Ford, Chevy and Dodge Vans
- Assembly includes 8" mirror head, tripod bracket, stainless steel hardware and fasteners
- Primarily used for rear vision when backing up vehicle
- 5/16" adjustable female ball stud and mount
- Replaces Signal-Stat 7770/7771



Part Number	Housing Color	Housing Material	Mounting Bracket
97664	Black	Stainless Steel	Tripod Bracket
97665	White	Stainless Steel	Tripod Bracket

8 IN ROUND

### 8" ROUND

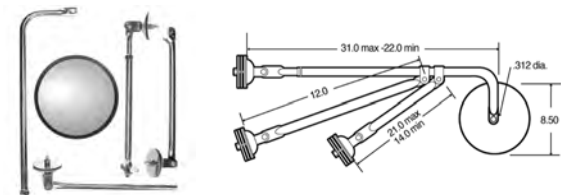

- Designed for conventional long nose trucks
- Bell mounts include 3" coated washers and 3" steel washers to prevent damage to fiberglass fenders
- Main arm expands from 22" to 31"; top support arm expands from 14" to 21"; bottom support arm is 12", non-adjustable



Part Number	Housing Color	Housing Material	Mounting Bracket
97686	Black	Stainless Steel	Tripod Bracket

8 IN ROUND

### 8" ROUND

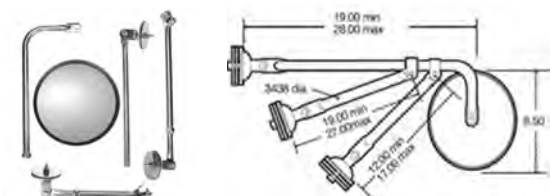

- Designed for newer aerodynamic styled heavy duty trucks
- Fits most fiberglass, steel and aluminum fenders and hoods
- Stainless steel construction and fasteners



Part Number	Housing Color	Housing Material	Mounting Bracket
97687	Black	Stainless Steel	Tripod Bracket

## 8" ROUND



- Kit includes convex mirror head, nickel-plated brass compression nuts, straight and curved arm bracket, installation instructions



Part Number	Housing Color	Housing Material	Mounting Bracket
97688	Black	Stainless Steel	Curved Arm

8 IN ROUND

## 8.5" ROUND



- Features a black, electrostatic-painted finish
- Acrylic mirror is mounted in a vinyl gasket
- Extra-wide design helps eliminate blind spots for medium duty vehicles
- Mounts on a 5/16" adjustable, female threaded ball stud to prevent thread damage
- For use on many medium duty vehicles and buses
- Includes L-bracket for ease of replacement
- Replaces Signal-Stat 7046

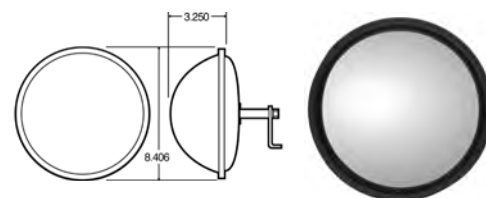

Part Number	Housing Color	Housing Material	Mounting Bracket
97606	Silver	Steel	L Bracket

8.5 IN ROUND

## 8.5" ROUND



- Offset mounting stud
- Includes L-bracket
- 2.5 amps 12 VDC only
- 60" wire length (can use switch #102 or #132)
- Heated mirror installation kit #7940 is available
- Mounting: 5/6" female threaded adjustable ball stud with 1/2" bolt
- Replaces Signal-Stat 7078/7079/7091

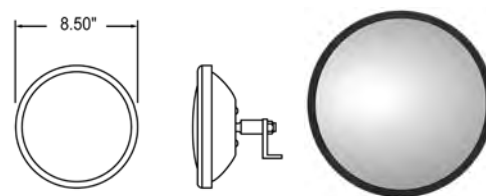

Part Number	Housing Color	Housing Material	Mounting Bracket	Plug Side 2
97614	Silver	Steel	L Bracket	Stripped End
97615	Black	Steel	L Bracket	Stripped End

8.5 IN ROUND

## 8.5" ROUND

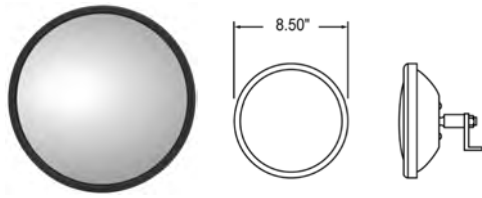

- Popular school bus convex head
- Center stud
- Includes L-bracket
- Mounting: 5/16" female adjustable ball stud and bolt
- Replaces Signal-Stat 7073/7074/7090



Part Number	Housing Color	Housing Material	Mounting Bracket
97803	Silver	Steel	L Bracket
97804	Black	Steel	L Bracket
97814	Silver	Steel	L Bracket

## 8.5" ROUND



- Features a black, electrostatic-painted finish
- Acrylic mirror is mounted in a vinyl gasket
- Extra-wide design helps eliminate blind spots for medium duty vehicles
- Mounts on a 5/16" adjustable, female threaded ball stud to prevent thread damage
- For use on many medium duty vehicles and buses
- Includes L-bracket for ease of replacement
- Replaces Signal-Stat 7046



Part Number	Housing Color	Housing Material	Mounting Bracket
97831	Black	Steel	L Bracket

## 10.5" ROUND

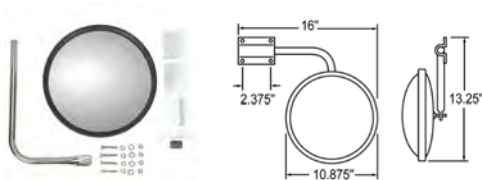

- Universal mounting bracket fits on step vans and other vehicles with flat mounting area
- Assembly includes 10-1/2" mirror head, reinforced 3/4" O.D. tubing arm, heavy duty mounting brackets and stainless steel hardware
- 5/16" adjustable female ball stud and mount
- Replaces Signal-Stat 7780/7781



Part Number	Housing Color	Housing Material	Mounting Bracket
97862	Black	Stainless Steel	Universal Mounting Bracket

## 10.5" ROUND

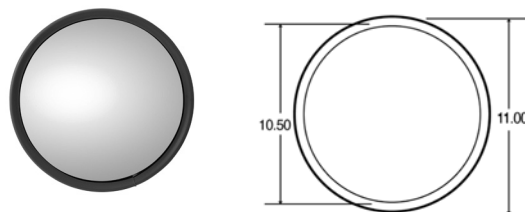

- Replacement mirror head for vans, straight trucks and panel trucks
- Directly replaces mirror head on 97862 assemblies
- 5/16" adjustable female ball stud and bolt included
- Acrylic lens mounted in ozone vinyl
- Increases visibility in blind spots
- Replaces Signal-Stat 7796/7797



Part Number	Housing Color	Housing Material	Mounting Bracket
97863	Black	Steel	Universal Mounting Bracket

## 12" ROUND



- Ideal spot mirror for large off-highway construction and earth moving equipment
- Popular as interior spot mirror on transit bus applications
- Internal construction features reinforced retainers for durability and strength
- Corrosion resistant powder coated finish
- Large 1" steel ball stud with 3/8" - 24 threads for secure mounting and precise positioning
- Soft vinyl gasket fully encases mirror glass to cushion against damaging vibration
- Replaces Signal-Stat 7419/7420/7421

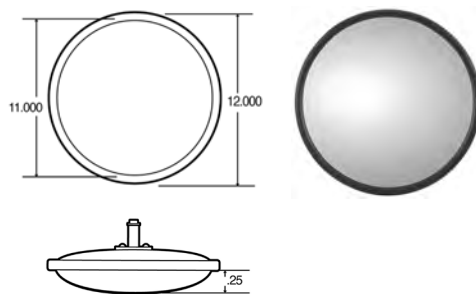

12 IN ROUND

Part Number	Housing Color	Housing Material
97609	Black	Steel
97610	White	Steel
97835	Gray	Steel

## 12" ROUND



- Bracket fits most step, cargo and delivery vans
- Reinforced 3/4" tubing and heavy-duty bracket

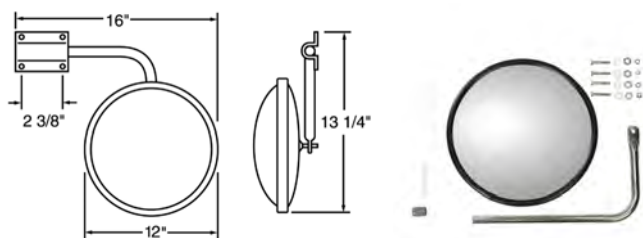

12 IN ROUND

Part Number	Housing Color	Housing Material	Mounting Bracket
97667	White	Cold Rolled Steel	90 Degree Mounting Arm

## SIGNAL-STAT, 4"X 5" RECTANGULAR



- Eliminates blind spots
- Adhesive back mirrors will mount on any clean flat surface
- Triples viewing area
- Black plastic housing
- Enhances viewing area for rectangular and square OEM side view mirrors

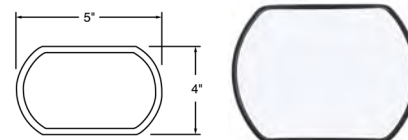

4 IN X 5 IN RECTANGULAR

Part Number	Housing Color	Housing Material	Packaging Type
7048	Black	Plastic	
7048DB	Black	Plastic	Display

## 4"X 8" RECTANGULAR

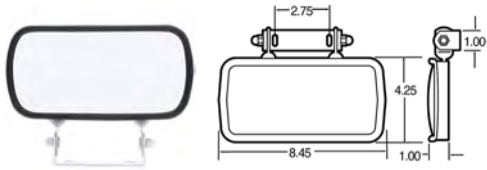

- Features "second surface" silvered glass that resists pitting, peeling and corrosion
- Features a bright stainless steel finish
- Convex mirror adds vision to trucks, buses and other vehicles
- Fits either side of the vehicle
- Includes stainless steel mounting bracket
- Mounts above down window
- Replaces Signal-Stat 7057



Part Number	Housing Color	Housing Material
97865	Silver	Stainless Steel

## 5"X 9" RECTANGULAR

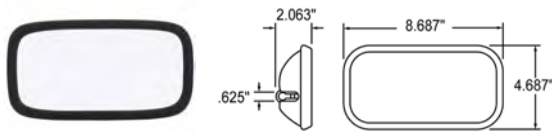

- Convex glass with no distortion
- Does not meet FMVSS 111 requirements for West Coast Mirrors
- Universal application for added safety
- Fits 5/8" O.D. mirror tubes
- Black ABS plastic housing
- Includes mounting clamp which tightens onto mirror tube with one screw



Part Number	Housing Color	Housing Material
7450	Black	ABS

## 6"X 6" RECTANGULAR

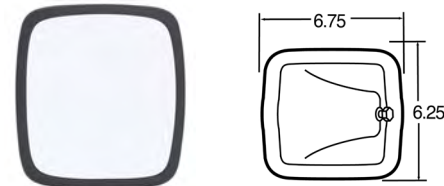

- Silvered mirror glass resists pitting, peeling and corrosion
- Glass is mounted in vinyl ozone-resistant gasket
- Brushed painted or stainless steel finish
- For use with 97846 and other assemblies
- Replaces Signal-Stat 7400-7405



Part Number	Housing Color	Housing Material
97670	Black	Stainless Steel
97671	White	Stainless Steel
97848	Silver	Stainless Steel

## 6"X 8" RECTANGULAR

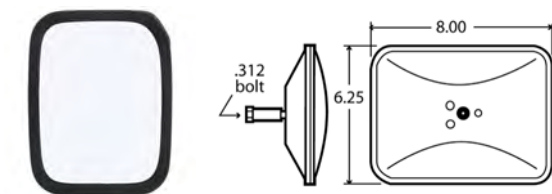

- Convex glass with no distortion
- Does not meet FMVSS 111 requirements for West Coast Mirrors
- Universal application for added safety
- Fits 5/8" O.D. mirror tubes
- Black ABS plastic housing
- Includes mounting clamp which tightens onto mirror tube with one screw



Part Number	Housing Color	Housing Material	Mounting Bracket
97602	Silver	Stainless Steel	Tripod Bracket West Coast Rigid Bracket
97603	Black	Stainless Steel	Tripod Bracket West Coast Rigid Bracket

# Looking for even more product information?

Visit [truck-lite.com](http://truck-lite.com)



**Powerful Search**



**360° Product Images**



**Easy-To-Find Replacement Parts**

MIRROR BRACKET

## WEST COAST MIRROR BRACKET

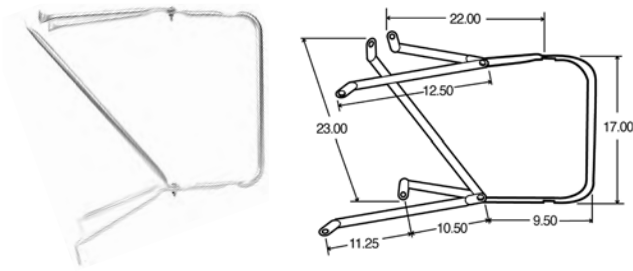

- Replacement for International Truck S-Series (4000-4700)
- Includes brackets, outer yoke, clamps and hardware
- Mirror not included



Part Number	Compatible Parts	Mount Type	Mount/Trim Material	Mount/Trim Color
97695	97624 Mirror Head, 97625 Mirror Head	Yoke	Silver	Aluminum

MOUNTING BRACKET

## MOUNTING BRACKET

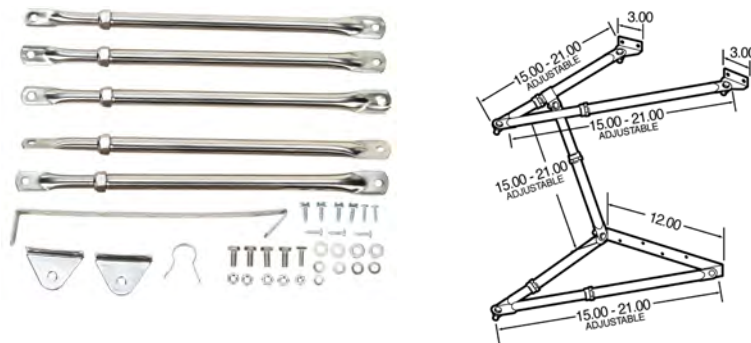

- Features heavy-duty, stainless steel construction
- Includes steady brace, hardware and assembly instructions
- Adjusts to fit most medium and heavy duty trucks
- For use with 6" x 16" or 7" x 16" west coast mirror heads
- Replaces Signal-Stat 7113/7115/7117



Part Number	Compatible Parts	Mount Type	Mount/Trim Material	Mount/Trim Color
97843	6 in x 16 in West Coast Mirror Heads, 7 in x 16 in West Coast Mirror Heads	West Coast Rigid Bracket	Silver	Steel

SAFETY YOKE BRACKET

## SAFETY YOKE BRACKET

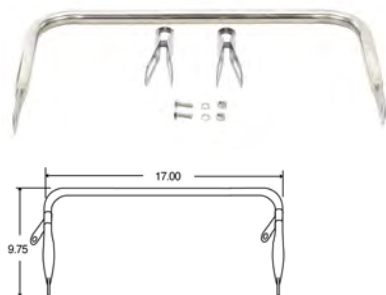

- Adds swing away feature to any West Coast assembly
- Provides protection against damage in tight spots
- Comes complete with mounting clamps
- Replaces Signal-Stat 7114/7118



Part Number	Compatible Parts	Mount Type	Mount/Trim Material	Mount/Trim Color
97725		Yoke	Silver	Steel
97726		Yoke	Black	Steel



## SCHOOL BUS BRACKET



- Black painted steel
- Extends 13"-25" after mounting
- Can be used with any ball stud convex mirror
- Replaces Signal-Stat 7110

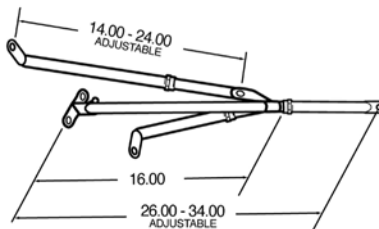

Part Number	Compatible Parts	Mount Type	Mount/Trim Material	Mount/Trim Color
97666	Convex Mirrors	Tripod Bracket	Black	Steel

SCHOOL BUS BRACKET

## BELL MOUNT BRACKET



- Features heavy-duty stainless steel construction
- Single extension-arm mounts to most fiberglass, steel or aluminum fenders
- For use with 6" or smaller convex mirror heads or added support to other brackets
- Bell mount design includes 3" plastic washers to prevent damage to fiberglass fenders
- Replaces Signal-Stat 7331/7332

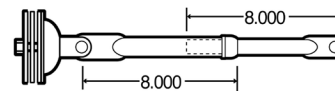

Part Number	Compatible Parts	Mount Type	Mount/Trim Material	Mount/Trim Color
97828	6 in or Smaller Convex Mirror	Fixed Mounting Arm	Silver	Steel
97829	Convex Mirrors	Tripod Bracket	Silver	Steel

BELL MOUNT BRACKET

## L BRACKET



- For convex mirrors
- For use with 5"-8-1/2" convex mirror heads
- Replaces Signal-Stat 7929

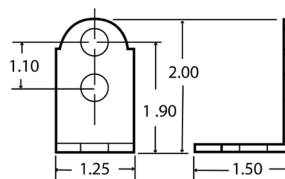

Part Number	Compatible Parts	Mount Type	Mount/Trim Material	Mount/Trim Color
97718	5 in to 8-1/2 in Convex Mirror Heads	Bracket Mount	Silver	Steel

L BRACKET

## 90 DEGREE MOUNTING BRACKET

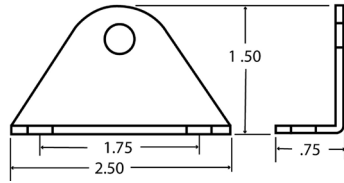

- Small 90-degree standard mounting bracket
- Stainless steel
- Door mount bracket for 97727 and 97843 mirror arm assemblies and 97633 and 97694 west coast mirror assemblies
- Mounting: 1-1/2" centers
- Replaces Signal-Stat 7926



Part Number	Compatible Parts	Mount Type	Mount/Trim Material	Mount/Trim Color
97876	Mirror Arm Assembly (97843), West Coast Mirror Assembly (97633, 97694)	90 Degree Mounting Arm	Silver	Steel

## EXTENSION BRACKET

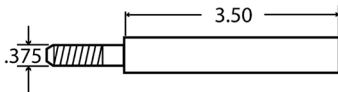

- 4" stainless steel extender
- Extends mirror heads on low mount tripod
- 3/8"-16 thread (course)
- For use with competitors mirror assemblies
- Replaces Signal-Stat 7924



Part Number	Compatible Parts	Mount Type	Mount/Trim Material	Mount/Trim Color
97730		Tripod Bracket	Chrome	Steel

## EXTENDER BRACKET

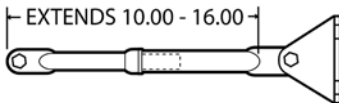

- Extends 10"-16"
- Black painted steel



Part Number	Compatible Parts	Mount Type	Mount/Trim Material	Mount/Trim Color
97719		180 Degree Mounting Arm	Black	Steel

## OFFSET ELBOW EXTENSION



- Replacement elbow for 97861 mirror
- Provides vertical extension for tripod mounted mirrors
- Replaces Signal-Stat 7936

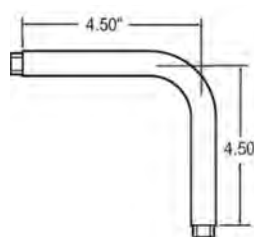

ELBOW EXTENSION

Part Number	Compatible Parts	Mount Type	Mount/Trim Material	Mount/Trim Color
97748	Large Rectangular Mirror Head (97805)	Tripod Bracket	Silver	Steel
97869		Tripod Bracket	Silver	Steel

## EXTENSION ARM



- For use in mounting convex mirrors to "below eye level" mirror assemblies
- 9-5/8" overall length, stainless steel
- Mounting on 8-3/8" centers
- Replaces Signal-Stat 7922

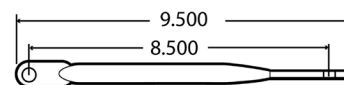

EXTENSION ARM

Part Number	Compatible Parts	Mount Type	Mount/Trim Material	Mount/Trim Color
97731	Convex Mirrors	180 Degree Mounting Arm	Silver	Steel

## MOUNTING ARM



- 6" body mounting arm
- Black painted steel
- Replaces Signal-Stat 7202

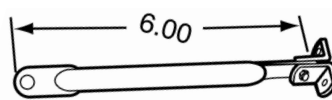

MOUNTING ARM

Part Number	Compatible Parts	Mount Type	Mount/Trim Material	Mount/Trim Color
97720		90 Degree Mounting Arm	Black	Steel

## UNIVERSAL SIDE CLAMP

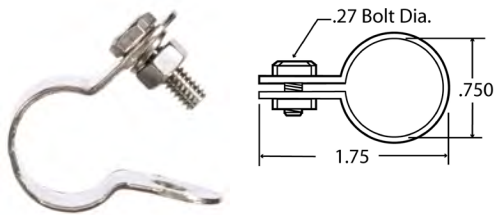

- Clamps onto 3/4" tubular arm
- Replacement for most west coast and tripod assemblies
- 1/4" holes
- Replaces Signal-Stat 7928



Part Number	Compatible Parts	Mount Type	Mount/Trim Material	Mount/Trim Color
97732	Signal-Stat 7928, Tripod Assembly, West Coast Mirror Assembly		Silver	Steel

## HEAD CLAMP

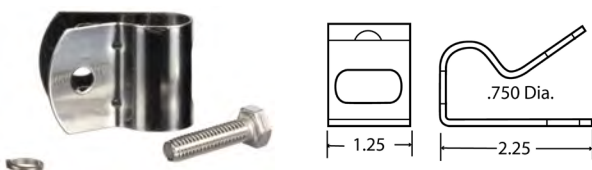

- Single piece stainless steel clamp and hardware
- Clamp has plastic coating to protect painted surfaces
- Replaces Signal-Stat 7932



Part Number	Compatible Parts	Mount Type	Mount/Trim Material	Mount/Trim Color
97733			Silver	Steel

## ADJUSTABLE MIRROR BRACE

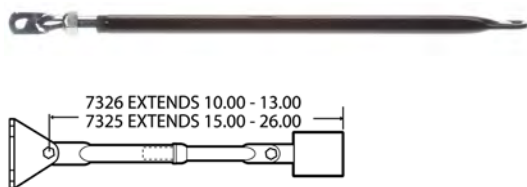

- 99721 extends from 15"-26"
- 99722 extends from 10"-13"
- Can be used as mirror bracket or brace with any convex or West Coast Mirror assembly
- Black painted steel
- Replaces Signal-Stat 7325/7326



Part Number	Compatible Parts	Mount Type	Mount/Trim Material	Mount/Trim Color
97721	West Coast Mirror Assembly	180 Degree Mounting Arm	Black	Steel
97722	West Coast Mirror Assembly	180 Degree Mounting Arm	Black	Steel

## HEATER ELEMENT



- Replacement heater element for West Coast mirrors
- Convert any West Coast mirror to a heated mirror head
- Improved temperature control limits the temperature to 145
- Replaces Signal-Stat 7930

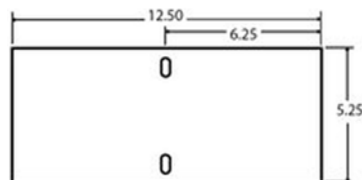

Part Number	Compatible Parts
97845	Signal-Stat 7930, West Coast Mirror

HEATER ELEMENT

## CONVEX MIRROR MOUNT



- Fits either 3/4" or 5/8" diameter tubing
- Attaches convex mirrors to other bracket with a two-part, clamshell style clamp
- Kit includes a 4-1/2" extension arm, and L-bracket, clamshell clamp pieces and hardware
- Replaces Signal-Stat 7941



Part Number	Compatible Parts	Mount Type	Mount/Trim Material	Mount/Trim Color
97823	Signal-Stat 7941		Silver	Steel

CONVEX MIRROR MOUNT

## UNIVERSAL SIDE MOUNTING, KIT



- Fits either 3/4" or 5/8" diameter tubing
- Attaches convex mirrors to other bracket with a two-part, clamshell style clamp
- Kit includes a 4-1/2" extension arm, and L-bracket, clamshell clamp pieces and hardware
- Replaces Signal-Stat 7205



Part Number	Compatible Parts	Mount Type	Mount/Trim Material	Mount/Trim Color
97849	Convex Mirror Head		Black	Steel

SIDE MOUNTING KIT

# REFLECTORS & REFLECTIVE TAPE

**REFLECTORS**

**Pages 486-489**

SERIES	PAGES
Round	486-487
Oval	487-488
Rectangular	488-489

**REFLECTIVE TAPE**

**Pages 490-491**

**WARNING TRIANGLES**

**Page 492**

## SIGNAL-STAT, ROUND, 2", ADHESIVE MOUNT, ACRYLIC



- Permanent adhesive backing
- Mounts on any clean flat surface
- Smaller diameter for applications where space is limited
- Replaces Truck-Lite 98008 series

Part Number	Reflector Color
45	Red
45A	Yellow



## SIGNAL-STAT, ROUND, 3", ADHESIVE MOUNT, ACRYLIC



- Permanent adhesive backing
- Mounts on any clean flat surface
- Replaces Truck-Lite 98005 series

Part Number	Reflector Color
47	Red
47A	Yellow
47DB	Red
47ADB	Yellow



## ROUND, 3", ADHESIVE MOUNT, TAPE

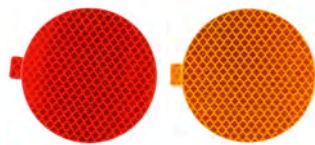

- Economical, reduced labor costs, no time installing screw-on reflectors, molded reflectors
- Easy to apply—simply bend, peel and apply
- No drilling or mechanical fasteners needed
- Meets and exceeds DOT and SAE requirements
- Application temperature range 40 degrees to 100 degrees Fahrenheit

Part Number	Reflector Color	
98175RB	Red	Basket
98175R	Red	
98175YB	Yellow	Basket
98175Y	Yellow	



## ROUND, 2", 1 SCREW, NAIL, RIVET, ACRYLIC



- Fast, permanent installation with nail, screw or rivet
- Designed to take extra force in center
- Use one #10 screw- 1/4" hole

Part Number	Reflector Color
52	Red
52A	Yellow



## ROUND, 3", 1 SCREW, NAIL, RIVET, ACRYLIC

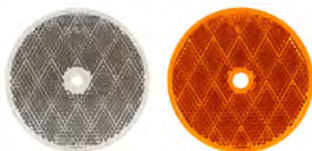

- Fast, permanent installation with nail, screw or rivet
- Designed to take extra force in center
- Use one #10 screw

Part Number	Reflector Color
98006C	Clear
98006R	Red
98006Y	Yellow





## ROUND, 4", 2 SCREW, ABS



Part Number	Reflector Color	Mount/Trim Color
98004R	Red	White
98004Y	Yellow	White

- Sonically welded sealed acrylic lens and ABS housing
- Replaces Signal-Stat 42A/42AD



REFLECTORS

## SIGNAL-STAT, ROUND, 3.5", 1 SCREW, ABS



Part Number	Reflector Color	Mount/Trim Color
57	Red	White
57A	Yellow	White

- 3.5" SAE Class A reflector hermetically sealed
- For use on trucks, trailers and other on and off road applications
- Designed for heavy OEM applications
- Molded insert for center-mount screw prevents cracking
- Use one #10 screw- 1/4" hole



REFLECTORS

## SIGNAL-STAT, ROUND, 3", 2 SCREW BRACKET MOUNT, ALUMINUM



Part Number	Reflector Color	Mount/Trim Color
41	Red	Silver
41A	Yellow	Silver
43	Red	Silver
43A	Yellow	Silver

- With 3" reflector and protective guard
- Replaces Truck-Lite 98030 Series



REFLECTORS

## OVAL, 2"X6", 2 SCREW, POLYCARBONATE



Part Number	Reflector Color	Mount/Trim Color
60558R	Red	Black

- Reflector cap best utilized in conjunction with the S/T/T & BU lamps to economically transform a four-lamp system into a two-lamp system by fitting into existing mounting hole

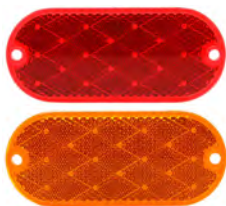

REFLECTORS

**OVAL, 2"X4", 2 SCREW, ACRYLIC**

- 98031R/Y version is mounted with two screws

Part Number	Reflector Color	Mount/Trim Color
98031R	Red	
98031Y	Yellow	

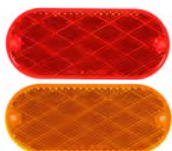
**OVAL, 2"X4", 2 SCREW, ADHESIVE MOUNT, ACRYLIC**

- Acrylic or polycarbonate reflector with adhesive backing

Part Number	Reflector Color	Mount/Trim Color
98001R	Red	
98001Y	Yellow	

**OVAL, 2"X4", 2 SCREW, ADHESIVE MOUNT, ACRYLIC**

- Can be used as stick-on by peeling off back paper or can be mounted with two screws

Part Number	Reflector Color
54	Red
54A	Yellow

**RECTANGLE, 1"X4", 2 SCREW, ADHESIVE MOUNT, ACRYLIC**

- Features acrylic lens
- Mounts with adhesive backing or screws

Part Number	Reflector Color	Mount/Trim Color
98003R	Red	
98003Y	Yellow	
98003RB	Red	Basket
98003YB	Yellow	Basket

**RECTANGLE, 2"X4", 2 SCREW, ABS**

- Mounts on any clean flat surface
- Mounts with 2 screws, not included
- Sealed acrylic lens and housing

Part Number	Reflector Color	Mount/Trim Color
98035R	Red	Black
98035Y	Yellow	Black



## SIGNAL-STAT, RECTANGLE, 1"X3", ADHESIVE MOUNT, ACRYLIC



Part Number	Reflector Color	Mount/Trim Color
31DB	Red	
31ADB	Yellow	
32DB	Red	Chrome
32	Red	Chrome
32ADB	Yellow	Chrome
32A	Yellow	Chrome

- Perfect for marking darkened areas of garage entrances, mailbox posts, agricultural equipment, etc.
- Permanent adhesive backing
- Mounts on any clean flat surface
- For cars, marine and utility trailers



REFLECTORS

## RECTANGLE, 2 SCREW, ADHESIVE MOUNT, ACRYLIC



Part Number	Reflector Color	Size
98153	Clear	1in x 12in
98154R	Red	1in x 12in
98155	Clear	1in x 11in

- Meets requirements of final NHTSA ruling - see Federal Regulations Charts for details
- Ideal for use in areas where mounting clearance is limited
- Adhesive backing or screw-on mounting
- Hermetically sealed construction
- 11" version has optics for vertical mounting

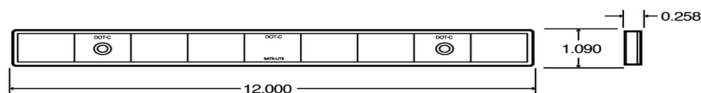

REFLECTORS

## RECTANGLE, 2"X3", ADHESIVE MOUNT, TAPE

Part Number	Reflector Color	Mount/Trim Color
98176RB	Red	
98176R	Red	
98176YB	Yellow	
98176Y	Yellow	

- Easy-to-apply, simply bend, peel and apply
- No drilling or mechanical fasteners needed
- Economical, reduced labor costs, no time installing screw-on reflectors
- Meets and exceeds DOT and SAE requirements
- Application temperature range 40 degrees to 100° Fahrenheit



REFLECTORS

## HEXAGON, 2"X5", ADHESIVE MOUNT, ACRYLIC



Part Number	Reflector Color	Mount/Trim Color
98033R	Red	
98033Y	Yellow	
98034R	Red	Chrome
98034Y	Yellow	Chrome

- Mounts with adhesive backing

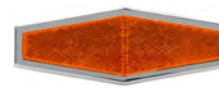

REFLECTORS

## PREMIUM REFLECTIVE MARKING TAPE



RED|WHITE



WHITE

- Premium grade, durable and rigid non-corroding conspicuity marking tape resistant to weather, dirt, aging and cracking
- Tough, durable film prevents lifting to look like new, with aggressive adhesion to last long after application
- Typically 1,000 candle power (white) for maximum long side detection distance performance, exceeding minimum requirements by four times
- Vivid, bright white color assures maximum reflectivity and superior daytime color, blending nicely with trailer skin
- Impact resistant, withstanding a blow from a forklift or loading dock and still retro-reflects
- Exceeds NHTSA and FHWA specifications
- Reflects light at all application angles on the roadway
- Quick application with an easy-release liner

Part Number	Reflector Color	Size
98100	White	2"x150'
98101	Red White	2"x150'
98102	Red White	3"x150'
98104	Red White	2"x18"
98105	White	2"x12"
98107	Red White	1.5"x150'
98108	Red White	2"x54"
98113	Red White	2"x2'

## STANDARD REFLECTIVE MARKING TAPE



RED



RED|WHITE



WHITE

- Tough, durable films resists cracking and lifting to look like new, long after application
- .010 thin tape with no open cell construction
- Typically 600 candle power for maximum long side detection distance performance, exceeding minimum requirements by 2.5 times
- Impact resistant, withstanding a blow from a forklift or loading dock and still retro-reflects
- Exceeds FHWA specifications
- Reflects light at all application angles on the roadway

Part Number	Reflector Color	Size
98111	Red	2"x150'
98126	White	2"x150'
98127	Red White	2"x150'
98136	Red White	2"x18"
98137	White	2"x12"
98138	Red White	2"x54"
98144	Red White	2"x48'
98146	Red White	2"x150'

## SIGNAL-STAT ECONOMY MARKING TAPE



RED|WHITE

- Tough, durable films resists cracking and lifting to look like new, long after application
- .010 thin tape with no open cell construction
- Impact-resistant, withstanding a blow from a forklift or loading dock and still retro-reflects
- Exceeds FHWA specifications, with DOT-C2 marking
- Reflects light at all application angles on the roadway

Part Number	Reflector Color	Size
37	Red White	2"x150'

## SCHOOL BUS PREMIUM REFLECTIVE MARKING TAPE

Part Number	Reflector Color	Size
98165	School Bus Yellow	2"x150'
98167	School Bus Yellow	1"x150'

- Meets all DOT requirements
- Thin, single layer construction
- No open cells that could allow tape to degrade with moisture and dirt intrusion
- Flat back allows for 100% adhesive contact
- Flexible, can bend 180 degrees or more with no cracking
- Will not crack, peel or delaminate
- Withstands repeated power washings
- Standard Series is covered by manufacturer's 5-year warranty



**SCHOOL BUS YELLOW**

REFLECTIVE TAPE

SCHOOL BUS PREMIUM

## SCHOOL BUS STANDARD REFLECTIVE MARKING TAPE

Part Number	Reflector Color	Size
98168	School Bus Yellow	2"x150'
98170	School Bus Yellow	1"x150'

- Meets all DOT requirements
- Thin, single layer construction
- No open cells that could allow tape to degrade with moisture and dirt intrusion
- Flat back allows for 100% adhesive contact
- Flexible, can bend 180 degrees or more with no cracking
- Will not crack, peel or delaminate
- Withstands repeated power washings
- Premium Series is covered by manufacturer's 10-year warranty



**SCHOOL BUS YELLOW**

REFLECTIVE TAPE

SCHOOL BUS STANDARD

## FOLDABLE WARNING TRIANGLE

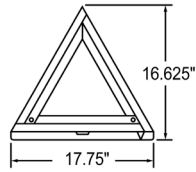

- Provides an added measure of safety for stranded motorists
- Comes complete with its own protective carrying case



Part Number	Mount Type
799	Free-Standing

## FOLDABLE WARNING TRIANGLE, KIT

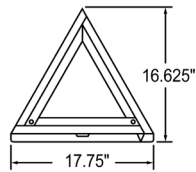

- Meets FMVSS 125 standards
- Triangle unfolds and locks together
- Non-skid heavy base withstands strong winds
- Reflex reflector strips form border for nighttime visibility - fluorescent orange inner triangle for daytime warning
- Housed in strong, heavy-duty box - 18" X 4" X 4-1/2"
- Shipped in individual corrugated box for added measure of protection
- Replaces Truck-Lite 97974



Part Number	Mount Type
798	Free-Standing

## FIXED WARNING TRIANGLE

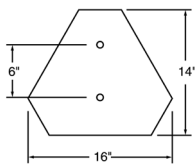

- Durable polycarbonate will not fade or rust
- Meets ANSI and ASAE standards S-276.5 for slow moving vehicles
- For agricultural vehicles, construction equipment and industrial vehicles



Part Number	Mount Type
797	2 Bolt & Nut Mount

## WARNING TRIANGLE REPLACEMENT BOX



- Meets FMVSS 125 standards
- Triangle unfolds and locks together
- Non-skid heavy base withstands strong winds
- Reflex reflector strips form border for nighttime visibility - fluorescent orange inner triangle for daytime warning
- Housed in strong, heavy-duty box - 18" X 4" X 4-1/2"
- Shipped in individual corrugated box for added measure of protection
- Replaces Truck-Lite 97974



Part Number
794

# Looking for even more product information?

Visit [truck-lite.com](https://truck-lite.com)



**Powerful Search**



**360° Product Images**



**Easy-To-Find Replacement Parts**

# MAINTENANCE



## **ANTI-CORROSION COMPOUNDS**

**Pages 498-499**

<b>SERIES</b>	<b>PAGES</b>
<b>NYK-77</b>	<b>498</b>
<b>Multi-Purpose Maintenance Spray</b>	<b>498</b>
<b>Nano Series</b>	<b>499</b>

## **TESTER KITS & ACCESSORIES**

**Pages 500-502**

## **LIGHT REPAIR KITS**

**Page 503**



# Maintenance Products

Whether it's our tried-and-true NYK-77 corrosion preventive compound or the all-new nano™ series of dielectric products, Truck-Lite has your lights and electrical systems covered.

## Products

**NYK-77 family, Multi-Purpose Maintenance Spray, nanoSeal, nanoShell**

## Sizes and applications

Truck-Lite's corrosion-preventative and dielectric compounds are available in a variety of sizes for a variety of applications.

### NYK-77

Trusted for over 40 years, and used daily in our production facilities, NYK compounds prevent corrosion for electrical contacts, switches and junction boxes.

*8oz can • 32oz can • 2oz tube • 5oz tube • 14oz cartridge*

### Multi-Purpose Maintenance Spray

It's right in the name. Our MPMS lubricates, prevents and removes corrosion and cleans and penetrates, invading hard-to-reach crevices and tight seams. It also displaces moisture and provides dielectric protection – a dynamic addition to any toolbox.

*14oz spray can*

### nanoSeal and nanoShell







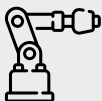

Because corrosion starts at the microscopic level, Truck-Lite's all-new, premium line of dielectric products stop corrosion before you ever see it happening. Use in lighting and engine assemblies, battery terminals, plug connections and more.

**nanoSeal:** *1oz tube • 2oz tube • 5oz tube • 14oz cartridge*

*8oz tub • 32oz tub • 14oz spray bottle • 64oz spray refill*

**nanoShell:** *8oz can*





(800) 562-5012 | [truck-lite.com](http://truck-lite.com)

 <p><b>Manufacturing &amp; Quality</b></p>	 <p><b>Testing &amp; Safety</b></p>
<p>Truck-Lite's range of dielectric products are overengineered to ensure the best protection for a vehicle's electrical system.</p>	<p>Truck-Lite maintenance products are exposed to strenuous environmental lab testing to ensure that they stand up to the harshest elements on the road.</p>
 <p><b>Performance &amp; Maintenance</b></p>	 <p><b>Customer Support</b></p>
<p><b>NYK-77</b></p> <ul style="list-style-type: none"> <li>• Specially formulated non-conductive sealant for all types of contacts and switches</li> </ul> <p><b>MPMS</b></p> <ul style="list-style-type: none"> <li>• Maintains lubricity under high loads for superior reduction of friction, heat and noise</li> <li>• High dielectric insulation against electrolysis</li> </ul> <p><b>nanoSeal/nanoShell</b></p> <ul style="list-style-type: none"> <li>• Hydrophobic</li> <li>• Operating temperature -40°F – 400°F</li> </ul>	<div data-bbox="890 1171 959 1247">  </div> <p><b>Customer Service</b></p> <p>(800) 562-5012 customerservice@truck-lite.com</p> <div data-bbox="884 1394 959 1470">  </div> <p><b>Technical Support</b></p> <p>(888) 562-5012 tltech@truck-lite.com</p> <p><b>Maintenance Warranties</b></p> <div data-bbox="874 1780 970 1864">  </div> <div data-bbox="995 1780 1091 1864">  </div>
<p>(800) 562-5012   truck-lite.com</p>	

# NYK-77, CORROSION PREVENTATIVE COMPOUND

- Corrosion preventive compound for electrical contacts, switches and junction boxes
- For periodic use with all electrical contact not using Fit 'N Forget connectors
- Available in a variety of sizes



	Part Number	Container Type	Container Volume
	97940	Can	8 oz
	97943	Can	32 oz
	97944	Tube	2 oz
	98013	Tube	5 oz
	97948	Cartridge	14 oz

# MULTI-PURPOSE MAINTENANCE SPRAY



- Quickly loosens frozen or seized parts
- Invades hard-to-reach crevices and creeps through the tightest seams
- Displaces moisture
- Corrosion Control: Forms a protective thin film barrier to stop oxidation and prevent rust from spreading
- Dissolves corrosion oxide - stops rust on contact
- Maintains lubricity under high loads for superior reduction of friction, heat and noise
- Use on fifth wheel springs and rails, glad hands, control linkages, roll-up doors, hinges and latches, chains and pulleys and more
- Outperforms other penetrants
- Prevents and removes corrosion build-up
- High dielectric insulation against electrolysis
- Extreme pressure lubricant
- For use on connectors including ABS, 4-13 way plugs and sockets, battery terminals and more



Part Number	Container Type	Container Volume
97946	Can	14 oz

# NANO SERIES, CORROSION PREVENTATIVE COMPOUND



- No curing or drying time needed
- Hydrophobic – resists water and moisture
- Operating temperature of -40°F to +400°F
- Excellent dielectric strength
- Simple, even application
- Superior protection from oxidation
- Protects electrical contacts from breakdown
- caused by high temperature and high voltage



	Part Number	Container Type	Container Volume
	98050	Tube	2 oz
	98051	Tube	5 oz
	98052	Cartridge	14 oz
	98053	Can	8 oz
	98054	Can	32 oz
	98056	Bottle	14 oz
	98057	Refill Bottle	64 oz
	98058	Can	8 oz



Dielectric Gel/Spray adheres to metal surfaces to provide exceptional protection from corrosion and moisture. It is designed to extend component life and protect equipment in harsh environments and extreme temperature conditions. It is a smooth, tacky, water-resistant, nano-engineered compound with excellent chemical inertness. Truck-Lite recommends using nanoSeal spray on sealed connectors to prevent hydraulic lock from over-application.



Dielectric Enamel is an interior and exterior use coating that adheres to metal surfaces and creates a solid coating to provide exceptional protection from corrosion and moisture. It is designed to extend component life and protect against harsh corrosive environments.

LIGHT CHECK

## LIGHT CHECK



**Part Number**  
97330



- Today, the process of pre-inspecting your vehicle before you head out on the road is more important than ever
- This system is designed to speed up your inspection times, and virtually eliminates undetected electrical problems
- Features a remote-controlled active computer direct fault indication system, with 10 second automatic analysis of all electrical circuits
- The easy-to-read digital display provides a direct readout of electrical faults, including open circuits, open grounds, shorts and chassis ground faults
- Saves up to 25% of the time needed to troubleshoot and inspect trailer systems

LIGHT TEST KIT

## LIGHT TEST, KIT



**Part Number**  
96260



- Quickly checks functions of Truck-Lite LED and incandescent lamps
- Includes durable zipper bag to conveniently store included parts

LIGHT TEST KIT

## LIGHT TEST W/ POWER SUPPLY, KIT



**Part Number**  
96259



- Quickly checks functions of Truck-Lite LED and incandescent lamps
- Includes durable zipper bag to conveniently store included parts

POWER SUPPLY

## POWER SUPPLY



**Part Number**  
96257



LAMP & CIRCUIT CHECKER

## LAMP & CIRCUIT CHECKER



**Part Number**  
97100



- Compact and rugged tester quickly checks function of lamps and wiring
- Can be used with all Truck-Lite sealed incandescent lamps and wiring systems
- Uses one standard 9-volt battery (included)
- Replaces Signal-Stat 9516/9517

## TRAILER CABLE & CIRCUIT TESTER



- Compliment to the lamp and circuit tester
- Uses high quality brass pins for reliable contact
- LEDs quickly identify faulty circuits in either of the connector cord assembly or the tractor
- Designed for use with 12 or 24 volt systems and negative or positive ground vehicles

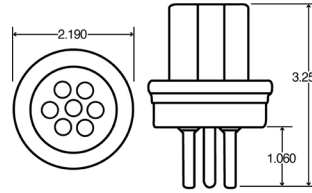

Part Number

97101

CABLE & CIRCUIT TESTER

## TERMINAL CONNECTOR CLEANER MASTER



- 4, 5 flat connectors, 6 round and 7-way spade pin terminals
- For male and female connections
- For tail and side maker light assemblies
- Maintain continuity and prevent circuit failure
- Quickly and precisely cut away corrosion



Part Number

96193

TERMINAL CONNECTOR CLEANER

## WIRE LEAD



- Can be used with all Truck-Lite sealed incandescent lamps and wiring systems



Part Number

97282

WIRE LEAD

## TEMP GAUGE

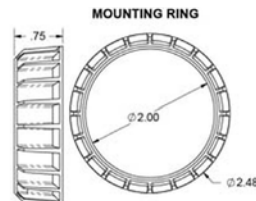
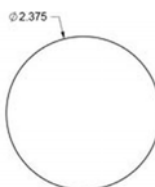
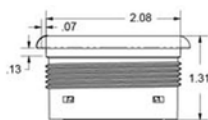

Part Number

97322

TEMP GAUGE

STORAGE BAG

### STORAGE BAG



Part Number
96258

POUCH

### POUCH



Part Number
50

DOCUMENT HOLDER

### DOCUMENT HOLDER

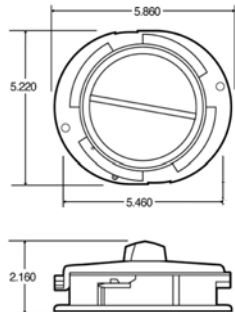

Part Number
97960

GRAY LID

### DOCUMENT HOLDER, GRAY LID

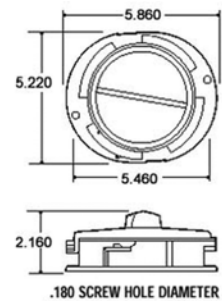

Part Number
97799



## CABLE CLAMP REPAIR, KIT



Part Number  
87845



CABLE CLAMP REPAIR

## ROADSIDE REPAIR KIT, LED



- Contains items needed to replace a malfunctioning S/T/T or M/C lamp with minimal vehicle down-time
- Truck-Lite LED Flex-Lite marker lamps can retrofit many common marker lamp installation with ease, thanks to a simple peel-and-stick adhesive backing
- Includes Truck-Lite Super 44 Series LED S/T/T lamp, with an accommodating PL-3 adapter plug
- Additional wiring accessories include a multi-purpose wire cutter/stripper, high-quality butt-splice connectors and Truck-Lite NYK-77 corrosion-preventive compound

Part Number  
97392



ROADSIDE REPAIR

## ROADSIDE REPAIR KIT, INCANDESCENT



- Contains items needed to replace a malfunctioning S/T/T or M/C lamp with minimal vehicle down-time.
- Includes Truck-Lite 40282R Economy 40 S/T/T Lamp.
- Additional wiring accessories include a multi-purpose wire cutter/stripper, high-quality butt-splice connectors and Truck-Lite NYK-77 corrosion-preventive compound.

Part Number  
97382



ROADSIDE REPAIR

## WIRE CRIMPER



- For use with field-installable terminals 97983 and 97984



Part Number  
77825

## WIRE CRIMPER, CUTTER, & STRIPPER



- Multi-purpose crimp tools



Part Number  
97388

CRIMPER/CUTTER/STRIPPER

# ALARMS & SWITCHES

## BACK-UP ALARMS

Pages 506-509

SERIES	PAGES
Bracket Mount	506-508
Grommet Mount	508
Socket Mount	509

## TURN SIGNAL SWITCHES

Pages 510-516

SERIES	PAGES
Douglas Autotech	510
Ford	510
Freightliner	510
Ford / Freightliner	511
GMC / Euclid / Hitachi	511
Kenworth	511
Mack	511
Navistar	512
Tennant	512
Peterbilt	513
Volvo	513
Volvo / GMC	513
2 Wire Harness	513
4 Wire Harness	514
7 Wire Harness	514
10 Wire Harness	514
2 Position	515
Self-Cancelling	515
Switch Handle	516
ABS Switch	516

## BRACKET MOUNT, 3 SCREW TERMINAL

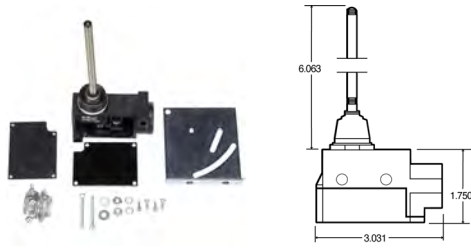

- A water-resistant switch with a 5 amp rating
- Arm operates with a full 360-degree movement
- For use when a back-up light circuit is not available to activate the alarm
- For increased water resistance, an optional 3/8" ID water tight compression fitting is available and will accommodate a 2-conductor round cable
- UL and CSA approved

Part Number	Housing Material	Lamp Connection	Volts	Steam Cleanable	Warranty
92925	Plastic	3 Screw Terminal		No	1 Year
92907	Zinc	3 Screw Terminal	12 24 36		1 Year

## 2 SCREW BRACKET MOUNT, SELF ADJUSTING SOUND REGULATION

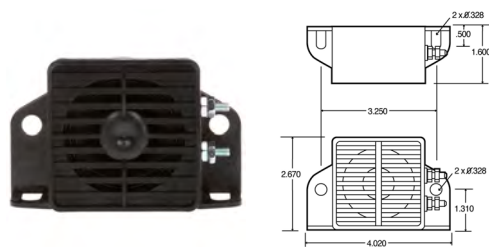

- 92910 specifically designed low sound level alarm for electric powered vehicles
- Compact and extremely dependable back-up alarm
- Solid state electronics
- Steam cleanable
- Meets J994 Type C requirement
- U-L recognized for electric vehicle and forklifts

Part Number	DB Level Min	DB Level Max	Housing Material	Lamp Connection	Volts	Steam Cleanable	Standards Met	Warranty
92911	77	107	Glass Nylon	2 Bolt Terminal	12 24	Yes	J994	2 Year

## 2 SCREW BRACKET MOUNT, SINGLE SOUND REGULATION

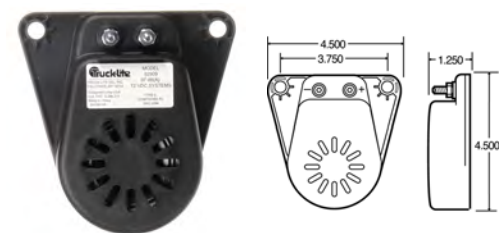

- Single sound back-up alarm for light to medium duty use
- Features epoxy sealed solid state electronics and a rigid PVC plastic housing
- Connections are made with two #8-32 UNC terminal studs
- Meets OSHA, SAE J994, Bureau of Mines and all state regulations

Part Number	DB Level Min	DB Level Max	Housing Material	Lamp Connection	Volts	Steam Cleanable	Standards Met	Warranty
92909	97		PVC	2 Bolt Terminal	12	No	J994	2 Year

## 2 SCREW BRACKET MOUNT, SINGLE SOUND REGULATION, HARDWIRED

- Compact high sound level alarm
- Sealed solid state electronics with polarity protection
- Approximate .5 amp current draw
- Self-resonating circuit board automatically adjusts to environmental conditions to ensure a constant output
- Standard terminal studs are replaced by 12" length, 18 gauge wire leads

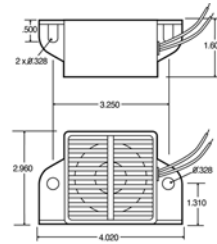

Part Number	DB Level Min	Housing Material	Lamp Connection	Volts	Steam Cleanable	Standards Met	Warranty
92924	107	Glass Nylon	Hardwired	12 24	No	J994	2 Year

## 2 SCREW BRACKET MOUNT, SINGLE SOUND REGULATION, STEAM CLEANABLE

- 92910 specifically designed low sound level alarm for electric powered vehicles
- Compact and extremely dependable back-up alarm
- Solid state electronics
- Steam cleanable
- Meets J994 Type C requirement
- U-L recognized for electric vehicle and forklifts

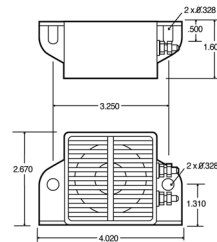

Part Number	DB Level Min	Housing Material	Lamp Connection	Volts	Steam Cleanable	Standards Met	Warranty
92900	97	Glass Nylon	2 Bolt Terminal	12	Yes	J994	2 Year
92901	97	Glass Nylon	2 Bolt Terminal	12 24	Yes	J994	2 Year
92902	102	Glass Nylon	2 Bolt Terminal	12 24	Yes	J994	2 Year
92910	97	Glass Nylon	2 Bolt Terminal	12 24 36 48	Yes	J994	2 Year

## 4 SCREW BRACKET MOUNT, SELF ADJUSTING SOUND REGULATION, STEAM CLEANABLE

- Sealed solid state electronics
- Meets OSHA, SAE J994 Type A-D, Bureau of Mines and all state regulations
- Steam cleanable
- Operating temperatures range from -40°F to 170°F
- UNC terminal studs #8-32

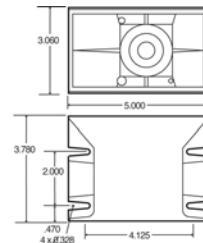

Part Number	DB Level Min	DB Level Max	Housing Material	Lamp Connection	Volts	Steam Cleanable	Standards Met	Warranty
92905	87	112	Glass Nylon	2 Bolt Terminal	12 24 36	Yes	J994	2 Year
92923	97	107	Glass Nylon	3 Bolt Terminal	12 24	Yes	J994	1 Year
92927	87	112	Glass Nylon	3 Bolt Terminal	12 24	Yes	J994	2 Year

## 4 SCREW BRACKET MOUNT, SINGLE SOUND REGULATION, STEAM CLEANABLE

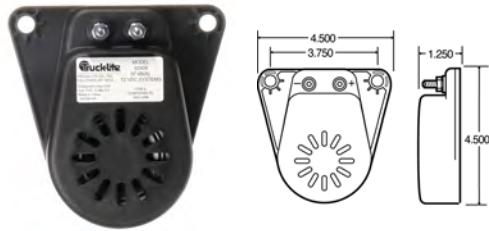

- Sealed solid state electronics
- Meets OSHA, SAE J994 Type A-D, Bureau of Mines and all state regulations
- Steam cleanable
- Operating temperatures range from -40F to +170F
- UNC terminal studs #8-32

Part Number	DB Level Min	Housing Material	Lamp Connection	Volts	Steam Cleanable	Standards Met	Warranty
92903	107	Glass Nylon	2 Bolt Terminal	12 24 36	Yes	J994	2 Year
92904	112	Glass Nylon	2 Bolt Terminal	12 24 36	Yes	J994	2 Year

## GROMMET MOUNT, SELF ADJUSTING SOUND REGULATION, STEAM CLEANABLE

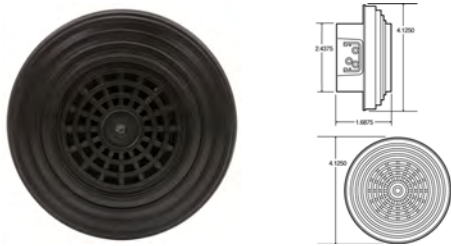

- Features a urethane-filled housing to protect the alarm from moisture, dust and vibration
- Alarm is flush mounted to help protect against road debris, salt and mud
- No additional tools required for installation or replacement
- Manufacturer's 24-month warranty
- Uses industry standard grommets and pigtails
- Steam cleanable
- Voltage spike protected
- Meets OSHA, SAE J994, Bureau of Mines and all state regulations
- Operating temperatures range from -40 F to +170 F

Part Number	DB Level Min	DB Level Max	Housing Material	Lamp Connection	Volts	Steam Cleanable	Standards Met	Warranty
92914	77	97	PC	PL-3	12 24 36 48	Yes	J994	2 Year

## GROMMET MOUNT, SINGLE SOUND REGULATION, STEAM CLEANABLE



- Features a urethane-filled housing to protect the alarm from moisture, dust and vibration
- Alarm is flush mounted to help protect against road debris, salt and mud
- No additional tools required for installation or replacement
- Manufacturer's 24-month warranty
- Uses industry standard grommets and pigtails
- Steam cleanable
- Voltage spike protected
- Meets OSHA, SAE J994, Bureau of Mines and all state regulations
- Operating temperatures range from -40 F to +170 F

Part Number	DB Level Min	Housing Material	Lamp Connection	Volts	Steam Cleanable	Standards Met	Warranty
92916	97	PC	PL-3	12	Yes	J994	2 Year
92918	102	PC	PL-3	12 24	Yes	J994	2 Year

# SIGNAL-STAT, SOCKET MOUNT, SINGLE SOUND REGULATION



- Combination back-up safety device and lamp
- Provides a clear 87dB "beep, beep" when vehicle is put into reverse gear
- 20 watt halogen bulb provides greater light output when vehicle is in reverse
- Perfect for cars, school busses, vans, RVs and light trucks



328D





329D



BACK-UP ALARM

Part Number	DB Level Min	DB Level Max	Housing Material	Lamp Connection	Volts	Steam Cleanable	Warranty
328D	87		Aluminum	Bayonet Base	12	No	2 Year
329D	87		Aluminum	Wedge Base	12	No	2 Year





## DOUGLAS AUTOTECH

	Part Number	OEM Number	Plug Side 2	Replacement Part No.
	960Y101		6 Way Packard Connector 12015345, Packard Connector 2973779, Packard Connector 12015344, Packard Connector 12015987, Packard Connector 12047781	49916, 49916A
	962Y102		6 Way Packard Connector 06288700, Packard Connector 2973778, Packard Connector 08905650	50118, 50118A

## FORD



	Part Number	OEM Number	Plug Side 2	Replacement Part No.
	90251		Ford 14 Way Connector, Packard Connector 12015345	F7HT-13B302-DA, F6HT-13B302-AC, F8HT-13B302-BA
	915Y128		6 Pin Ford Connector, 2 Position .180 Bullet Terminal	F0HS13B302BA

## FREIGHTLINER

	Part Number	OEM Number	Plug Side 2	Replacement Part No.
	90251Y103		Ford 14 Way Connector, Packard Connector 12015345	A06-32389-000
	90251Y103-3		Ford 14 Way Connector, Packard Connector 12015345	A06-32389-000
	915Y119		6 Pin Ford Connector, 2 Position .180 Bullet Terminal	E8HS13B302AA
	915Y113		6 Way Packard Connector 12015345, Packard Connector 12047781, Packard Connector 12015987, Packard Connector 2973778	A06-13867-002, A06-17126-000



## FORD / FREIGHTLINER

	Part Number	OEM Number	Plug Side 2	Replacement Part No.
	900Y180		6 Pin Ford Connector	F0HZ-13441-E, F0HT13B302AB
	900Y170		6 Pin Ford Connector	
	900Y179		6 Pin Ford Connector	



FORD / FREIGHTLINER

## GMC / EUCLID / HITACHI

	Part Number	OEM Number	Plug Side 2	Replacement Part No.
	900Y166		8 Blade Connector	15500336, E4071125, E4071126

GMC / EUCLID / HITACHI

## KENWORTH

	Part Number	OEM Number	Plug Side 2	Replacement Part No.
	900Y209		6 Blade Packard Connector 6288700	K301D182
	915Y103		Packard Connector 6288700, Packard Connector 2984883	18500D044, K301D230











KENWORTH

## MACK

	Part Number	OEM Number	Plug Side 2	Replacement Part No.
	900Y73		8 Blade Packard Connector 2969789	1MR2201P2, 1MR2201P1, 1MR3412P2, 1MR3412P1

MACK



## NAVISTAR

	Part Number	OEM Number	Plug Side 2	Replacement Part No.
	900Y114		6 Blade Packard Connector 6288700	775863C93
	900Y206		Packard Connector 6288700	1663595C91
	960Y100		6 Way Packard Connector 12015345, Packard Connector 2973779, Packard Connector 12015344, Packard Connector 12015987, Packard Connector 12047781	2042616C91, 3566945C91
	961Y100		6 Way Packard Connector 12015345, Packard Connector 2973779, Packard Connector 12015344, Packard Connector 12015987, Packard Connector 12047781	2042615C91, 3566944C91
	962Y100		6 Way Packard Connector 06288700, Packard Connector 2973778, Packard Connector 02973778, Packard Connector 08905650	2002874C91, 3566935C91
	962Y101		6 Way Packard Connector 06288700, Packard Connector 2973778, Packard Connector 08905650	2034257C91, 3566941C91
	963Y100		6 Way Packard Connector 12015345, Packard Connector 12047781, Packard Connector 12015987, Packard Connector 2973778	2002875C91, 3566936C91
	963Y101		6 Way Packard Connector 12015345, Packard Connector 2973779, Packard Connector 12015344, Packard Connector 12015987, Packard Connector 12047781	2007932C91, 3566939C91
	963Y102		6 Way Packard Connector 12015345, Packard Connector 12047781, Packard Connector 12015987, Packard Connector 2973778	2042614C91, 3566943C91
	964Y100		6 Way Packard Connector 12015345, Packard Connector 2973779, Packard Connector 12015344, Packard Connector 12015987, Packard Connector 12047781	2042613C91, 3566942C91

## TENNANT



	Part Number	OEM Number	Plug Side 2	Replacement Part No.
	900Y205		Stripped End	

## PETERBILT

	Part Number	OEM Number	Plug Side 2	Replacement Part No.
	915Y104		Packard Connector 2973890, Packard Connector 2973385	16-03827
	915Y114		Packard Connector 6288700, Packard Connector 2984883	16-04415
	915Y124		Packard Connector 6288700, Packard Connector 2984883	16-06432



PETERBILT

## VOLVO

	Part Number	OEM Number	Plug Side 2	Replacement Part No.
	900Y129		6 Way Packard Connector 2977044	84401-0005
	915Y105		Packard Connector 2977044	84401-3203

VOLVO

## VOLVO / GMC

	Part Number	OEM Number	Plug Side 2	Replacement Part No.
	915Y116		Packard Connector 2977044	3081534, 3081534
	915Y117		Packard Connector 2977044	3081533, 3081533

VOLVO / GMC

## TURN SIGNAL SWITCH, 2 WIRE HARNESS



	Part Number	Plug Side 2
	102	Stripped End

- Illuminated knob
- Meets SAE specifications
- Mounts through 5/8" diameter hole in dashboard
- Two wire connection
- Single pole normally open circuit
- 20 amps @ 12 VDC

2 WIRE HARNESS

## TURN SIGNAL SWITCH, 4 WIRE HARNESS

4 WIRE HARNESS

	Part Number	Plug Side 2
	902	Stripped End
	903	Stripped End

- 4 wire harness
- Only used in conjunction with single function turn signal lamps
- For automotive or agricultural applications
- Pilot light for turn signal and hazard warning
- Recommended flasher 250 series (not included)
- Can be used for 24 volt applications by changing pilot bulb and flasher (263-4)

## TURN SIGNAL SWITCH, 7 WIRE HARNESS

7 WIRE HARNESS

	Part Number	Plug Side 2
	900	Stripped End
	901	Stripped End
	920	Stripped End

- 7 wire harness
- Pilot light for turn signal and hazard warning
- 10 bulb capacity for hazard warning, 5 bulbs per side for turn signal flashing
- Recommended flasher 263 (not included)
- Can be used for 24 volt applications by changing pilot bulb and flasher (263-4)
- Brake overrides hazard function when brakes are applied (920)

## TURN SIGNAL SWITCH, 7 WIRE HARNESS

7 WIRE HARNESS

	Part Number	Plug Side 2
	910	Stripped End

- 7 wire harness
- Pilot light for turn signal and hazard warning
- 16 bulb capacity for hazard warning, 8 bulbs per side for turn signal flashing
- Recommended flasher for 6 to 12 lamps - 252 (not included)
- Recommended flasher for 12 to 16 lamps - 183D (not included)
- Recommended flasher for 16 to 20 lamps 283 (not include)
- Recommended switch for trucks pulling double or triple trailers and for vehicles that flash their hazard warning lamps regularly, or for prolonged periods of time

## TURN SIGNAL SWITCH, 10 WIRE HARNESS

10 WIRE HARNESS

	Part Number	Plug Side 2
	905	Stripped End, 5 Pin Connector

- 10 wire harness with relay
- Signal arm features built-in push button high/low beam selector switch
- 10 bulb capacity for hazard warning, 5 bulbs per side for signal flashing
- Recommended flasher 262 (not included)

## TURN SIGNAL SWITCH, 2 POSITION

	Part Number	Plug Side 2
	131	Stripped End

- 2 Position - Off-On
- Includes weather proof boot
- 10 amps @ 6 and 12 VDC application

2 POSITION

## TURN SIGNAL SWITCH, SELF CANCELLING

	Part Number	Plug Side 2
	91002	6 Blade Packard Connector 6288700

- Surpasses SAE J589 and J910 standards for turn and hazard functions
- Improved light weight, housing and handle
- Capable of flashing 18 lamps in hazard mode (9 lamps per side for turn signal flashing)
- Features a sealed boot to eliminate dust intrusion
- Includes self-canceling feature
- 962 features a lift-to-dim/flash-to-pass

SELF CANCELLING

## TURN SIGNAL SWITCH, SELF CANCELLING, 2 SPEED

	Part Number	Plug Side 2
	91150	6 Way Packard Connector, Packard Connector 12047781

- Surpasses SAE J589 and J910 standards for turn and hazard functions
- Improved, light weight, nylon housing and handle
- Capable of flashing 16 lamps in hazard mode (8 lamps per side for turn signal flashing)
- 960 wiper options include 5 speed intermittent, two speed (hi/low) or washer function
- 961 wiper option includes 2 speeds (hi/low)
- Improved design eliminates premature breakage and component wear
- Feature Lift-to-Dim and Flash-to-Pass options
- Brake overrides hazard function lights when brake pedal is depressed

SELF CANCELLING



## TURN SIGNAL SWITCH, SELF CANCELLING, 7 SPEED

	Part Number	Plug Side 2
	91250	6 Way Packard Connector, Packard Connector 12047781

- Surpasses SAE J589 and J910 standards for turn and hazard functions
- Improved, light weight, nylon housing and handle
- Capable of flashing 16 lamps in hazard mode (8 lamps per side for turn signal flashing)
- 960 wiper options include 5 speed intermittent, two speed (hi/low) or washer function
- 961 wiper option includes 2 speeds (hi/low)
- Improved design eliminates premature breakage and component wear
- Feature Lift-to-Dim and Flash-to-Pass options
- Brake overrides hazard function lights when brake pedal is depressed

SELF CANCELLING

## SWITCH HANDLE

	Part Number	Plug Side 2
	9191	Connector 03-06-1011
	9196	

## ABS SWITCH

	Part Number	Plug Side 2
	50889	Blunt Cut

- Ensures that the full capacity of the shared 'Blue' circuit is available to the ABS when vehicle is moving
- Ensures that accessory leads are "turned off"
- Two 12 gauge 24" wires

# Looking for even more product information?

Visit [truck-lite.com](http://truck-lite.com)



**Powerful Search**



**360° Product Images**



**Easy-To-Find Replacement Parts**

# MERCHANDISING



**DISPLAY RACKS & ACCESSORIES**

**Pages 520-523**

**LIGHTED DISPLAYS**

**Pages 524-528**

**SHOP FLOOR CABINET**

**Pages 529**

GONDOLA RACK

### PEGBOARD GONDOLA RACK, WHITE



Part Number	H x W x D
97020	54" H x 48" W x 18.5" D



### PEGBOARD GONDOLA RACK, BLACK



Part Number	H x W x D
97020B	54" H x 48" W x 18.5" D



GONDOLA RACK

### SLAT GONDOLA RACK, WHITE



Part Number	H x W x D
97920	54" H x 48" W x 18.5" D



### SLAT GONDOLA RACK, BLACK



Part Number	H x W x D
97920B	54" H x 48" W x 18.5" D



PEGBOARD END CAP, WHITE



Part Number	H x W x D
98020	54" H x 24" W x 14" D

PEGBOARD END CAP, BLACK

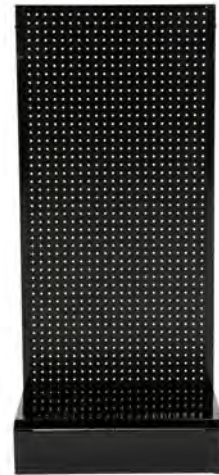

Part Number	H x W x D
98020B	54" H x 24" W x 14" D

END CAP

DISPLAY HEADERS



Part Number	Description
L4HEADER	4' Header



Part Number	Description
LENDCAPHEADER	2' End cap header

L4HEADER



LENDCAPHEADER



HEADERS

HOOKS & PEGS

### PEGBOARD HOOKS



Part Number	H x W x D
97022	1.19" H x 1.31" W x 7" D

### SLAT WALL HOOK



Part Number	H x W x D
97882	3.25" H x 1" W x 6.25" D

BASKET KIT

### PEGBOARD BASKET, KIT

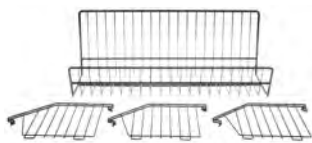

96198 PEG HOOK

- Aesthetically pleasing, high-quality baskets
- Versatile configuration for customized product display



**KIT INCLUDES:**

- 1 basket
- 3 basket dividers (96197)
- 2 peg hooks (96198)

Part Number	H x W x D	Replacement Parts
96199	10.88" H x 8.88" W x 23.75" D	96197 basket divider, 96198 peg hook

BASKET KIT

### SLAT WALL BASKET, KIT

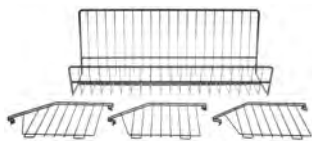

97883 SLAT WALL BRACKET

- Aesthetically pleasing, high-quality baskets
- Versatile configuration for customized product display



**KIT INCLUDES:**

- 1 basket
- 3 basket dividers (96197)
- 2 slat wall brackets (97883)

Part Number	H x W x D	Replacement Parts
98000	8.88" H x 23.75" W x 8.51" D	96197 basket divider, 97883 slat wall bracket

END CAP SHELF

### END CAP SHELF

**FOR USE WITH PEGBOARD END CAPS**



- 90020 & 98020B



FRONT



SIDE

Part Number	H x W x D
98021	1.5" H x 24" W x 10" D
98022	1.5" H x 24" W x 12" D

## PRODUCT LABEL BUNDLES

- Cards have adhesive backing ideal for use on bin boxes
- Can be used with card clip (part# 97029) on front of baskets

Part Number	H x W x D
P340	1.75" H x 3.6" W
P440	2.13" H x 5.0" W



BASKET CARDS

## BASKET CARD PLASTIC CLIPS

- Display interchangeable product labels easily on Truck-Lite's product baskets and bins

Part Number	H x W x D
97029	2" H x 5" W



PLASTIC CLIPS

## BIN BOXES

- Easily organizes parts on a countertop or gondola

Part Number	H x W x D
97140	Small bin box (12"L x 4"W x 4.5" H)
97141	Medium bin box (12"L x 6"W x 4.5" H)
97142	Large bin box (12"L x 8"W x 4.5"H)



BIN BOXES

## VINYL BANNER

Part Number	H x W x D
L48SM	2' x 3'



BANNER

LIGHTED MERCH DISPLAY

## LED DISPLAYS, MULTIPLE LIGHTS



**97377 - TRUCK-LITE LED LIGHTING DISPLAY**

**97376 - SIGNAL-STAT LED LIGHTING DISPLAY**

- Display bases hang on a wall or gondola and can stand on a counter, shelf, or window exhibit
- All units have individually contained power supplies
- Sleek, clean, professional look to assist in product sales

Part Number	WxH	Included Lights
97377	24.25" H x 39.2" W	33250R, 33275Y, 36105R, 36110R, 36100Y, 36203Y, 36203R, 60425Y, 15205, 36140C, 33210C, 44281Y, 60421Y, 44302R, 66250R, 44350C, 66205C, 15250R, 19250Y, 21275Y, 30275R, 30270R, 30250Y, 10275R, 10385R, 10250Y
97482	24.25" H x 39.2" W	SS4558, SS4550A, SS4058A, SS6053, SS4050, SS6051A, SS4063C, SS6058, SS1560, SS1960A, SS2660, SS2150A, SS3050, SS3053A, SS3058, SS1053, SS1058A, SS1051

DISPLAY INSERT

## LED DISPLAYS, MULTIPLE LIGHTS, INSERTS



**97483 - TRUCK-LITE LED LIGHTING DISPLAY INSERT**

**97482 - SIGNAL-STAT LED LIGHTING DISPLAY INSERT**

Part Number	WxH	Included Lights
97483	16.73" W x 34.42" H	33050R, 33080Y, 33203R, 36115Y, 36105R, 36203Y, 36203R, 36110R, 36100Y, 44281Y, 44302R, 44350C, 15250R, 19250Y, 21275Y, 15041, 36042C, 60425Y, 33010C, 60421Y, 66250R, 66205C, 30275R, 30270R, 30250Y, 10275R, 10385R, 10250Y
97376	16.73" W x 34.42" H	4558, 4058A, 4050, 4063C, 1560, 1960A, 2660, 2150A, 4550A, 6053, 6051A, 6058, 3050, 3053A, 3058, 1053, 1058A, 1051

# LED DISPLAYS, HEADLIGHTS



**97381 - 7" ROUND LED HEADLIGHT DISPLAY**



**97383 - 4" X 6" LED HEADLIGHT DISPLAY**



**97405 - 5" X 7" LED HEADLIGHT DISPLAY**

- All units have individually contained power supplies
- Sleek, clean, professional look to assist in product sales
- Interchangeable lighted panels

Part Number	WxH	Included Lights
97381	24.25" H x 17" W	27270C, 27275C
97383	24.25" H x 17" W	27645C, 27640C
97405	24.25" H x 17" W	27450C

LIGHTED MERCH DISPLAY

# LED DISPLAYS, HEADLIGHTS, INSERT



**97487 - 7" ROUND LED HEADLIGHT DISPLAY INSERT**



**97488 - 4" X 6" LED HEADLIGHT DISPLAY INSERT**



**97489 - 5" X 7" LED HEADLIGHT DISPLAY INSERT**

Part Number	WxH	Included Lights
97487	16.73" H x 12.23" W	27270C, 27275C
97488	16.73" H x 12.23" W	27645C, 27640C
97489	16.73" H x 12.23" W	27450C

DISPLAY INSERT

## LED DISPLAYS, WORK LIGHTS

LIGHTED MERCH DISPLAY



- All units have individually contained power supplies
- Sleek, clean, professional look to assist in product sales
- Interchangeable lighted panels



Part Number	WxH	Included Lights
97378	24.25" H x 17" W	81500, SS8160, SS8140, SS8180

## LED DISPLAYS, WORK LIGHTS, INSERT

DISPLAY INSERT



Part Number	WxH	Included Lights
97484	16.73" H x 12.23" W	81500, SS8160, SS8140, SS8180

## LED DISPLAYS, MARKER/CLEARANCE, LICENSE LIGHT

LIGHTED MERCH DISPLAY



- All units have individually contained power supplies
- Sleek, clean, professional look to assist in product sales
- Interchangeable lighted panels



Part Number	WxH	Included Lights
97380	24.25" H x 17" W	33250R, 33250Y, 33275R, 33275Y, 33210C, 33203R, 33260B, 33260G, 33260C, 33260PR, 33260R, 36105R, 36115Y, 36100Y, 36110R, 36203R, 36203Y, 36140C, 36145C



## LED DISPLAYS, MARKER/CLEARANCE & LICENSE LIGHT, INSERT



Part Number	WxH	Included Lights
97486	16.73" H x 12.23" W	33250R, 33250Y, 33275R, 33275Y, 33210C, 33203R, 33260B, 33260G, 33260C, 33260PR, 33260R, 36105R, 36115Y, 36100Y, 36110R, 36203R, 36203Y, 36140C, 36145C

## LED DISPLAYS, STOP/TURN/TAIL



- All units have individually contained power supplies
- Sleek, clean, professional look to assist in product sales
- Interchangeable lighted panels



Part Number	WxH	Included Lights
97379	24.25" H x 17" W	SS4058, SS4050, 44302R

## LED DISPLAYS, STOP/TURN/TAIL, INSERT



Part Number	WxH	Included Lights
97485	16.73" H x 12.23" W	SS4058, SS4050, 44302R

DISPLAY BASE

## LED DISPLAYS, DISPLAY BASE

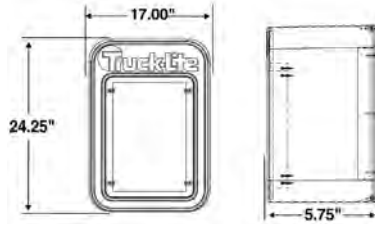

- Display base hangs on a wall or gondola and can stand on a counter, shelf, or window exhibit



**WORKS WITH THESE LIGHTING INSERTS:**

- 97487
- 97488
- 97489
- 97484
- 97486
- 97485

Part Number	WxH
97408	24.25" H x 17" W

DISPLAY BASE

## LED DISPLAYS, DISPLAY BASE , SIGNAL-STAT LED VALUE LINE

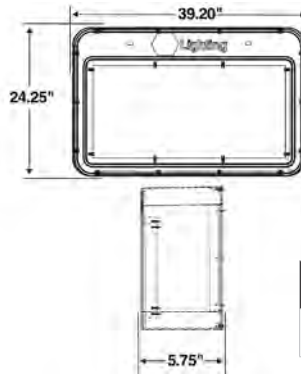

- Display base hangs on a wall or gondola and can stand on a counter, shelf, or window exhibit



**WORKS WITH THESE LIGHTING INSERTS:**

- 97482

Part Number	WxH
97406	24.25" H x 39.2" W

DISPLAY BASE

## LED DISPLAYS, DISPLAY BASE , LED PREMIUM LINE

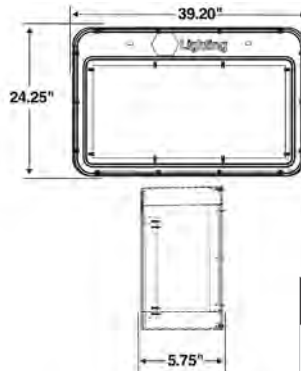

- Display base hangs on a wall or gondola and can stand on a counter, shelf, or window exhibit



**WORKS WITH THESE LIGHTING INSERTS:**

- 97483

Part Number	WxH
97480	24.25" H x 39.2" W

# SHOP FLOOR CABINET, KIT

- 24-compartment cabinet
- Organizes cluttered shelf inventory
- Part selection covers 75% of common repair work
- Easy to manage and fulfill replacement orders
- Great assortment of lamps for standard repair and inspection stations
- To customize the cabinet, please contact your local Truck-Lite regional manager

**KIT INCLUDES:**

- 47 (10 ea)
- 10202R/Y (10 ea)
- 10700 (10 ea)
- 15200R/Y (10 ea)
- 15208 (10 ea)
- 19200R/Y (10 ea)
- 19206 (10 ea)
- 19721 (10 ea)
- 30200R/Y (10 ea)
- 30700 (10 ea)
- 40204 (5 ea)
- 40282R (10 ea)
- 40700 (10 ea)
- 60202R (10 ea)
- 60204C (5 ea)
- 60215Y (6 ea)
- 60700 (10 ea)
- 80360 (6 ea)
- 94902 (10 ea)
- 94993 (10 ea)



SHOP FLOOR CABINET

Part Number	H x W x D	Description	Replacement Parts
55653	42" H x 33.88" W x 11.88" D	Cabinet with inventory	47, 10202R/Y, 10700, 15200R/Y, 15208, 19200R/Y, 19206, 19721, 30200R/Y, 30700, 40204, 40282R, 40700, 60202R, 60204C, 60215Y, 60700, 80360, 94902, 94993
55650	42" H x 33.88" W x 11.88" D	Cabinet only	

# **TECHNICAL INFORMATION & REFERENCE**

**FAQS**

**Pages 532-533**

**FEDERAL LIGHTING REGULATIONS**

**Pages 534-543**

**WARRANTY & PROCEDURES**

**Pages 544-548**

**PRODUCT INTERCHANGE**

**Pages 549-560**

**NUMERICAL INDEX**

**Pages 561-584**

## Frequently Asked Questions

### What lights do I need?

Check the specific vehicle requirements or contact Truck-Lite Technical Support. Note that states cannot require anything different than what is in FMVSS-108; however, states can add regulations. Contact Truck-Lite for special situations.

### The vehicle has everything needed for FMVSS-108, so why did the State Police give me a ticket?

States can regulate anything not covered by FMVSS-108, such as any accessory lamps or lamps that are not mandated by FMVSS-108. Generally, the problem is in these areas. Sometimes, however, it can simply be a mistake. In that case, Truck-Lite can often write a letter to clarify the issue.

### What are combination marker/clearance lights, and how do I mount them?

A combination marker/clearance light is one light doing the work of two. It must be at a 45-degree angle (on corners) to be legal. It needs to be marked "PC" in the lens code. For further information, contact Truck-Lite.

### How hard should I tighten down (torque) plastic lights or devices?

Over-torqueing will generally cause cracking or distortion. Use the torque specifications provided by the manufacturer. A marker light will generally be about 8 to 20 inch-lbs., but a good rule of thumb is to use the minimum torque necessary to secure the device.

### Are heavy-duty harnesses worth the extra cost?

We think so! Heavy-duty harnesses provide an independent (secure) ground and less voltage drop and are completely sealed to avoid corrosion. We don't recommend taking any chances when it comes to safety and efficiency.

### What is the 12 Square Inch Rule?

On December 1, 1991, the National Highway Traffic Safety Administration (NHTSA) made effective the final ruling regarding the 12 Square Inch Rule. This ruling requires that the total luminous lens area for a stop and turn light must not be less than 75 centimeters squared (11.625 square inches) when used on vehicles over 80 inches wide. It must be noted that a reflex reflector ring cannot be counted as square inch lens area. When the reflex ring is subtracted from the total 12-inch lens, it leaves less than the 12 square inches required.

### Is it illegal or non-compliant to use LED lamps that have clear lenses, but produce red or yellow output?

No. There is nothing illegal or non-compliant about having red or yellow LEDs behind clear lenses. When illuminated, the effective colors of the lights are red or yellow, which are approved colors of SAE J578c requirements. Clear lenses are legally approved for SAE J578c regulations as well. For a specific statement of the requirements, please review the NHTSA regulations charts.

## Frequently Asked Questions

### **Is it okay to mount a lamp at an angle that isn't "square" on the vehicle?**

The legality of a lamp's positioning varies on a case-by-case basis, often requiring a special lab test for each position. However, Truck-Lite products specifically state the proper mounting position(s), so you can be sure that your lamp and its positioning are fully compliant with all regulations.

---

### **Can I ever use the Model 40 with reflex reflector ring legally?**

Yes, the Model 40 with reflex reflector ring can be used in the following situations:

- On any vehicle under 80" wide
  - As an "extra" light on over 80" (reflex is legal)
  - On vehicles made in 1991 or earlier, when installed by the vehicle's owner (although most states enforce the federal requirement)
- 

### **Is SAE or DOT lettering required on lights?**

Lettering is not required by NHTSA (FMVSS-108) except for headlights and conspicuity tape. The Federal Motor Carrier Safety manual mentions that some lights should be marked SAE but this is not enforced. Truck-Lite marks all their lights with SAE and/or DOT markings, where applicable.

---

### **Are there any special lighting requirements for vehicles hauling flammable or explosive materials?**

There are no special federal requirements, as FMVSS-108 covers all over-the-road vehicles. Some states or municipalities have regulations, but these cannot supersede FMVSS-108 – they can only add to it. Truck-Lite's lights and wiring systems have been tested to all known standards and certifications. Reports are available from Truck-Lite, if necessary.

---

### **FMVSS-108 says that some lights must be mounted "as high as practicable." What is practicable?**

NHTSA has stated that the vehicle manufacturer has the responsibility to choose the best mounting location "in light of the particular design/configuration of the vehicle involved" and they will not contest it unless it is "clearly erroneous." Recently, Canada has started to strictly enforce the word practicable as meaning "capable of being done." In the case of side markers, this means not more than six inches from the edge of the vehicle.

---

### **My customer wants to use a light for a side turn that isn't listed for that function. Is this OK, seeing as how side turns aren't required anyway?**

Be careful that it doesn't violate some state laws regarding color or location. If it is also used as a side marker, the function must be listed on the lens code.

---

### **My customer wants to add some auxiliary lights (i.e. illuminated signs, deceleration lights, decorative lights). Are these legal?**

Yes, provided they do not render inoperative any device in compliance with FMVSS-108, negatively affect the performance of required equipment or create confusion or misunderstanding of lighting signals. Feel free to contact Truck-Lite if you have any questions!

# Trailer Equipment Location Requirements

To read, please use the chart on the following pages.

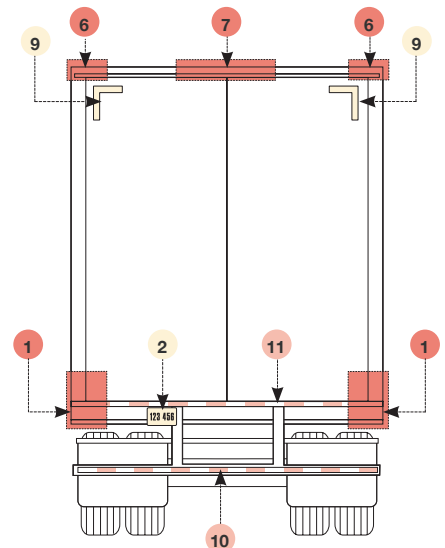
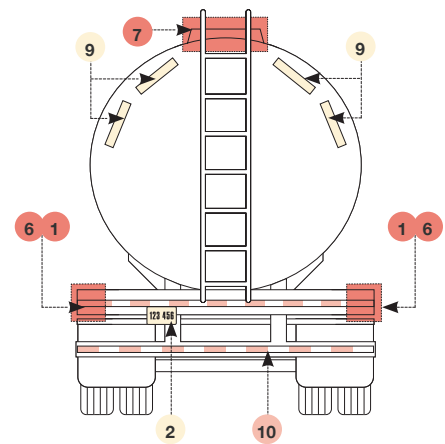
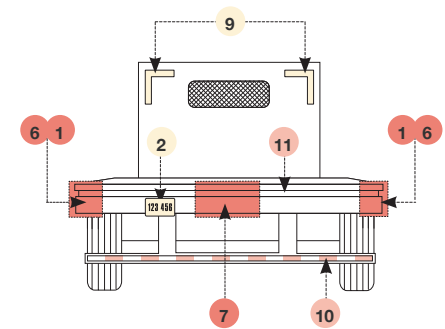
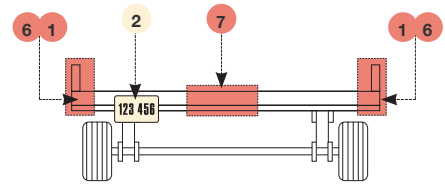
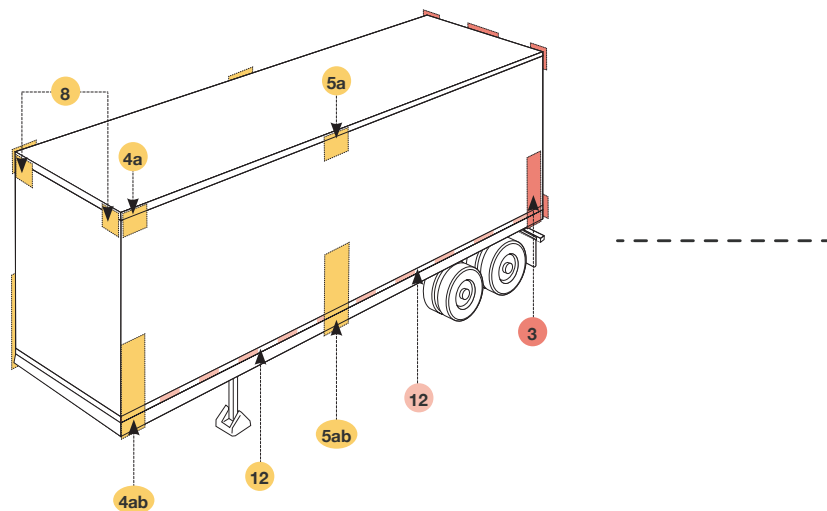
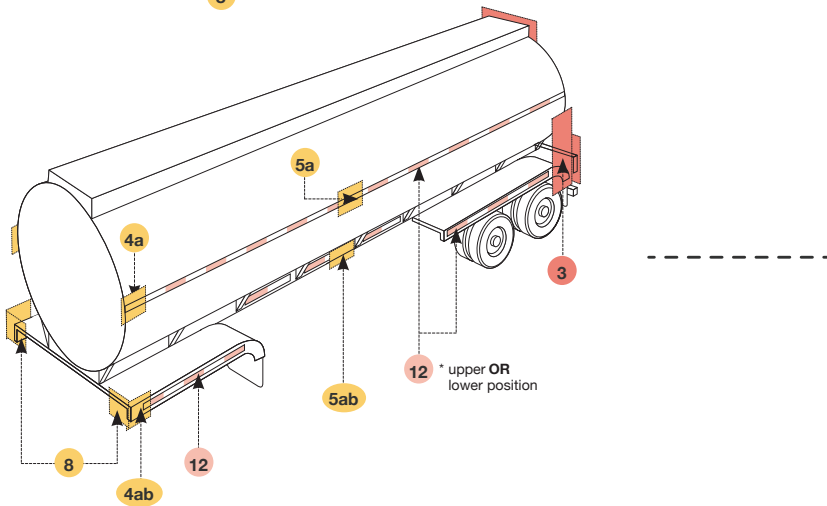
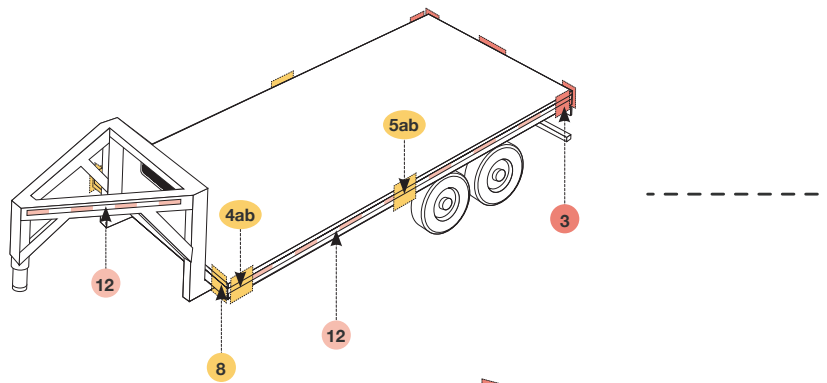
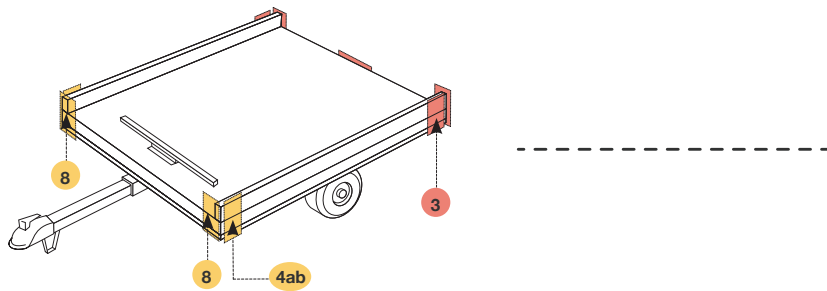



To read, please use the chart on the following pages.

# Trailer Equipment Location Requirements

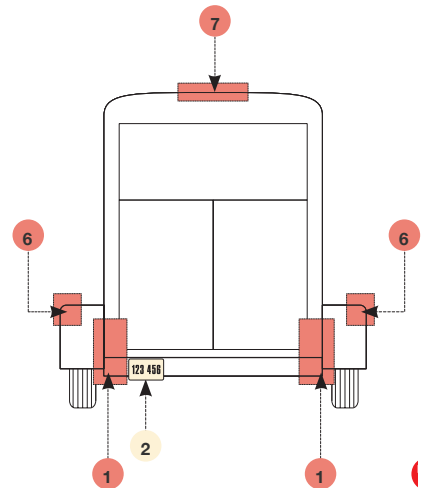
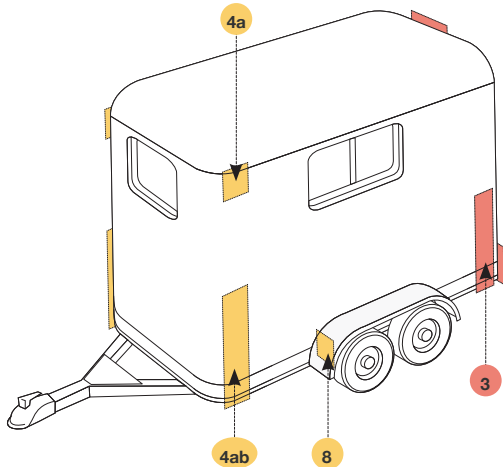
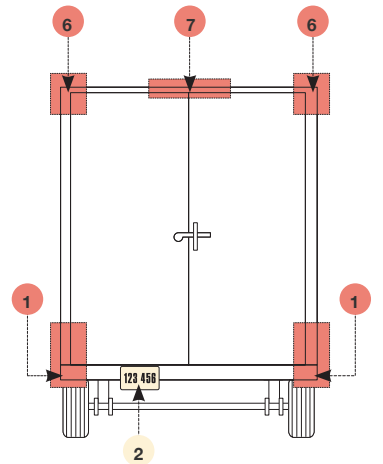
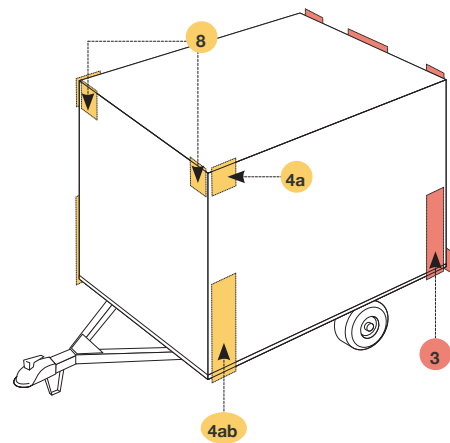
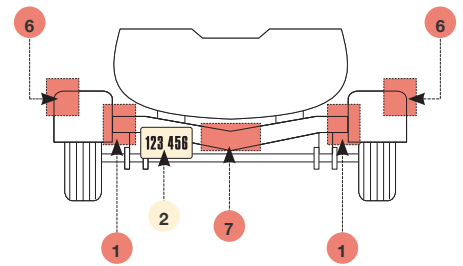
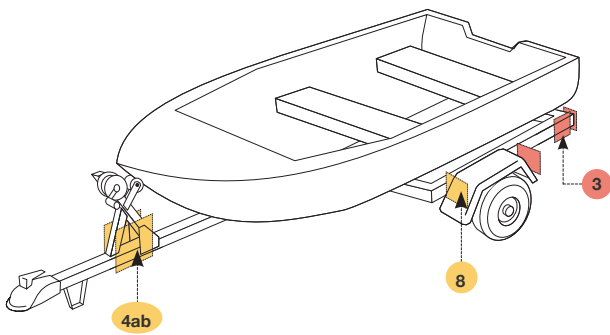
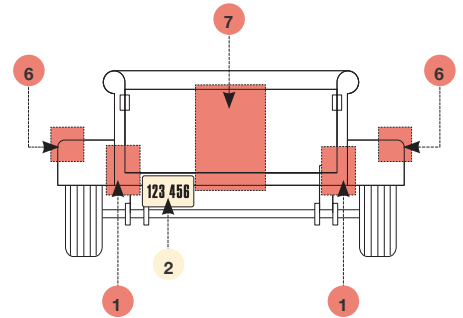
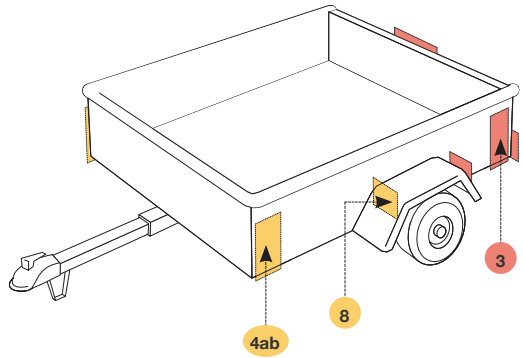

# BASIC EQUIPMENT REQUIRED ON ALL TRAILERS

Trailer Equipment Locations | All Trailers Over 80 Inches



\* Photometrically certified at installation angle

## Description & Mandatory Requirements

	Equipment	SAE Lens Coding	Function	Quantity	Location	Height & Height From Ground
<b>1</b>	Tail Lamps	(T)	Indicate vehicle's presence & width	Min. 2	On rear - symmetrical as far apart as practicable	380-1830mm (15-72 in.)
	Stop Lamps	(S)	Indicate breaking	Min. 2	On rear - symmetrical as far apart as practicable	380-1830mm (15-72 in.)
	Rear Turn Sig. Lamp	(I)	Indicate direction of turn	Min. 2	On rear - symmetrical as far apart as practicable	380-2110mm (15-83 in.)
	Rear Reflex Reflectors	(A)	Indicate vehicle's presence & width	Min. 2	On rear - symmetrical as far apart as practicable facing rearward	380-1530mm (15-60 in.)
<b>2</b>	License Plate Lamps	(L)	Illuminates license plate	Min. 1	On the rear - above or at the sides of license plate	No requirements
<b>3</b>	*Rear Side Marker Lamps	(P2, PC* or P3, PC2*)	Front & rear side marker lamps/side reflex reflectors indicate vehicle's presence & length	Min. 2	Each side at rear as far back as practicable	380-1530mm (15-60 in.) no max. for veh. under 2032 mm (80 in.) wide
	Rear Side Reflex Reflectors	(A)	Front & rear side marker lamps/side reflex reflectors indicate vehicle's presence & length	Min. 2	Each side at rear as far back as practicable facing sideways	380-1530mm (15-60 in.)
<b>4</b>	a *Front Side Marker Lamps	(P2, PC* or P3, PC2*)	Front & rear side marker lamps/side reflex reflectors indicate vehicle's presence & length	Min. 2	Each side at front as far forward as practicable	380 mm (15 in.) minimum
	b Front Side Reflex Reflectors	(A)	Front & rear side marker lamps/side reflex reflectors indicate vehicle's presence & length	Min. 2	Each side front as far forward as practicable facing sideways	380-1530mm (15-60 in.)

## Description & Mandatory Requirements

Length 9.1 m (30 ft.) or longer & Width 2032 mm (80 in.) or wider

	Equipment	SAE Lens Coding	Function	Quantity	Location	Height & Height From Ground
<b>5</b>	<b>a</b> Intermediate Side Marker Lamps	(P2 or P3)	Indicates presence of a long vehicle	Min. 2	Each side near center facing sideways	380mm (15 in.) minimum
	<b>b</b> Intermediate Side Reflex Reflectors	(A)		Min. 2	Each side near center facing sideways	380-1530mm (15-60 in.)
<b>6</b>	*Rear Clearance Lamps	(P2, PC* or P3, PC2*)	Show vehicle's width MAY NOT be combined with tail lamps	Min. 2	At widest point-symmetrical on the rear of near the rear facing rearward	As high as practicable may be lower only if ID lamps are at top
	<b>7</b> Rear Identification Lamps	(P2 or P3)	Indicates presence of a wide vehicle	Exactly 3	On the rear-center horizontally spaced-150 mm (6 in.) to 300 mm (12 in.) apart facing rearward	At the top-may be lower if door header narrower than 25 mm
<b>8</b>	*Front Clearance Lamps	(P2, PC* or P3, PC2*)	Show vehicle's width	Min. 2	At widest point-symmetrical on the front or near the front facing forward	As high as practicable

## Description & Mandatory Requirements

Width 2032 mm (80 in.) or wider & GVWR 4536 kg (10,001 lb.) or more

	Conspicuity Treatment	DOC Coding	Quantity	Location	Height	Options
<b>9</b>	Rear Upper Body Markings	DOT-C DOT-C2 DOT-C3 DOT-C4	Exactly 2 pairs of 300 mm long strips	On the rear upper corners facing rearward	At the top	Reflex reflectors (#3) may not be required if they are replaced in their required location with conspicuity treatment.  <b>Optional in Canada:</b>  Rear lower body and side conspicuity also be solid white, solid yellow, or white & yellow.
<b>10</b>	Bumper Bar Markings	DOT-C DOT-C2 DOT-C3 DOT-C4	Continuous	On the rear bumper bar's horizontal element full width of the vehicle facing rearward	No requirement	
<b>11</b>	Rear Lower Body Marking	DOT-C DOT-C2 DOT-C3 DOT-C4	Continuous	On the rear full width of the vehicle facing rearward	As horizontal & as close as practicable to the range of 375mm to 1525 mm from the ground	
<b>12</b>	Side Marking	DOT-C DOT-C2 DOT-C3 DOT-C4	(see location)	Each side-facing sideward continuous, or evenly spaced over minimum of 50% length starts & ends as close to the front & rear of the vehicle as practicable	As horizontal & as close as practicable to the range of 375 mm to 1525 mm from the ground	

# Truck, Bus, MPV Equipment Location Requirements

To read, please use the chart on the following pages.

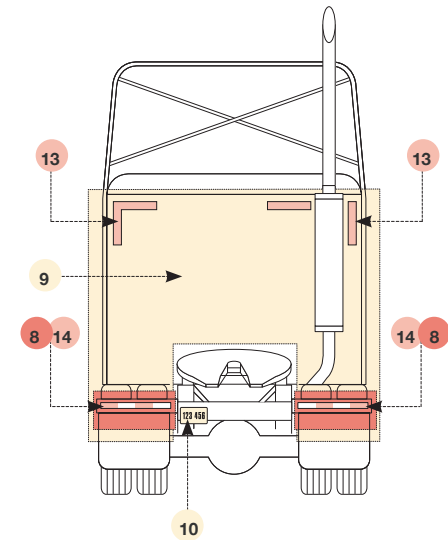
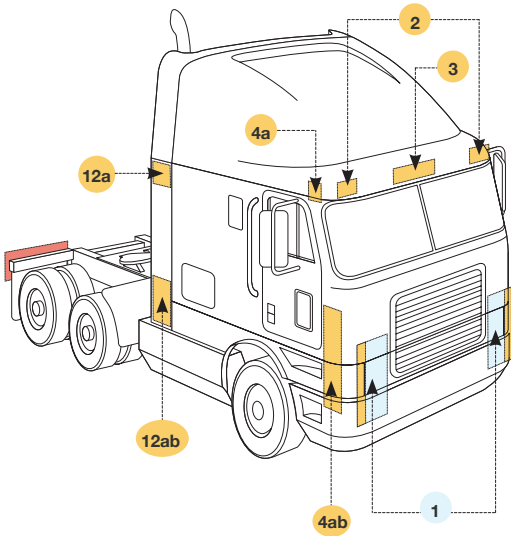
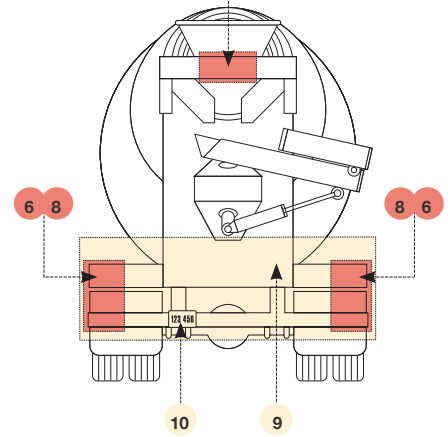
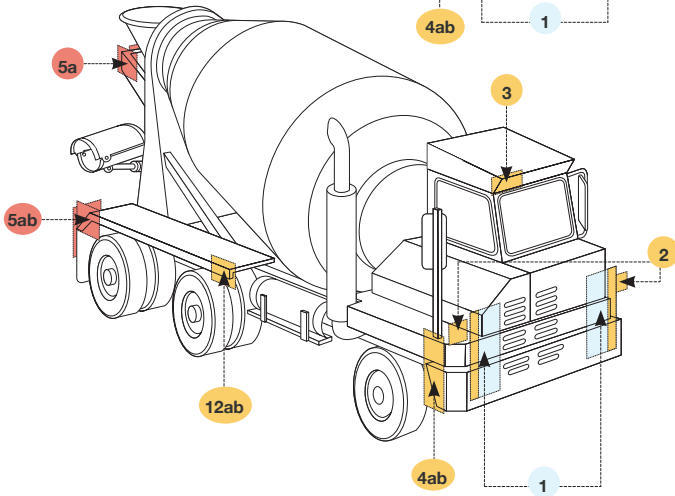
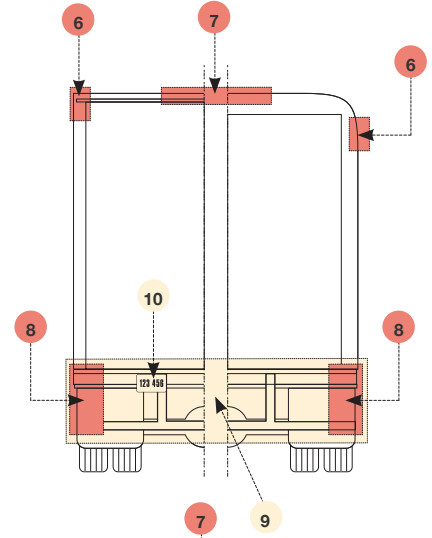
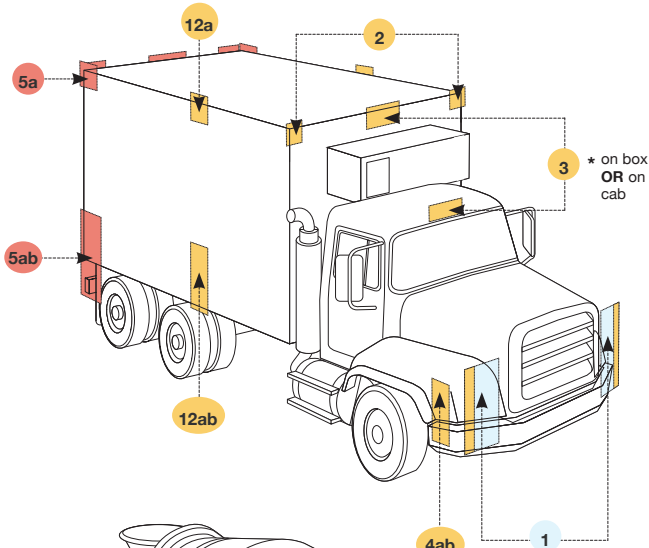

To read, please use the chart on the following pages.

# Truck, Bus, MPV Equipment Location Requirements

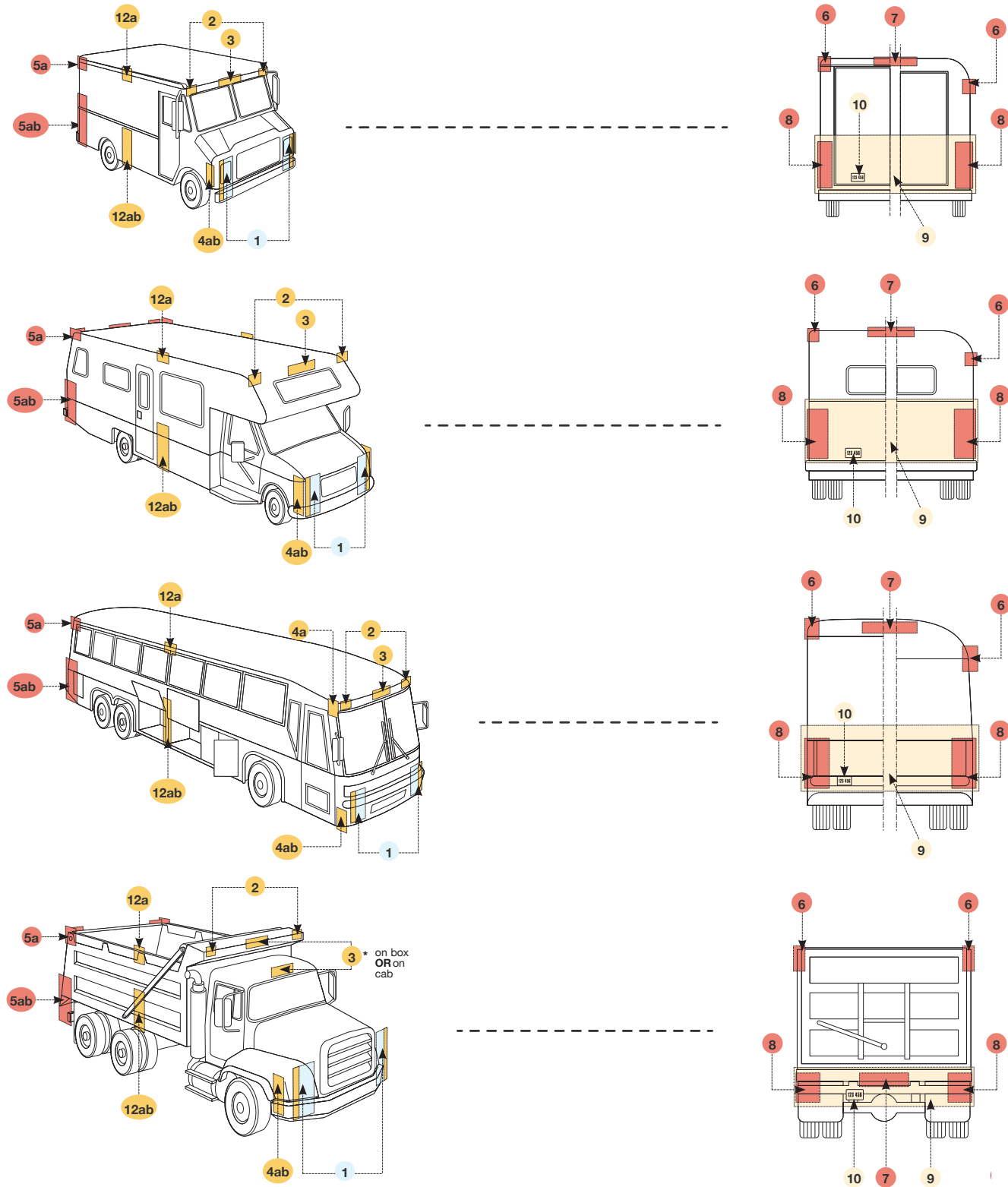

# TRUCK, BUS, MPV EQUIPMENT LOCATION REQUIREMENTS

Trailer Equipment Locations | All Trailers Over 80 Inches



\* Photometrically certified at installation angle

## Description & Mandatory Requirements

	Equipment	SAE Lens Coding	Function	Quantity	Location	Height From Ground
1	Headlamp-Lower Beam	(H, HR)	Forward road illumination, US requires 'DOT' lettering on lens US&Canada -light code required on lens	Min. 2	Front-symmetrical as far apart as practicable if 4 lamp system-outboard or above upper beams	560-1370mm (22-54 in.)
	Headlamps-Upper Beam	(H, HR)	Forward road illumination, US requires 'DOT' lettering on lens US&Canada -light code required on lens	Min. 2	Front-symmetrical if 4 system-inboard or below lower beams	560-1370mm (22-54 in.)
	Parking Lamps	(P)	Indicate parked vehicle vehicles less than 2032 mm wide	Min. 2	Front-symmetrical as far apart as practicable	380-1830mm (15-72 in.)
	Daytime Running Lamps	(Y2)	Indicate in use vehicle Canada- required/US option US requires lettering on lens if not headlamps	Min. 2	Front-symmetrical as far apart as practicable	380mm (15 in.) min. Max. depends on DRL type
2	Front Turn Sig./Hazard Warning lamps	(I)	Indicate direction of turn/identify disabled vehicle	Min. 2	Front-symmetrical as far apart as practicable	380-2110mm (15-83 in.)
	*Front Clearance Lamps	(P2, PC* or P3, PC2*)	Show vehicle's width Vehicles 2032mm wide or wider	Min. 2	At widest point-symmetrical on the front or near the front facing forward	As high as practicable
3	Front Identification Lamps	(P2, or P3)	Indicate presence of a wide vehicle Vehicles 2032mm wide or wider	Exactly 3	On the front-center horizontally space 150 mm (6 in.) to 300 mm (12 in.) apart	As high as practicable or the top of the cab
4	a *Front Side Marker Lamps	(P2, PC* or P3, PC2*)	Front & rear side marker lamps/side reflex reflectors indicate vehicle's presence & length	Min. 2	Each side at front as far forward as practicable	380mm (15 in.) minimum
	b Front Side Reflex Reflectors	(A)	Front & rear side marker lamps/side reflex reflectors indicate vehicle's presence & length	Min. 2	Each side front as far forward as practicable facing sideways	380-1530mm (15-60 in.)

## Description & Mandatory Requirements

	Equipment	SAE Lens Coding	Function	Quantity	Location	Height From Ground
<b>5</b>	a *Rear Side Marker Lamps	(P2, PC* or P3, PC2*)	Front & rear side marker lamps/side reflex reflectors indicate vehicle's presence & length	Min. 2	Each side at rear as far back as practicable	380mm (15 in.) minimum
	b Rear Side Reflex Reflectors	(A)	Front & rear side marker lamps/side reflex reflectors indicate vehicle's presence & length Not required on Truck Tractors	Min. 2	Each side at rear as far back as practicable facing sideward	380-1530mm (15-60 in.)
<b>6</b>	*Rear Clearance Lamps	(P2, PC* or P3, PC2*)	Show vehicle's width MAY NOT be combined with tail lamps Vehicles 2032mm wide or wider Not required on Truck Tractors	Min. 2	At widest point-symmetrical on the rear of rear the rear facing rearward	As high as practicable may be lower only if ID lamps are at top
<b>7</b>	Rear Identification Lamps	(P2 or P3)	Indicates presence of a wide vehicle Vehicles 2032mm wide or wider Not required on Truck Tractors	Exactly 3	On the rear-center horizontally spaced-150 mm (6 in.) to 300 mm (12 in.) apart facing rearward	At the top-may be lower if door header narrower than 25 mm
<b>8</b>	Trail Lamps	(T)	Indicates vehicle's presence and width	Min. 2	Rear-symmetrical as far as practicable	380-1830mm (15-72 in.)
	Stop Lamps	(S)	Indicate braking	Min. 2	Rear-symmetrical as far as practicable	380-1830mm (15-72 in.)
	Rear Turn Sig./Hazard Warning Lamps	(I)	Indicates direction of turn/identify disabled vehicle	Min. 2	Rear-symmetrical as far as practicable	380-1830mm (15-72 in.)
	Rear Reflex Reflectors	(A)	Show vehicle's presence & width	Min. 2	Rear-symmetrical as far as practicable	380-1830mm (15-72 in.)

CONTINUED ON NEXT PAGE

# TRUCK, BUS, MPV EQUIPMENT LOCATION REQUIREMENTS

Trailer Equipment Locations | All Trailers Over 80 Inches



\* Photometrically certified at installation angle

## Description & Mandatory Requirements

Length 9.1 m (30 ft.) or longer & Truck Tractor

	Equipment	SAE Lens Coding	Function	Quantity	Location	Height From Ground
9	Backup Lamp	(R)	Illuminates ground behind the vehicle and alert road users	Min. 1	Rear	No requirement
	License Plate Lamp(s)	(L)	Illuminates license plate	Min. 1	Rear-above or at the sides of license plate	No requirement
12	a Intermediate Side Marker Lamps	(P2 or P3)	Indicate presence of a long vehicle	Min. 2	Each side near center	380mm (15 in.) minimum
	b Intermediate Side Reflex Reflectors	(A)	Indicate presence of a long vehicle	Min. 2	Each side near center facing sideward	380-1530mm (15-60 in.)
	Conspicuity Treatment	DOC Coding	Quantity	Location	Height	Options
13	Rear Upper Body Markings	DOT-C DOT-C2 DOT-C3 DOT-C4	Exactly 2 pairs of 300 mm long strips	Rear upper corners of cab facing rearward	As high as practicable excluding fairings	—
14	Rear Marking	DOT-C DOT-C2 DOT-C3 DOT-C4	Exactly 2 sections of min. 600 mm each	Rear-facing rearward-on fenders, on mud flap brackets, or within 300 mm below the top of mud flaps	As horizontal as practicable and higher than 1525 mm from the ground	If mud flaps not used- on the cab or frame mounted brackets



SAE Device Codes • Letters Indicating Device Functions

A	Reflex reflector
A2	Reflex reflector for use on vehicles 2032mm or more in overall width
A3	Reflex reflector for conspicuity treatment (CT), for use on vehicles 2032mm or more in overall width
A4	Reflex reflector for CT (vehicles > 2032mm in width) - 50mm wide [truck/trailer]
A5	Reflex reflector for CT (vehicles > 2032mm in width) - 75mm wide [truck/trailer]
A6	Reflex reflector for CT (vehicles > 2032mm in width) - 100mm wide [truck/trailer]
A7	Reflex reflector for CT (vehicles > 2032mm in width) - 25mm wide [truck/trailer]
C	Motorcycle auxiliary front lamp
D	Motorcycle and motor-driven cycle turn signal lamp
DL	Distributed lighting system (headlamp)
E	Side turn signal lamp - vehicles 12m or more in length
E2	Side turn signal lamp - vehicles less than 12m in length
EVS1	Siren - interior location
EVS2	Siren - exterior location
EVS3	Siren - under hood location
F	Front fog lamp
F2	Fog tail lamps
G	Truck cargo lamp
H	Sealed beam headlamp
HC	Headlamp center
HG	Discharge forward lighting (headlamp)
HH	Sealed beam headlamp housing
HR	Replaceable bulb headlamp
I	Turn signal lamp spaced greater than 100mm from headlamp
I3	Turn signal lamp spaced from 75mm to less than 100mm from headlamp
I4	Turn signal lamp spaced from 60mm to less than 75mm from headlamp
I5	Turn signal lamp spaced less than 60mm from headlamp
I6	Rear mounted turn signal lamp and front mounted turn signal lamps mounted 100mm or more from the headlamp, for use on vehicles 2032mm or more in overall width
I7	Front mounted turn signal lamp mounted less than 100mm from the headlamp, for use on vehicles 2032mm or more in overall width
J1690	Flasher
K	Front cornering lamp
K2	Rear cornering lamp
L	License plate lamp
M	Motorcycle and motor-driven cycle headlamp - motorcycle type
N	Motorcycle and motor-driven cycle headlamp - moto driven cycle type
O	Spot lamp
P	Parking lamp
P2	Sidemarkers lamp for use on vehicles 2032mm or less in overall width
P3	Clearance, sidemarkers and identification lamp for use on vehicles 2032mm or more in overall width
PC2	Combination clearance and sidemarkers lamp for use on vehicles 2032mm in width or more in overall width
Q	Turn signal operating unit - Class A
QB	Turn Signal operating unit - Class B
QC	Vehicular hazard warning signal operating unit
QD1	Turn signal operating unit for use on vehicles 2032mm in width or more in overall width - Type 1
QD2	Turn signal operating unit for use on vehicles 2032mm in width or more in overall width - Type 2
QE1	Hazard warning operating unit for use on vehicles 2032mm in width or more in overall width - Type 1
QE2	Hazard warning operating unit for use on vehicles 2032mm in width or more in overall width - Type 2
R	Reversing (back-up) lamp
S	Stop lamp
S2	Stop lamp for use on vehicles 2032mm or more in overall width
T	Tail lamp (rear position lamp)
T2	Tail lamp (rear position lamp) for use on vehicles 2032mm or more in overall width
U	Supplemental high-mounted stop and turn signal lamp
U2	High-mounted stop lamp for use on vehicles 2032mm or more in overall width
U3	Center high-mounted stop lamp for passenger cars, light trucks and MPV's
W	Warning lamp for emergency, maintenance and service vehicles
W2	Warning lamp for school buses
W3-1	Optical warning device - Class 1
W3-2	Optical warning device - Class 2
W3-3	Optical warning device - Class 3
W4	Emergency warning device [triangular shape]
W5-1	360° gaseous discharge lamp - Class 1
W5-2	360° gaseous discharge lamp - Class 2
W5-3	360° gaseous discharge lamp - Class 3
X	Adaptive [forward] lighting system
Y	Auxiliary high beam lamp
Y2	Daytime running lamp
Z	Auxiliary low beam lamp

## Cleaning Materials

The use of solvents which are not compatible with polycarbonate will result in the softening, crazing, and/or cracking of the plastic part. This is especially true of polycarbonate lamps & mounting bases which may be under stress in their normal applications.

The following solvents/cleaners are compatible with polycarbonate:

Mild soap and water	Dirtex®
Mineral Spirits	2% Sol. Reg. Joy
Hexane	Heptane
VM & P Naphtha	White Kerosene
Varsol No. 2	Methyl, isopropyl & isobutyl
#1 & #3 denatured	alcohols
alcohol	Lacryl® PCL-2035
Freone TF & TE-35	polycarbonate cleaner
Ethanol	Petroleum Ether/65 degrees C
10% Sol Bon Ami®	boiling point

The following solvents/cleaners **MUST NOT** be used with polycarbonate:

Trichlor	Carbon Tetrachloride	Diversol®
Acetone	Chlorinated Hydrocarbons	Lemon Joy®
Triclene®	Texize-8006, 8129, 8758	(phosphate free)
Methyl Ethyl Keytone	Liquid Cleaner - 8211	Kleenol Plastics
(MEK)	Agitene®	Lestoil®
MIBK	Ajax®	Lysol®
Toluol	All Liquid Detergents	Stanisol Naphtha®
Benzol	Pink Lux® (phosphate	Oils
Gasoline	free)	

Questions as to compatibility of other specific materials should be directed to the manufacturer and/or the Truck-Lite Corporate Laboratory.

## Tips To Prolong Equipment Lighting

- Never use a test probe to pierce wire insulation when troubleshooting lighting complaints. Wicking action takes place which causes moisture to travel along the wire strands and corrode critical connections. If probing a harness or wire is necessary, make sure the puncture is properly sealed.
- To correct voltage problems, discover the real cause. Under-voltage often is caused by poor electrical connections. To correct under-voltage, don't just turn up the voltage — find out what caused the under-voltage problem.
- Many discarded lamps are still in good condition. Play detective when solving lamp problems. First, test with either a meter, power supply, or battery. Our 97100 tester is an excellent tool for this. Then if you desire, open the lens on a discarded lamp and examine the bulb. It will tell you why it failed. For example:
  - A bulb with stretched or broken filaments was subjected to vibration.
  - A yellowish, whitish or bluish glaze on the bulb indicates a rupture in the bulb glass envelope.
  - A dark metallic finish indicates old age.
  - A black, sooty bulb indicates a poor seal in bulb.
 Test all lamps one more time before you discard them. Truck-Lite's warranty department reports that up to 20 percent of all lamps sent back are still in good operating condition. The ones that aren't working can be turned over to your lamp supplier.
- All lamps will live longer if they run cool. Dirt on the lens increases the heat, so keep them as clean as possible. Other people can see your rig, and that is one of the purposes of the lighting system – to be seen. **Certain lighting products generate heat. Care should be taken to avoid contact with flammable materials.**
- Treat the electrical system as you would the chassis. Lubricate sockets, pigtails, battery terminals and connections with NYK 77 "non-conductive" anti-corrosion compound. The purpose of the sealant is to totally encapsulate and protect against corrosion and water.
- Inspect for improper ground connections. This is a major cause of lamp failure, especially when the trailer is used for a ground. When lamps are grounded through the lamp housing, make sure there is a clean connection (i.e., metal-to-metal). Also, a fifth wheel ground strap may be used for added protection on the chassis ground system.
- Look for loose, bare or unsupported wire, and fixtures. Harnesses and wiring should be on the underside of top frame members rather than on the bottom where dirt and road splash collect.
- Always replace wiring, trailer light cables, and harnesses with an equal or heavier gauge of wire than was used in the original specifications. If you don't, you may cause unnecessary problems.
- On older trucks, you should never crank the truck when any lights or accessories are on. Also, never leave markers and hazard lights on when parked against a dock. Melted lenses are a sure sign that the vehicle has been parked against the dock while the lights were on.
- Inspect the grommets that house the lamps. As they age, they eventually will deteriorate from sunlight, ozone and harmful chemicals. New grommets restore shock protection, security and improves appearance.

## Warning Symbols



Lighting products generate heat! Care should be taken to avoid contact with flammable material.

Designed to conform to applicable Federal Safety Standards.  
Meets applicable SAE Standards and US DOT Requirements.



Any unauthorized substitution or modification to products or packaging manufactured or sold by Truck-Lite could cause bodily injury or affect the performance and safe operation of the product. Truck-Lite Co., Inc. shall not be liable for personal injury or property damages caused by unauthorized substitutions or modifications.



Truck-Lite products do not place a person at risk by exposure to chemicals and can be properly disposed of in an approved landfill.



LEDs (Light Emitting Diodes) use less current than incandescent products and may affect the proper operation of other electronic devices or systems on the vehicle. Always confirm proper operations and/or verify the LED Lighting products compatibility with the vehicle manufacturer.

## Limited Warranties & Procedures



Truck-Lite extends a Limited Warranty to the original purchaser that the warranted products defined below are free from defects in workmanship and/or materials only, whereby Truck-Lite will replace any warranted product to the original consumer/purchaser if the product fails because of defect due to workmanship and/or materials within the limited warranty period from the date imprinted on the product. Each Limited Warranty as applicable is not transferable and applies to the original installation of the Truck-Lite product. To be eligible for Limited Warranty protection the Truck-Lite products must remain intact, free from physical abuse, and not subject to improper installation. The Limited Warranty of the lamp products applies to 12-volt lamps only. This offer does not constitute in any way a product guarantee and Truck-Lite does not hereby assume any obligation of any kind whatsoever beyond sending a free replacement product. Unless expressly agreed to in writing by Truck-Lite, Truck-Lite does not warrant its products as to their fitness for any special use or function.

Truck-Lite believes our products should provide good service under proper operating conditions. In view of this, many of our products have a Limited Warranty for special periods of time, based on product date. These Limited Warranties are as follows:

- Super 40 series, 4" round sealed lamps (12 volt only) have a thirty-six (36) month limited warranty.
- Model 40 series, 4" round sealed lamps (12 volt only) have a twenty-four (24) month limited warranty.
- Super 10 series, 2-1/2" round sealed lamps (12 volt only) have a twenty-four (24) month limited warranty.
- Super 21 series, rectangular sealed lamps (12 volt only) have a twenty-four (24) month limited warranty.
- Super 45 series, rectangular stop/turn/tail sealed lamps (12 volt only) have a twenty-four (24) month limited warranty.
- Super 60 series, oval stop/turn/tail sealed lamps (12 volt only) have a twenty-four (24) month limited warranty.
- Signal-Stat LED series, see Signal-Stat LED Series Lamp Warranty.
- LED series lamps, see LED Limited Lifetime Lamp Warranty.
- Harness limited warranty, see Harness Warranty.
- LED series lamps and 88 series harness, see LED Limited Lifetime Lamp and Harness System Warranty.

## Signal-Stat LED Series Lamp Warranty



Truck-Lite extends a Limited 2-Year Warranty to the original purchaser that the Signal-Stat Sealed LED lamp is free from defects in workmanship and/or materials only. Truck-Lite will replace any Sealed LED Lamp to the original consumer/purchaser, if the lamp fails due to defects in workmanship and/or materials only.

The LED Limited 2-Year Warranty does not apply to severe applications such as buses, construction equipment and off-road vehicles. These applications are example only and are not all inclusive of each excluded application. Many chemicals and/or cleaners are incompatible with Signal-Stat sealed LED products. The LED 2-Year Warranty does not apply to damage associated with incompatible chemicals or cleaners. Not subject to improper installation or modification and must be used only with Truck-Lite approved wiring accessories. Any violation of these conditions will void this LED 2-Year Lamp Warranty. This LED 2-Year Lamp Warranty is not transferable and applies to the original installation of the Signal-Stat Sealed LED lamp for as long as the original consumer/purchaser owns the vehicle.

## LED Limited Lifetime Lamp Warranty



Truck-Lite extends a Limited Lifetime Warranty to the original purchaser that the Truck-Lite Sealed LED lamp is free from defects in workmanship and/or materials only. Truck-Lite will replace any Sealed LED Lamp to the original consumer/purchaser, if the lamp fails due to defects in workmanship and/or materials only. The LED LIMITED LIFETIME LAMP WARRANTY DOES NOT APPLY TO SEVERE APPLICATIONS such as buses, construction equipment and off-road vehicles. These applications are examples only and are not all inclusive of each excluded applications. MANY CHEMICALS AND/OR CLEANERS ARE INCOMPATIBLE with Truck-Lite Sealed LED products. The LED Limited Lifetime Lamp Warranty does not apply to damage associated with incompatible chemicals or cleaners.

## LED Limited Lifetime Lamp Warranty



However, this LED Limited Lifetime Lamp Warranty will be extended to include exposure to chemicals and/or cleaners associated with use ONLY if Truck-Lite Sealed LED lamps are purchased with the optional "Diamond Shell™" hard coating. Truck-Lite Sealed LED lamps are to REMAIN INTACT, FREE FROM PHYSICAL ABUSE, NOT SUBJECT TO IMPROPER INSTALLATION OR MODIFICATION AND MUST BE USED ONLY WITH TRUCK-LITE APPROVED WIRING ACCESSORIES. ANY VIOLATION OF THESE CONDITIONS WILL VOID THIS LED LIMITED LIFETIME LAMP WARRANTY.

This LED Limited Lifetime Lamp Warranty is not transferable and applies to the ORIGINAL INSTALLATION of the Truck-Lite Sealed LED lamp for AS LONG AS THE ORIGINAL CONSUMER/ PURCHASER OWNS THE VEHICLE (LIFETIME).

Truck-Lite Sealed LED lamps are designed to give the purchaser a wide variety of plug/ connection options. Each plug/connection option offers different performance characteristics. Therefore, Sealed LED lamps have a Limited Lifetime Warranty with the following two exceptions:

- Sealed LED lamps using standard bullet terminal/receptacle type connections integral to the lamp housing will have a three (3) year Limited Warranty.
- Sealed LED lamps, which are hardwired and use standard bullet terminal/receptacle type connections have a limited lifetime warranty on the lamp. Connector failure, however, is covered by a three (3) year Limited Warranty.
- Sealed LED lamps noted with a specific year warranty.

## Limited Harness Warranty



Truck-Lite extends a Limited Harness Warranty to the original consumer/ purchaser that the Truck-Lite Series 50 and Series 88 harness systems are free from defects in workmanship and/or materials only. Truck-Lite will replace any Series 50 or Series 88 harness to the original consumer/ purchaser, if the product fails because of defects due to workmanship and/or materials only within five (5) years from the date of purchase of the product. This Limited Harness Warranty is not transferable and applies to the original installation of the product.

To be eligible for this Limited Harness Warranty protection the Series 50 or Series 88 harness system must have been PROPERLY INSTALLED, PROPERLY MAINTAINED, AND THE INTEGRITY OF THE SYSTEM MUST REMAIN INTACT. Series 50 or Series 88 harness systems MUST BE USED ONLY WITH TRUCK-LITE APPROVED LIGHTING PRODUCTS AND ACCESSORIES. USE OF UNAPPROVED LIGHTING PRODUCTS AND ACCESSORIES WILL VOID THIS LIMITED HARNESS WARRANTY.

## Limited Lifetime LED Lamp & Harness Systems Warranty



Truck-Lite extends a LIMITED LIFETIME LED LAMP AND HARNESS SYSTEMS WARRANTY that Lighting Systems featuring Truck-Lite Series 88 harness and Truck-Lite Sealed LED lamps equipped with Fit 'N Forget connections are free from defects in workmanship and/or materials only. Truck-Lite will replace defective Series 88 harness components and LED lamps with Fit 'N Forget connections to the original consumer/purchaser, if the product fails due to defects in workmanship or materials. This Limited Lifetime LED Lamp and Harness Systems Warranty applies to the original installation of the product only. This Limited Lifetime LED Lamp and Harness Systems Warranty extends for as long as the ORIGINAL CONSUMER/PURCHASER OWNS THE VEHICLE.

MANY CHEMICALS AND/OR CLEANERS ARE INCOMPATIBLE with Truck-Lite Sealed LED products. This Limited Lifetime LED Lamp and Harness Systems Warranty does not apply to damage associated with the use of incompatible chemicals or cleaners (Questions as to compatibility of specific materials should be directed to the manufacturer and/or the Truck-Lite Corporate Laboratory). However, this Limited Lifetime LED Lamp and Harness Systems Warranty will apply and include exposure to chemical/cleaners associated with use ONLY if Truck-Lite Sealed LED lamps are purchased with optional "Diamond Shell™" hard coating.

Truck-Lite Series 88 harness components and Truck-Lite Sealed LED lamps are to be PROPERLY INSTALLED, REMAIN INTACT, FREE FROM PHYSICAL ABUSE, AND NOT SUBJECT TO MODIFICATION. ANY VIOLATION OF THESE CONDITIONS WILL VOID THIS LIMITED LIFETIME LED LAMP AND HARNESS SYSTEMS WARRANTY.

The Truck-Lite Limited Lifetime LED Lamp and Harness Systems Warranty Program does not constitute, in any way, a product guarantee, and Truck-Lite does not assume any obligations of any kind whatsoever beyond sending a free replacement of the product covered by the Limited Lifetime LED Lamp and Harness Systems Warranty.

In no event shall Truck-Lite be liable for incidental or consequential damages, nor shall Truck-Lite's liability for any claims or damage arising out of or connected with this Limited Lifetime LED Lamp and Harness Systems Warranty or the manufacture, sales, delivery or use of the products with which this Limited Lifetime LED Lamp and Harness Systems Warranty is concerned exceed the purchase price of the products.

There are no warranties, expressed or implied (including any warranty of merchantability or fitness), which extend beyond this warranty. The loss of use of the product, loss of time, inconvenience, commercial loss, incidental or consequential damages are not covered. The manufacturer reserves the right to change the design of the product without assuming any obligation to modify any product previously manufactured or to replace warranted product other than with redesigned product.

## Product Warranty

All other products in our catalog may be eligible for a replacement if the failure is deemed to be due to a failure in either material or workmanship within one year of purchase. The replacement of defective products is made at the discretion of Truck-Lite Co., Inc. and is based on the results of an analysis of the returned products by our warranty administrator.

Products submitted for Limited Warranty consideration may be inspected by our laboratory. Replacement will be based upon Truck-Lite uniform limited warranty procedure and/or the result of the laboratory evaluation. Charges for damages and/or labor costs cannot be accepted by Truck-Lite Co., Inc. As stated earlier, we believe our products should provide good service under proper operating conditions, and this attitude will be reflected in our consideration of items returned for examination.

The Truck-Lite Limited Warranty Program does not constitute, in any way, a product guarantee, and Truck-Lite does not hereby assume any obligations of any kind whatsoever beyond sending a free replacement of the product when covered by a Limited Warranty.

There are no warranties, expressed or implied (including any warranty of merchantability or fitness), which extend beyond this Limited Warranty. The loss of use of the product, loss of time, inconvenience, commercial loss, incidental or consequential damages are not covered. The manufacturer reserves the right to change the design of the product without assuming any obligation to modify any product previously manufactured or to replace warranted product other than with redesigned product.

This Limited Warranty gives you special legal rights. You may also have other rights from state to state. Some states do not allow limitations on how long an implied warranty lasts. Some states do not allow the exclusion or limitation of incidental or consequential damages. Therefore, the above limitation(s) or exclusion(s) may not apply to you.

## Product Replacement Instructions

To be eligible for Limited Warranty consideration, contact the Truck-Lite Regional Salesman in your area or call Customer Service at 800/562-5012. Upon issuance of a RETURNED GOODS AUTHORIZATION NUMBER, return the failed product, freight prepaid to Truck-Lite Co., Inc., 2640 First Avenue, Falconer, New York 14733 to the attention of the warranty administrator.

Any product covered under the terms of the respective Limited Warranty will be replaced with another like product and will be sent directly to the original consumer/purchaser only. The consumer/ purchaser may request a written report on any product submitted for warranty evaluation that is not covered under the respective Limited Warranty. Items received will not be returned.

Additional crosses are available online within the advanced catalog search section.

**AMERICAN SUPERLITE**

AMERICAN SUPERLITE PART#	TRUCK-LITE PART #	MATCH LEVEL	AMERICAN SUPERLITE PART#	TRUCK-LITE PART #	MATCH LEVEL	AMERICAN SUPERLITE PART#	TRUCK-LITE PART #	MATCH LEVEL	AMERICAN SUPERLITE PART#	TRUCK-LITE PART #	MATCH LEVEL	AMERICAN SUPERLITE PART#	TRUCK-LITE PART #	MATCH LEVEL
20400	30700	M5	20200A	3050A	M5	40200RC	4051	M5	62100A	1050	M5	82200AC	6051A	M5
25400	10700	M5	20200AC	3051A	M5	40800W	4060C	M5	62100R	2150	M5	82200R	6050	M5
40400	40700	M5	20200RC	3051	M5	40800WU	44308C	M5	62100R	2660A	M5	82200RC	6051	M5
40500	40720	M5	40200A	4050A	M5	42100R	1050A	M5	62100R	3050	M5	82800W	6060C	M5
60400	60700	M5	40200AC	4051A	M5	42100R	2660	M5	80300G	60750	M5	82800WU	6060C	M5
60500	60720	M5	40200R	4050	M5	62100A	2150A	M5	82200A	6050A	M5			

**BETTS**

BETTS PART#	TRUCK-LITE PART #	MATCH LEVEL	BETTS PART#	TRUCK-LITE PART #	MATCH LEVEL	BETTS PART#	TRUCK-LITE PART #	MATCH LEVEL	BETTS PART#	TRUCK-LITE PART #	MATCH LEVEL	BETTS PART#	TRUCK-LITE PART #	MATCH LEVEL
800514	81360	M4	805501	81360	M4	805505	81360	M4	805530	81360	M4			
800516	81360	M4	805503	81360	M4	805507	81360	M4	805531	81360	M4			
800518	81360	M4	805504	81360	M4	805509	81360	M4						

**BLAZER**

BLAZER PART#	TRUCK-LITE PART #	MATCH LEVEL	BLAZER PART#	TRUCK-LITE PART #	MATCH LEVEL	BLAZER PART#	TRUCK-LITE PART #	MATCH LEVEL	BLAZER PART#	TRUCK-LITE PART #	MATCH LEVEL	BLAZER PART#	TRUCK-LITE PART #	MATCH LEVEL
BLAC6423	5050DK	M5	BLAC7421	5050DK	M5									

**CHAM-CAL**

CHAM-CAL PART#	TRUCK-LITE PART #	MATCH LEVEL	CHAM-CAL PART#	TRUCK-LITE PART #	MATCH LEVEL	CHAM-CAL PART#	TRUCK-LITE PART #	MATCH LEVEL	CHAM-CAL PART#	TRUCK-LITE PART #	MATCH LEVEL	CHAM-CAL PART#	TRUCK-LITE PART #	MATCH LEVEL
7202	97720	M5	13501	97618	M5	20731	97837	M5	40305	97667	M5	70101	97869	M5
7325	97721	M5	13503	97619	M5	20851	97643	M5	40401	97846	M5	70111	97748	M5
7326	97722	M5	13504	97620	M5	20852	97644	M5	40403	97668	M5	70201	97823	M5
10300	97990	M5	13601	97621	M5	20901	97645	M5	40404	97669	M5	70203	97849	M5
10303	7044	M5	13603	97622	M5	20903	97646	M5	40601	97848	M5	70311	97876	M5
10400	7048	M5	13604	97623	M5	20904	97647	M5	40603	97670	M5	70401	97718	M5
10481	97865	M5	20000	97624	M5	21101	97840	M5	40604	97671	M5	70503	97719	M5
10501	97872	M5	20080	97625	M5	24403	97811	M5	41301	97847	M5	70601	97845	M5
10503	97802	M5	20090	97626	M5	24404	97806	M5	41303	97672	M5	70701	97725	M5
10601	97819	M5	20100	97860	M5	24413	97650	M5	41304	97673	M5	70703	97726	M5
10603	97820	M5	20101	97812	M5	25503	97818	M5	41601	97674	M5	70841	97730	M5
10681	97602	M5	20200	97627	M5	25504	97808	M5	41603	97675	M5	70851	97731	M5
10683	97603	M5	20203	97628	M5	26200	97652	M5	41604	97676	M5	70911	97868	M5
10701	97815	M5	20204	97629	M5	30101	97653	M5	50101	97678	M5	70931	97732	M5
10703	97816	M5	20210	97630	M5	30103	97654	M5	50201	97850	M5	70961	97733	M5
10801	97803	M5	20230	97631	M5	30104	97807	M5	50203	97679	M5	80501	97734	M5
10803	97804	M5	20250	97632	M5	30201	97655	M5	50301	97852	M5	82701	97740	M5
10891	97606	M5	20301	97822	M5	30301	97656	M5	50304	97680	M5	90012	60737	M5
10893	97831	M5	20311	97809	M5	30303	97657	M5	50401	97681	M5	90013	60738	M5
10901	97863	M5	20321	97826	M5	30401	97800	M5	50801	97682	M5			
11103	97609	M5	20331	97827	M5	30403	97659	M5	60101	97829	M5			
11104	97610	M5	20351	97635	M5	30501	97805	M5	60111	97686	M5			
11105	97835	M5	20601	97861	M5	30504	97660	M5	60151	97687	M5			
11503	97611	M5	20603	97636	M5	30701	97661	M5	60171	97688	M5			
11504	97612	M5	20604	97637	M5	31701	97662	M5	60201	97828	M5			
12701	97817	M5	20611	97866	M5	40101	97862	M5	60601	97843	M5			
12801	97814	M5	20700	97839	M5	40201	97664	M5	60611	97693	M5			
12811	97614	M5	20701	97836	M5	40204	97665	M5	60613	97694	M5			
12813	97615	M4	20711	97837	M5	40303	97666	M5	60699	97695	M5			

Additional crosses are available online within the advanced catalog search section.

**DIALITE**

DIALITE PART#	TRUCK-LITE PART #	MATCH LEVEL	DIALITE PART#	TRUCK-LITE PART #	MATCH LEVEL	DIALITE PART#	TRUCK-LITE PART #	MATCH LEVEL	DIALITE PART#	TRUCK-LITE PART #	MATCH LEVEL	DIALITE PART#	TRUCK-LITE PART #	MATCH LEVEL
13071A	15250Y	M4	17101A	10051Y	M4	41151R	44030R	M4	62091R	60062R	M4	70151R	91252R	M4
13071R	15250R	M4	17101R	10051R	M4	41161R	44036R	M4	65091R	60052R	M4	80001AB	45051Y	M4
15071A	35001Y	M4	18071A	21051Y	M4	41181A	44021Y	M4	65151R	60050R	M4	80131RB	45064R	M4
15071R	35001R	M4	18071R	21051R	M4	41191A	44001Y	M4	70071A	91251Y	M4	80133AB	45063Y	M4
16071A	30050Y	M4	18111A	21056Y	M4	41201A	44027Y	M4	70131AB	91256Y	M4	94007A	44705	M4
16071R	30050R	M4	18111R	21056R	M4	46051C	44350C	M5	70131RB	91255R	M4	95161R	60056R	M4
17071A	10050Y	M4	20071A	25250Y	M4	47051C	44350C	M5	70133AB	91257Y	M4	96007A	60719	M4
17071R	10050R	M4	41141R	44032R	M4	2071R	60061R	M4	70133RB	91257R	M4			

**GROTE**

GROTE PART#	TRUCK-LITE PART #	MATCH LEVEL	GROTE PART#	TRUCK-LITE PART #	MATCH LEVEL	GROTE PART#	TRUCK-LITE PART #	MATCH LEVEL	GROTE PART#	TRUCK-LITE PART #	MATCH LEVEL	GROTE PART#	TRUCK-LITE PART #	MATCH LEVEL
460	97017	M5	16092	97811	M5	28481	97665	M5	43120	19724	M5	43823	10715	M5
470	97018	M5	16101	97808	M5	28483	97664	M5	43202	9199	M4	43830	15729	M5
830	97127	M4	16102	97818	M5	28493	97862	M5	43212	45720	M5	43850	19721	M5
6197	44308C	M5	16123	97822	M5	28663	97621	M5	43220	60117Y1	M5	43901	97960	M5
10025	97721	M4	16123	97836	M5	28663	97623	M5	43220	60126R	M5	43952	60722	M4
10083	97730	M5	16141	97637	M5	28663	97819	M5	43220	60126Y	M5	43952	60728	M4
10113	97732	M5	16142	97636	M5	28763	97865	M5	43220	60126Y1	M5	43952	60733	M4
10173	97823	M4	16153	97866	M5	28912	7226	M5	43220	60366R	M5	43962	15730	M5
10173	97828	M4	16191	97631	M5	28913	7225	M5	43220	60366Y	M5	43970	790	M4
10173	97849	M4	16200	97630	M5	29060	97845	M5	43220	60038R	M5	43980	15405	M4
10623	97748	M4	16202	97629	M5	40192	43	M5	43220	60268R	M5	43990	19720	M5
10623	97869	M5	16223	97827	M5	40193	43A	M5	43230	30720	M5	43990	19740	M5
11133	97718	M5	16223	97837	M5	40232	41	M5	43240	92522Y	M4	44010	270	M4
11293	97733	M5	16244	97627	M5	40233	41A	M5	43240	92644Y	M5	44010	275	M4
12004	7039	M5	16244	97839	M5	40641	98100	M5	43240	92646Y	M5	44030	276	M4
12010	97863	M5	16273	97861	M5	40650	98101	M5	43272	42722	M5	44040	97300	M5
12014	7044	M5	16284	97624	M5	40970	98132	M5	43343	44705	M5	44060	97302	M5
12020	97609	M4	16294	97625	M5	40980	98131	M5	43343	44705-1	M5	44421	92925	M5
12020	97610	M4	16304	97626	M5	40980	98134	M5	43362	60720	M5	44460	192-4	M4
12020	97835	M4	22002	97666	M5	41080	98107	M5	43362	60720-1	M5	44530	172	M5
12071	97807	M5	22012	97694	M4	41093	98110	M5	43370	15006R	M5	44540	173	M5
12072	97654	M5	22013	97693	M5	41111	98155	M5	43370	15006Y	M5	44601	8820	M4
12073	97653	M5	22013	97695	M5	41121	98153	M5	43370	15412	M5	44690	182	M5
12153	97688	M5	22013	97843	M5	41122	98154R	M5	43370	15414	M5	44700	183	M5
12164	7048	M5	22193	97829	M5	41133	98165	M5	43380	15008R	M5	44710	282	M5
12173	97817	M5	22232	97726	M5	41133	98168	M5	43380	15008Y	M5	44720	283	M5
12182	97816	M5	22233	97725	M5	41142	98175R	M5	43380	15414	M5	44730	286	M4
12183	97815	M5	28031	97612	M5	41143	32A	M5	43411	50	M5	44750	264	M4
12301	97673	M5	28031	97620	M5	41143	98175Y	M5	43424	97960	M5	44760	266	M5
12303	97847	M5	28032	97802	M5	41152	98176R	M5	43430	10414	M4	44810	262	M5
12331	97676	M5	28033	97618	M5	41153	98176Y	M5	43463	30708	M5	44820	263	M5
12333	97674	M5	28033	97872	M5	41160	98127	M5	43512	10729	M5	44860	263-4	M5
12333	97848	M5	28041	97623	M5	41170	98146	M5	43522	10730	M5	44891	285	M4
12813	97614	M5	28042	97622	M5	41210	98126	M5	43532	30728	M5	44900	97223	M5
13303	97718	M5	28042	97820	M5	41223	98167	M5	43572	40720	M4	45042	10028R1	M5
16023	97812	M5	28043	97819	M4	41223	98170	M5	43642	40715	M5	45043	10028Y1	M5
16032	97804	M5	28162	97611	M5	42103	60719	M5	43655	40722	M5	45062	30503R	M5
16033	97803	M5	28162	97619	M5	42131	15727	M5	43655	40725	M5	45063	30503Y	M5
16043	97635	M5	28443	97686	M5	42160	15736	M5	43673	9179	M5	45072	10028R	M5
16053	97809	M5	28451	97669	M5	42162	15736	M5	43673	1204A	M5	45072	10525R	M5
16053	97837	M5	28453	97668	M4	43012	9925	M4	43690	30504R	M5	45073	10028Y	M5
16063	97826	M4	28453	97846	M5	43012	9928	M4	43723	60719	M4	45073	10525Y	M5
16091	97806	M5	28461	97840	M5	43022	9288	M5	43782	19729	M4	45082	15506R	M4



Additional crosses are available online within the advanced catalog search section.

GROTE

GROTE PART#	TRUCK-LITE PART #	MATCH LEVEL	GROTE PART#	TRUCK-LITE PART #	MATCH LEVEL	GROTE PART#	TRUCK-LITE PART #	MATCH LEVEL	GROTE PART#	TRUCK-LITE PART #	MATCH LEVEL	GROTE PART#	TRUCK-LITE PART #	MATCH LEVEL
45083	15033Y	M4	46132	30285R	M5	47092	19006R	M5	50652	2751	M5	52691	40229R	M5
45092	19002R1	M5	46133	30285Y	M5	47092	19250R	M5	50652	3763	M5	52692	40029R	M5
45093	19002Y1	M5	46142	10288R	M5	47093	19006Y	M5	50662	2751	M5	52693	40058Y	M5
45152	21205R	M4	46143	10288Y	M5	47093	19250Y	M5	50662	3762	M5	52770	60206R	M5
45153	21205Y	M4	46282	26311R	M5	47102	3075	M5	50792	40757	M5	52772	4050	M4
45162	15201R	M5	46283	26311Y	M5	47102	30201R	M5	50802	40756	M5	52772	40202R	M5
45163	15201Y	M5	46302	1265	M5	47103	3075A	M5	50812	40742	M4	52773	40202Y	M5
45172	1101	M4	46303	1265A	M5	47103	30201Y	M5	50812	40743	M4	52783	4050A	M5
45172	1105	M4	46322	1155	M5	47112	30250R	M4	50812	40746	M4	52822	4026	M5
45172	26315R	M4	46322	1150	M5	47113	30250Y	M4	50812	40747	M4	52832	4025	M5
45172	1117	M4	46322	26354R	M5	47122	1050	M5	50820	40850	M4	52892	60202R	M5
45172	1117A	M4	46323	1155A	M5	47123	1050A	M5	50862	544	M4	52893	60202Y	M5
45173	1101A	M4	46323	1150A	M5	47162	21275R	M4	50862	541	M5	52902	4024Y106	M4
45173	1105A	M4	46323	26354Y	M5	47163	21275Y	M4	50872	80461R	M4	52912	4023Y106	M4
45173	26315Y	M4	46332	26353R	M5	47182	15050R	M4	50872	542	M5	52912	4023	M5
45182	10204R	M5	46333	26353Y	M5	47203	10051Y	M4	50882	80462R	M5	52912	4024	M5
45183	10204Y	M5	46333	26771Y	M5	47212	30276R	M4	50892	80463R	M5	52922	40282R	M5
45202	30206R	M5	46392	1570	M4	47222	10276R	M5	50902	4014	M5	52922	4050	M5
45203	30206Y	M5	46393	1570A	M4	47223	10276Y	M5	50902	4017	M5	52923	40282Y	M5
45232	14200R	M5	46412	15200R	M5	47232	10075R	M5	50912	4013	M5	52923	4050A	M5
45233	14200Y	M5	46412	1560	M5	47233	10075Y	M5	50912	4018	M5	52952	40242R	M5
45252	1555	M5	46413	15200Y	M5	47242	35200R	M5	50920	5061	M5	52952	4050	M5
45253	1555A	M5	46413	1560A	M5	47243	35200Y	M5	50927	5061	M5	52953	40242Y	M5
45262	1259	M5	46543	26765Y1	M5	47262	2673	M5	50942	4015	M5	52953	4050A	M5
45263	1259A	M5	46712	1264D	M5	47263	2673A	M5	50942	4018	M5	53000	2750	M5
45322	1075	M5	46742	19200R	M5	47352	21256R	M5	50952	4016	M5	53000	3812	M5
45323	1075A	M5	46742	1960	M5	47353	21256Y	M5	50952	4017	M5	53012	40028R	M5
45333	1312A	M5	46743	19200Y	M5	47372	10279R	M5	50972	4027	M5	53013	40028Y	M5
45412	1294	M5	46743	1960A	M5	47373	10279Y	M5	50992	5061	M5	53020	2750	M5
45413	1294A	M5	46772	1220	M5	47422	10288R	M4	52062	4091	M4	53020	2803	M5
45462	1233	M4	46773	1220A	M5	47423	10288Y	M4	52062	4094	M4	53032	2751	M4
45462	1205A	M4	46782	1203	M5	47462	35375R	M4	52063	4091A	M4	53032	3712	M4
45463	1233A	M4	46782	2660	M5	47463	35375Y	M4	52063	4094A	M4	53052	2751	M4
45463	1205	M4	46783	1203A	M5	47472	10050R	M4	52072	60253R	M5	53052	2702	M5
45503	25760Y	M5	46783	2660A	M5	47473	10050Y	M4	52072	60264R	M5	53053	2751A	M5
45512	1520	M5	46791	1211W	M5	47492	19275R	M5	52073	60255Y	M5	53053	2702A	M5
45513	1520A	M5	46792	1211	M5	47493	19275Y	M5	52152	40209R	M5	53062	22002R	M5
45522	1520HT	M5	46792	2660	M5	48072	902	M5	52153	4050A	M4	53063	2150A	M5
45523	1520AHT	M5	46793	1211A	M5	48072	910	M5	52153	40209Y	M5	53063	22002Y	M5
45562	30221R	M5	46793	1211AD	M5	48272	905	M5	52182	60283R	M5	53092	60083R	M5
45563	30221Y	M5	46793	2660A	M5	48282	905	M5	52182	6050	M5	53093	60083Y	M5
45811	10202C	M4	46813	1350A	M4	49002	26741R	M4	52183	60283Y	M5	53102	49202R	M5
45812	10202R	M4	46813	25761Y	M4	49062	1523	M4	52183	6050A	M5	53122	60050R	M5
45812	1050	M5	46832	21200R	M4	49082	1215	M4	52193	60215Y	M5	53123	60075Y	M5
45813	10202Y	M5	46833	21200Y	M4	49112	1508R	M5	52202	4550	M5	53132	548D	M5
45813	1050A	M5	46862	29203R	M4	49140	799	M4	52202	45202R	M5	53133	549AD	M5
45821	30200C	M5	46882	1507	M4	49142	10744R	M5	52203	4550A	M5	53163	2150A	M5
45822	3050	M4	46883	1507A	M4	49172	15745R	M5	52203	45202Y	M5	53182	44024Y	M5
45822	30200R	M5	46892	26313R	M4	49173	15745Y	M5	52233	45201Y	M5	53183	44877Y	M4
45822	30200R	M5	46893	26313Y	M4	49252	35200R	M4	52253	60015Y	M5	53212	44882R	M5
45823	3050A	M4	46913	25765Y	M5	49253	35200Y	M4	52323	60315Y	M4	53272	44322R	M5
45823	30200Y	M5	47032	21051R	M4	50132	90327R	M4	52383	60317Y	M4	53282	44038R	M5
45823	30200Y	M5	47033	21051Y	M4	50222	80302R	M5	52512	60215R	M5	53292	44036R	M4
45832	1052	M5	47051	1571W	M5	50222	80302Y	M5	52522	80335R	M5	53312	44202R	M4
45832	10205R	M5	47052	1571D	M5	50232	80334R	M5	52572	60002R	M5	53313	44203Y	M4
45833	1052A	M5	47053	1571AD	M5	50502	80339R	M5	52573	60002Y	M5	53313	44871Y	M4
45833	10205Y	M5	47063	25750Y	M5	50532	80324R	M5	52602	5060	M5	53323	44877Y	M4
45932	1264	M5	47072	21251R	M5	50542	80322R	M5	52602	4028	M5	53413	44201Y	M4
45933	1264A	M5	47072	21880R	M5	50630	2750	M4	52612	80336R	M5	53413	44881Y	M4
45993	26760Y	M4	47073	21251Y	M5	50630	70311	M4	52672	40215R	M5	53422	91244R	M5
46003	25062Y	M4	47073	21880Y	M5	50630	3863	M4	52672	40248R	M5	53422	91272R	M5
46072	21201R	M5	47082	15250R	M5	50642	2751	M5	52682	40048R	M5	53462	44030R	M4
46073	21201Y	M5	47083	15250Y	M5	50642	70310R	M5	52691	40222R	M5	53493	60315Y	M5

Additional crosses are available online within the advanced catalog search section.

## GROTE

GROTE PART#	TRUCK-LITE PART #	MATCH LEVEL	GROTE PART#	TRUCK-LITE PART #	MATCH LEVEL	GROTE PART#	TRUCK-LITE PART #	MATCH LEVEL	GROTE PART#	TRUCK-LITE PART #	MATCH LEVEL	GROTE PART#	TRUCK-LITE PART #	MATCH LEVEL
53503	44887Y	M4	56000	3801	M4	62011	80340	M4	64440	97982	M4	67050	10403	M5
53513	44888Y	M4	56000	3802	M5	62021	92WD	M4	64441	650W	M4	67050	94902	M5
53592	66252R	M4	56000	3806	M5	62051	6060C	M4	64441	80364	M5	67050	94909	M5
53592	66882R	M4	56020	2801	M5	62061	6060C	M4	64461	650W-4	M5	67050	94916	M5
53593	60272Y	M4	56032	3711	M4	62091	4060C	M4	64491	630W4	M5	67050	94919	M5
53593	60872Y	M4	56052	2701	M5	62091	44350C	M4	64561	80438	M5	67050	94924	M5
53622	60256R	M4	56053	2701A	M5	62101	4060C	M4	64741	612W	M4	67090	94993	M5
53622	66256R	M4	56072	6503	M5	62111	60284C	M5	64801	613W	M4	68080	9104	M4
53623	60276Y	M5	56073	6503A	M5	62151	80344	M5	64890	97989	M4	68080	9160	M4
53702	5014K	M5	56083	6501A	M4	62171	40244	M5	64891	80395	M5	68080	9162	M4
53712	5013K	M5	60001	26335-1	M4	62171	40260	M5	64891	80392	M5	68100	9103	M5
53722	5016K	M4	60001	26335	M5	62171	40844	M5	64901	80498	M4	68110	9107	M4
53762	5315Y101	M5	60011	26371	M5	62181	40044	M5	64930	97980	M4	68130	9101	M5
53963	6050A	M4	60021	17001	M4	62181	40084	M5	64930	620H	M5	68170	9102	M5
53963	60891Y	M5	60021	17002	M4	62201	80345	M5	64931	80360-1	M5	68280	96904	M5
54012	2150	M5	60031	21004C	M4	62211	40204	M5	64931	80360	M5	68380	94940	M5
54043	10519Y1	M5	60081	9365W	M4	62231	60204C	M5	64931	80375	M5	68470	80974	M5
54132	6050	M4	60101	26331	M4	62231	60804C	M5	64940	630H	M5	68471	80970	M5
54133	6050A	M4	60151	26330	M5	62251	60004C	M5	64941	630W	M5	68472	80975	M5
54142	6050	M4	60191	17003	M4	62251	60084C	M5	64943	631W	M4	68473	80976	M5
54143	6050A	M4	60191	17200	M4	62321	40012	M5	65370	5050DK	M5	68474	80972	M5
54162	6050	M4	60251	26336	M5	62321	40212	M5	65530	5050DK	M5	68475	80971	M5
54163	6050A	M4	60261	15208	M5	62391	44206C	M4	65782	15041	M5	68680	95000	M5
54172	6050	M5	60271	15200C	M5	62391	44236C	M4	65790	15040	M5	69550	900Y73	M5
54173	6050A	M5	60280	15012	M4	62401	44350C	M4	66100	96959	M5	71152	797	M4
54332	4050	M4	60280	15013	M4	62421	40224	M4	66101	96970	M4	71422	798	M5
54333	4050A	M4	60280	15011	M5	62421	40004	M5	66110	96967	M4	71440	148-18500	M5
54342	4050	M5	60291	19206	M5	62421	40204	M5	66111	96968	M4	71450	148-28500	M5
54343	4050A	M5	60301	19200C	M5	62421	40262	M5	66122	97060	M4	73030	92904	M4
54362	4050	M4	60301	19206	M5	62441	40024	M5	66123	96953	M4	73040	92900	M5
54363	4050A	M4	60311	3613W	M5	62451	40004	M5	66123	97062	M4	73040	92901	M5
55092	81300R	M5	60311	80423C	M5	62561	6060C	M4	66125	96974	M4	73050	92903	M5
55220	70300	M4	60331	21204C	M4	62691	4060C	M5	66160	96960	M5	73080	92905	M5
55223	3850AA	M4	60341	15041	M4	62701	4060C	M4	66161	96973	M4	73090	92902	M4
55232	3711B	M4	60381	15040	M4	63381	80910	M4	66170	96979	M5	73090	92924	M4
55242	3753D	M5	60421	15205	M4	63391	80920	M4	66180	96975	M5	73100	92923	M4
55243	3753AD	M5	60581	84216C	M4	63491	884W	M4	66182	96954	M4	73110	92911	M4
55280	2750	M5	60601	15205	M5	63551	81380	M5	66201	96904	M5	73130	92916	M4
55280	3860	M5	60631	425WD	M5	63561	81360	M4	66202	96919	M5	73160	92918	M4
55290	2750	M5	61031	80490	M5	63571	81360	M4	66360	96930	M5	76121	387	M5
55290	3861	M5	61051	40206C	M5	63581	81360	M4	66800	94850	M5	76163	6822A	M5
55340	2753	M5	61141	44308C	M5	63591	81360	M4	66801	94964	M5	76223	92600Y	M5
55410	4742	M5	61161	80427	M5	63601	81360	M4	66801	94972	M5	76243	92601Y	M5
55420	4869	M4	61161	80482	M5	63611	81360	M4	66810	94932	M5	76451	92611C	M4
55450	4854	M4	61197	44308C	M5	63621	81360	M4	66811	94802	M5	76451	92612C	M4
55450	4754	M4	61261	80251C	M5	63641	81360	M4	66812	94962	M5	76452	92602R	M5
55450	81312Y	M5	61371	80418	M4	63651	81360	M4	66820	94853	M4	76453	92602Y	M5
55460	4855	M5	61371	80444	M4	63661	81360	M4	66830	94706	M4	76453	92602Y	M5
55470	4842	M5	61371	80442	M4	63751	81360	M4	66831	94897	M5	76455	92602B	M5
55572	40241R	M5	61431	40003	M4	63951	81374	M4	66840	94964	M5	76463	6822A	M5
55572	4050	M5	61451	44308C	M5	64021	653H	M5	66844	94882	M5	76483	6823A	M5
55573	40201Y	M5	61501	434WD	M5	64031	657W	M5	66851	94972	M5	76803	92524Y	M4
55573	40241Y	M5	61541	81350	M5	64071	675W	M5	66851	95477	M5	76803	92642Y	M4
55573	4050A	M5	61581	44207C	M4	64221	656W	M4	66930	94862	M5	76823	92685Y	M4
55612	81301R	M5	61611	80251C	M4	64231	652W	M5	66931	94736	M5	76933	92525Y	M4
55612	81301Y	M5	61861	80162C	M4	64231	653W	M5	66931	95410	M5	77013	92560	M5
55772	60201R	M5	61871	80162C	M4	64240	80860	M4	66931	97005	M5	77043	92513Y	M4
55772	6050	M5	61881	80251C	M5	64250	80870	M4	66950	94718	M5	77043	92513Y	M4
55773	60201Y	M5	61921	80162C	M4	64270	80810	M4	66981	94729	M5	77043	92513Y	M4
55773	6050A	M5	61931	80162C	M4	64271	80848	M4	67000	94926	M5	77053	92513Y	M4
55792	60001R	M5	61961	80162C	M5	64280	80820	M4	67002	94707	M4	77071	6611W	M4
55983	91271Y	M5	61971	44207C	M4	64281	80849	M4	67010	94925	M5	77072	6611R	M4
55993	91273Y	M5	61991	80162C	M5	64440	650H	M4	67011	94961	M5	77072	6801R	M4

Additional crosses are available online within the advanced catalog search section.

GROTE

GROTE PART#	TRUCK-LITE PART #	MATCH LEVEL	GROTE PART#	TRUCK-LITE PART #	MATCH LEVEL	GROTE PART#	TRUCK-LITE PART #	MATCH LEVEL	GROTE PART#	TRUCK-LITE PART #	MATCH LEVEL	GROTE PART#	TRUCK-LITE PART #	MATCH LEVEL
77072	6801W	M4	87270	50872	M4	91513	8939A	M4	94100	30050R	M4	40132-3	98003RB	M5
77072	6811R	M4	87860	50860	M4	91513	9074A	M4	94100	30401	M5	40132-4	98003R	M5
77073	92516Y	M4	87890	97100	M5	91581	9016W	M4	94110	9180	M5	40132-5	98003R1	M5
77073	6601A	M4	87890	97100-1	M5	91581	99176C	M4	94180	45700	M5	40133-3	31ADB	M4
77073	6601A	M4	87891	97101	M5	91582	9016	M4	94233	791	M5	40152-4	98006R	M5
77082	6600R	M4	87891	97101-1	M5	91582	9021	M4	97750	318	M4	40153-4	98006Y	M5
77083	6600A	M4	90011	80342	M5	91583	9016A	M4	99140	97031	M5	40232-5	41D	M5
77091	6601W	M4	90012	9029	M4	91583	9021A	M4	99140	97039	M5	40232-5	43D	M5
77091	6610W	M4	90012	99008R	M4	91683	99067Y	M5	99170	97944	M5	40233-5	41AD	M5
77092	6601R	M4	90012	9030	M4	91740	40700	M5	99180	97943	M5	40233-5	43AD	M5
77092	6610R	M4	90013	81300Y	M5	91880	10700	M5	99192	9006	M4	40641-3	98137	M5
77093	6600A	M4	90013	99008Y	M5	91961	99053C	M5	99502	97002	M5	40641-5	98105	M4
77093	6810A	M4	90051	9005W	M4	91962	9007	M5	99593	97945	M5	40650-3	98136	M5
77093	6601A	M4	90052	9005	M4	91963	9006A	M4	99802	99170R	M5	40650-5	98104-1	M5
77095	6601B	M4	90052	99111R	M4	91963	9007A	M4	99832	99169R	M5	41012-4	52TD	M5
77095	6610B	M4	90053	9005A	M4	91964	9007G	M4	99833	99169Y	M5	41013-4	52ATD	M5
77101	307W	M4	90053	99111Y	M4	91965	9007B	M4	99842	99168R	M5	41022-4	42D	M5
77102	307	M4	90092	8904	M4	91992	9057	M4	99843	99168Y	M5	41023-4	42AD	M5
77103	307A	M4	90093	8904A	M4	91992	9075	M4	99850	6606PS	M4	41033-4	54ATD	M5
77105	307B	M4	90121	9093W	M4	91993	9057A	M4	99880	6602PS	M4	41042-4	54TD	M5
77123	92534Y	M4	90122	9093	M5	91993	9075A	M4	99912	8861	M5	41142-1	98175RB	M5
77123	92539Y	M4	90123	9093A	M4	92070	10402	M5	99912	99063R	M5	41143-1	98175YB	M5
77123	6610A	M4	90132	9087	M4	92070	10702	M5	99913	8861A	M5	41152-1	98176RB	M5
77123	6820A	M5	90133	8977A	M4	92070	10714	M5	99913	99063Y	M5	41153-1	98176YB	M5
77133	6601A	M4	90133	9087A	M4	92070	10718	M5	10706201	794	M5	42141-3	15412	M5
77153	92642Y	M4	90152	99041R	M5	92120	30711	M4	12004-5	7039D	M5	43262-5	80720	M5
77193	92553Y	M4	90153	99041Y	M5	92120	30700	M5	12014-5	7044D	M5	43673-5	9179D	M5
77193	92555Y	M4	90162	99034R	M5	92150	30702	M4	12111-5	97660	M5	44810-5	262D	M5
77203	313A	M5	90163	99034Y	M5	92150	30704	M4	12113-5	97805	M5	44840-5	192D	M4
77263	92551Y	M5	90202	8933	M5	92150	30402	M5	12164-5	7048D	M5	44870-5	80594	M5
77273	92554Y	M4	90203	8933A	M4	92420	60120R	M4	12193-5	97800	M5	45022-5	1001D	M5
77273	6859A	M4	90302	9004	M4	92420	60120Y	M4	12201-5	7038	M5	45023-5	1001AD	M5
77353	92550Y	M4	90302	9003	M4	92420	60120Y1	M4	12201-5	7038D	M5	45263-5	1259AD	M5
77362	60122R	M4	90302	99039R	M5	92420	60122Y1	M5	12243-5	97655	M5	45412-5	1294D	M4
77362	60362R	M4	90303	9003A	M4	92420	60403	M5	12263-5	97751	M5	45413-5	1294AD	M4
77362	92551R	M4	90303	99039Y	M5	92420	60700	M5	12272-5	97831	M5	45512-5	1520D	M5
77363	60122Y	M4	90305	99039B	M5	92432	9342	M5	18302-5	7618	M5	45513-5	1520AD	M5
77363	60362Y	M4	90342	99074R	M4	92433	9342A	M4	26012-5	97693	M4	45822-5	30200R1	M5
77365	92551B	M4	90482	9079	M4	92520	15702	M5	28083-5	97749	M5	45823-5	30200Y1	M5
77422	60360R	M4	90502	9063	M4	92581	9021W	M4	28091-5	97680	M5	46412-5	15200R1	M5
77423	60360Y	M4	90761	99007C	M5	92691	9371W	M4	28093-5	97852	M5	46413-5	15200Y1	M5
77583	6600A	M5	90762	99007R	M4	92692	9371	M4	28293-5	97850	M5	46543-5	1320AD	M5
77593	6810A	M5	90763	99007Y	M4	92693	9371A	M4	28313-5	97678	M5	46712-5	1264	M5
77703	92523Y	M4	90783	99128Y	M4	92762	9372	M4	28323-5	97681	M5	46742-5	19200R1	M5
77703	92645Y	M5	90900	80564	M5	92763	9372A	M4	28323-5	97682	M5	46743-5	19200Y1	M5
77703	92646Y	M5	91042	8900	M5	92773	26762Y	M4	28373-5	7575	M5	46792-5	1211D	M5
77723	92645Y	M5	91043	8900A	M5	92773	99066Y	M4	28393-5	7217	M4	46793-5	1211AD	M5
77853	92565Y	M5	91051	80561	M5	92792	8948	M4	28393-5	7218	M4	46882-5	1507D	M5
77863	92565Y	M5	91152	8947	M4	92802	8947	M4	28402-5	7576	M5	46883-5	1507AD	M5
77873	92565Y	M5	91302	9049	M4	92920	10708	M5	28412-5	7577	M5	46892-5	26313Y1	M5
78260	9680A	M4	91302	9071	M4	92951	99172	M5	28423-5	7518	M5	46893-5	26313R1	M5
78322	90326R	M5	91311	99008C	M5	93163	9020A	M5	28433-5	7519	M5	50642-5	3756D	M5
78323	90326Y	M5	91380	15702	M5	93190	50831	M5	28472-5	97679	M4	50852-5	540D	M5
78333	30257Y	M5	91400	10700	M5	93252	9082	M5	28473-5	7555	M5	50972-5	4027D	M5
78343	10212Y	M5	91400	10713	M5	93253	9082A	M4	28473-5	7557	M5	51-9115-01	97094	M5
78363	21210Y	M4	91410	10704	M5	93291	80572	M5	28473-5	97750	M5	52-1005	50868	M5
78393	19205Y	M5	91482	99083R	M5	93301	80573	M5	28790-5	7599	M5	52302-5	535D	M5
78423	30271Y	M4	91502	8938	M4	93311	80572	M5	28792-5	7597	M5	52312-5	534D	M5
87040	97151	M5	91502	9079	M4	93313	80574	M5	28793-5	7596	M5	52513-1	60215YB	M4
87041	97153	M5	91503	8938A	M4	93321	8965W	M5	40052-4	47TD	M5	52892-5	60202R1	M5
87100	97160	M5	91503	9063A	M4	93400	14700	M5	40053-5	47ATD	M5	52893-5	60202Y1	M5
87101	97161	M5	91503	9078A	M4	94000	10404	M5	40072-5	45TD	M5	55220-5	70300-1	M5
87250	50896	M5	91503	9079A	M4	94010	10401	M5	40073-5	45ATD	M5	60101-5	26331-1	M5

Additional crosses are available online within the advanced catalog search section.

GROTE

GROTE PART#	TRUCK-LITE PART #	MATCH LEVEL	GROTE PART#	TRUCK-LITE PART #	MATCH LEVEL	GROTE PART#	TRUCK-LITE PART #	MATCH LEVEL	GROTE PART#	TRUCK-LITE PART #	MATCH LEVEL	GROTE PART#	TRUCK-LITE PART #	MATCH LEVEL
60251-5	26336-1	M5	63503-5	80522	M5	73150-5	329D	M5	G1042	3051	M5	G4603	2660A	M5
60581-3	84216C	M4	63511-5	80513	M5	82-0550	550	M5	G1043	3051A	M5	G5082	5061	M5
60591-3	84216C	M4	63523-5	80519	M5	82-0552	536	M5	G1052	1051	M5	G5092	5060	M5
60601-3	15205	M5	64003-5	80527	M4	82-0552	552	M5	G1053	1051A	M5	G5202	5061	M5
61091-5	9380SWD	M5	64061-5	80525	M4	82-1000	3121	M4	G1082	1075	M5	G5212	5060	M5
61491-5	549SWD	M5	64161-5	80526	M4	82-1001	97159	M5	G1083	1075A	M5	G5300	2750	M5
61581-3	44046C3	M4	64161-5	80553	M4	82-1002	50869	M5	G1092	30275R	M4	G6012	6051	M5
63151-5	610WD	M4	64181-5	80551	M4	82-1016	50888	M5	G1093	30275Y	M4	G6013	6051A	M5
63181-5	629WD	M5	64260-4	80888	M4	82-1020	50886	M5	G1902	1960	M5			
63191-5	628WD	M5	64261-4	80893	M5	82-1021	50885	M5	G1903	1960A	M5			
63201-5	627WD	M5	64261-4	640WK	M5	82-2006	50887	M5	G2102	2150	M5			
63211-5	80396	M5	64290-4	80800	M5	82-2140	97158	M5	G2103	2150A	M5			
63221-5	80397	M5	64291-4	644WK	M5	82-2159	50899	M5	G3002	3050	M4			
63231-5	80394	M5	64931-1	80360-B	M5	82-2160	9414BL	M5	G3002	3051	M5			
63441-4	80893	M5	65340-5	55554-1	M4	82-2163	9415BL	M5	G3003	3050A	M4			
63441-4	645WK	M5	65370-5	533DK	M5	82-2311	3131	M4	G3003	3051A	M5			
63451-4	80893	M5	65402-4	580K	M5	82-5800	52700	M5	G3092	3075	M5			
63455-4	80893	M5	65432-4	44390R	M5	90325Y	90325Y	M5	G3093	3075A	M5			
63481-5	80513	M5	65720-5	44390R1	M5	90971-5	80571	M5	G4002	4050	M5			
63481-5	80520	M5	65730-5	580DK	M5	92701-5	80560	M5	G4003	4050A	M5			
63501-5	80514	M5	72100-5	97361	M4	99167Y	99167Y	M5	G4022	4051	M5			
63501-5	80521	M5	72110-5	97360	M4	G1032	1050	M5	G4023	4051A	M5			
63503-5	80519	M5	73140-5	328D	M5	G1033	1050A	M5	G4602	2660	M5			

HELLA

HELLA PART#	TRUCK-LITE PART #	MATCH LEVEL	HELLA PART#	TRUCK-LITE PART #	MATCH LEVEL	HELLA PART#	TRUCK-LITE PART #	MATCH LEVEL	HELLA PART#	TRUCK-LITE PART #	MATCH LEVEL	HELLA PART#	TRUCK-LITE PART #	MATCH LEVEL
1539	81380	M5												

JETCO

JETCO PART#	TRUCK-LITE PART #	MATCH LEVEL	JETCO PART#	TRUCK-LITE PART #	MATCH LEVEL	JETCO PART#	TRUCK-LITE PART #	MATCH LEVEL	JETCO PART#	TRUCK-LITE PART #	MATCH LEVEL	JETCO PART#	TRUCK-LITE PART #	MATCH LEVEL
126-1011	1050	M5	126-1500A	1560A	M5	127-10211	1960	M5	127-43002	4050	M5			
126-1011A	1050A	M5	126-1900	1960	M5	127-10211A	1960A	M5	127-44050R	4050	M5			
126-1018	3075	M5	126-1900A	1960	M5	127-15000	1560	M5	127-60010	6050	M5			
126-1018A	3075A	M5	126-4040	4050	M5	127-15000A	1560A	M5	127-63002	6050	M5			
126-1019	1075	M5	126-4040A	4050A	M5	127-16002	3050	M5	127-63002A	6050A	M5			
126-1019A	1075A	M5	126-4041W	4060C	M5	127-16002A	3050A	M5	127-66010A	6050A	M5			
126-1211	2660	M5	126-4070	6050	M5	127-17002	1050	M5	127-66050A	6050A	M5			
126-1211A	2660A	M5	126-4070A	6050A	M5	127-17002A	1050A	M5	127-66050R	6050	M5			
126-1500	1560	M5	126-4071W	6060C	M5	127-40010	4050	M5						

MAXXIMA

MAXXIMA PART#	TRUCK-LITE PART #	MATCH LEVEL	MAXXIMA PART#	TRUCK-LITE PART #	MATCH LEVEL	MAXXIMA PART#	TRUCK-LITE PART #	MATCH LEVEL	MAXXIMA PART#	TRUCK-LITE PART #	MATCH LEVEL	MAXXIMA PART#	TRUCK-LITE PART #	MATCH LEVEL
20321R	2675	M5	M11256Y	1052A	M5	M16800Y	1075A	M5	M20330Y	2670A	M5	M20395R	2150	M5
20321Y	2675A	M5	M11260R	10286R	M5	M20320R	1560	M5	M20330Y	2674A	M5	M20395Y	2150A	M5
40800WU	44308C	M5	M11260Y	10286Y	M5	M20320R-01	15507R	M5	M20343R	35740R	M5	M23012R	2660	M5
M09100R	3050	M5	M11300R	1050	M5	M20320Y	1560A	M5	M20350R	1960	M5	M23012Y	2660A	M5
M09100Y	3050A	M5	M11300Y	1050A	M5	M20320Y-01	15507Y	M5	M20350R-01	19032R	M5	M2328R	2751	M5
M09105R	3075	M5	M11325R	1050	M5	M20323R	15050R	M5	M20350Y	1960A	M5	M2328Y	2751A	M5
M09105Y	3075A	M5	M11325Y	1050A	M5	M20327	15408	M5	M20350Y-01	19032Y	M5	M27340R	26270R	M5
M09200R	3050	M5	M16100R	1050	M5	M20328	15409	M5	M20355	19748	M5	M27340Y	26270Y	M5
M09200Y	3050A	M5	M16100Y	1050A	M5	M20330R	2150	M5	M20356	19728	M5	M34100R	3050	M5
M11201R	1075	M5	M16280R	1050	M5	M20330R	2670	M5	M20360Y	18050Y	M5	M34100Y	3050A	M5
M11201Y	1075A	M5	M16280Y	1050A	M5	M20330R	2674	M5	M20390R	2150	M5	M34260R	3050	M5
M11256R	1052	M5	M16800R	1075	M5	M20330Y	2150A	M5	M20390Y	2150A	M5	M34260RCL	3051	M5

Additional crosses are available online within the advanced catalog search section.

MAXXIMA

MAXXIMA PART#	TRUCK-LITE PART #	MATCH LEVEL	MAXXIMA PART#	TRUCK-LITE PART #	MATCH LEVEL	MAXXIMA PART#	TRUCK-LITE PART #	MATCH LEVEL	MAXXIMA PART#	TRUCK-LITE PART #	MATCH LEVEL	MAXXIMA PART#	TRUCK-LITE PART #	MATCH LEVEL
M34260Y	3050A	M5	M42322R	4050	M5	M43253CH	44708	M5	M50903	94840	M5	M63322RCL	6051	M5
M34260YCL	3051A	M5	M42322RCL	4051	M5	M43900	40403	M5	M50904	94897	M5	M63322Y	6050A	M5
M34600R	3075	M5	M42322Y	4050A	M5	M49700	45700	M5	M50950	94924	M5	M63322YCL	6051A	M5
M34600Y	3075A	M5	M42322YCL	4051A	M5	M50100-B	10700	M5	M50951	94964	M5	M63420R	6050	M5
M42100R	4050	M5	M42324	44350C	M5	M50102	10702	M5	M56100R	4050	M5	M63420Y	6050A	M5
M42100R-01	4050	M5	M42325	4060C	M5	M50105	10740	M5	M63100R	6050	M5	M63450R	6050	M5
M42100R-02	4050	M5	M42327	44236C	M5	M50300-B	30700	M5	M63100R-01	6050	M5	M63450Y	6050A	M5
M42100Y	4050A	M5	M42328R/Y	2750	M5	M50305	30713	M5	M63100Y	6050A	M5	M844820	84200C	M5
M42120R	44363R	M5	M42328RYCL	2750	M4	M50310	9179	M5	M63100Y-01	6050A	M5	M844821	84200C	M5
M42200R	4550	M5	M42400	44235C	M5	M50312	35720	M5	M63120Y	60315Y	M5	M90018Y	91271Y	M5
M42200Y	4550A	M5	M42450	4060C	M5	M50400-B	40700	M5	M63150	6060C	M5	M90061R	91272R	M5
M42201RCL	4551	M5	M42500R	4050	M5	M50405	44701	M5	M63200R	60360R	M5	M90081Y	91271Y	M5
M42205R	4550	M5	M42500Y	4050A	M5	M50410	44705	M5	M63200Y	60360Y	M5	MF-30A	97134-1	M5
M42205Y	4550A	M5	M42700R	44211R	M5	M50600-B	60700	M5	M63253	60750	M5	MWL-01	81360	M5
M42220	5060	M5	M42700Y	44211Y	M5	M50605	60703	M5	M63253CH	60750	M5			
M42320R	4050	M5	M43253	44705	M5	M50900	94993	M5	M63322R	6050	M5			

OPTRONICS

OPTRONICS PART#	TRUCK-LITE PART #	MATCH LEVEL	OPTRONICS PART#	TRUCK-LITE PART #	MATCH LEVEL	OPTRONICS PART#	TRUCK-LITE PART #	MATCH LEVEL	OPTRONICS PART#	TRUCK-LITE PART #	MATCH LEVEL	OPTRONICS PART#	TRUCK-LITE PART #	MATCH LEVEL
53CB	44350C	M5	A-91LW	96913	M5	LP-41CB	26371	M4	MC-57RB	10205R	M5	MCL-46AB	2660A	M5
A-11AB	9342A	M5	A-910B	791	M5	LP-42CB	26371	M4	MC-58AB	10202Y	M4	MCL-46RB	2660	M5
A-11RB	9342	M5	A-91RB	15200R	M5	LP-51CB	26371	M4	MC-58RB	10202R	M4	MCL-49AB	2674A	M5
A-13CB	60703	M5	A-91ZB	802	M5	LP-51CPG	26371	M4	MC-62AB	26312Y	M5	MCL-49AB	18050Y	M5
A13GB	60700	M5	AL-80AB	15033Y	M4	LP-52CB	26371	M4	MC-62RB	26312R	M5	MCL-49RB	2674	M5
A-194B	194	M5	AL-80RB	15033R	M4	LP-54CB	26371	M4	MC-65AB	19200Y	M5	MCL-53AB	3050A	M5
A-21AB	9075A	M5	AL-91AB	1560A	M5	LP-55B	80720	M5	MC-65RB	19200R	M5	MCL-53RB	3050	M5
A-21B	9075	M5	AL-91RB	1560	M5	LP-71CB	26336	M5	MC-66AB	1259A	M5	MCL-55AB	3050A	M5
A-21CB	9075W	M5	BK-42CB	26001	M5	LP-81BB	26335	M5	MC-66HAB	1259A	M4	MCL-55RB	3050	M5
A-2RB	8948	M5	BK-45BB	40720	M5	LP-91CB	15208	M5	MC-66RB	1259	M5	MCL-57AB	1050A	M5
A-33GB	45700	M5	BK-57BB	10725	M5	LPL-31CB	434WD	M5	MC-67AB	19002Y	M5	MCL-57RB	1050	M5
A-45BB	44750	M5	BK-70BB	60720	M5	LPL-41CB	26371	M4	MC-67RB	19002R	M5	MCL-58AB	10286Y	M5
A-45CB	94924	M5	BU-40CB	80342	M5	MC-11AB	1507A	M5	MC-67RPG	19002R	M4	MCL-58RB	10286R	M5
A-45GB	40700	M5	BU-41CB	80342	M5	MC-11RB	1507	M5	MC-68AB	1555A	M5	MCL-59AB	1052A	M5
A-45PB	94926	M5	BU-44CB	40004	M5	MC-25AB	30201Y	M5	MC-68RB	1555	M5	MCL-59RB	1052	M5
A-46PB	94924	M5	BU-45CB	40204	M5	MC-25RB	30201R	M5	MC-69AB	1555A	M4	MCL-65AB	1960A	M5
A-46PPG	94924	M5	BU-65CB	60004C	M5	MC-27AB	10203Y	M5	MC-69RB	1555	M4	MCL-65RB	1960	M5
A-47PB	94993	M5	BU-70CB	60204C	M5	MC-27RB	10203R	M5	MC-76AB	1233A	M5	MCL-66AB	35200Y	M5
A-49PB	94992	M5	BU-74CB	60004C	M4	MC-31AB	1264A	M5	MC-76RB	1233	M5	MCL-66RB	35200R	M5
A-54GB	30700	M5	BU-74CBTK	60004C	M4	MC-31AB2	1264A	M5	MC-81AB	2671A	M4	MCL-67AB	1960A	M5
A-54GK	30401	M5	BUL-43CB	4060C	M5	MC-31RB	1264	M5	MC-81RB	2671	M4	MCL-67RB	1960	M5
A-55GB	10700	M5	BUL-52CB	6060C	M5	MC-32AB	1222A	M5	MC-82AB	1101A	M5	MCL-69AB	19275Y	M5
A-55GK	10401	M5	BUL-53CB	4060C	M5	MC-32RB	1222	M5	MC-82RB	1101	M5	MCL-69RB	19275R	M5
A-56GB	10702	M5	BUL-72CB	6060C	M5	MC-35AB	1525A	M4	MC-85AB	1507A	M5	MCL-71AB	2675A	M5
A-57GB	10700	M5	BUL-78CB	66205C	M5	MC-35RB	1525	M4	MC-85RB	1507	M5	MCL-71RB	2675	M5
A-57GK	10401	M5	CB-22AB	1150A	M5	MC-36AB	1570A	M5	MC-91AB	15506Y	M5	MCL-75AB	6050A	M5
A-65B	19728	M5	CB-22RB	1150	M5	MC-36RB	1570	M5	MC-91RB	15506R	M5	MCL-75RB	6050	M5
A-65BPPG	19721	M5	CBL-22AB	1155A	M5	MC-37AB	1570A	M5	MC-92AB	15507Y	M5	MCL-76AB	1233A	M4
A-67CB	19739	M5	IL-21CB	549SWD	M5	MC-38AB	1264A	M5	MC-92RB	15507R	M5	MCL-76RB	1233	M4
A-67CBPG	19739	M5	IL-22CB	549SWD	M5	MC-38RB	1264	M5	MC-95AB	15200Y	M4	MCL-77AB	1960A	M5
A-70GB	60700	M5	IL-61CB	80482	M5	MC-42AB	1211AD	M5	MC-95AB24	15200Y	M4	MCL-77RB	1960	M5
A-78CB	60719	M5	IL-91CB	80351	M5	MC-42RB	1211A	M5	MC-95APG	15200Y	M4	MCL-81AB	2671A	M5
A-80BB	809	M5	LP-10SB	42722	M5	MC-52AB	30221Y	M5	MC-95RB	15200R	M4	MCL-81RB	2671	M5
A-86PB	94902	M5	LP-11CB	26331	M5	MC-52RB	30221R	M5	MCL-21AB	3075A	M5	MCL-86AB	12275Y	M5
A-91AB	1560A	M5	LP-15SB	42722	M4	MC-53AB	4050A	M5	MCL-21RB	3075	M5	MCL-86RB	12275R	M5
A-91BB	802	M5	LP-21CB	26330	M5	MC-53RB	4050	M5	MCL-23AB	1075A	M5	MCL-91AB	1560A	M5
A-91BOB	802	M5	LP-25SB	15730	M5	MC-55AB	10202Y	M5	MCL-23RB	1075	M5	MCL-91RB	1560	M5
A-91CB	791	M5	LP-31CB	434WD	M5	MC-55RB	10202R	M5	MCL-45AB	2660A	M5	MCL-95AB	1560A	M5
A-91GB	15702	M5	LP-31CPG	434WD	M5	MC-57AB	10205Y	M5	MCL-45RB	2660	M5	MCL-95APG	1560A	M4

Additional crosses are available online within the advanced catalog search section.

**OPTRONICS**

OPTRONICS PART#	TRUCK-LITE PART #	MATCH LEVEL	OPTRONICS PART#	TRUCK-LITE PART #	MATCH LEVEL	OPTRONICS PART#	TRUCK-LITE PART #	MATCH LEVEL	OPTRONICS PART#	TRUCK-LITE PART #	MATCH LEVEL	OPTRONICS PART#	TRUCK-LITE PART #	MATCH LEVEL
53CB	44350C	M5	A-49PB	94992	M5	A-91BOB	802	M5	A-91LW	96913	M5	BU-74CB	60004C	M4
A-11AB	9342A	M5	A-54GB	30700	M5	A-91CB	791	M5	A-91OB	791	M5	BU-74CBTK	60004C	M4
A-11RB	9342	M5	A-54GK	30401	M5	A-91GB	15702	M5	A-91RB	15200R	M5	BUL-43CB	4060C	M5
A-13CB	60703	M5	A-55GB	10700	M5				A-91ZB	802	M5	BUL-52CB	6060C	M5
A13GB	60700	M5	A-55GK	10401	M5				AL-80AB	15033Y	M4	BUL-53CB	4060C	M5
A-194B	194	M5	A-56GB	10702	M5				AL-80RB	15033R	M4	BUL-72CB	6060C	M5
A-21AB	9075A	M5	A-57GB	10700	M5				AL-91AB	1560A	M5	BUL-78CB	66205C	M5
A-21B	9075	M5	A-57GK	10401	M5				AL-91RB	1560	M5	CB-22AB	1150A	M5
A-21CB	9075W	M5	A-65B	19728	M5				BK-42CB	26001	M5	CB-22RB	1150	M5
A-2RB	8948	M5	A-65BPPG	19721	M5				BK-45BB	40720	M5	CBL-22AB	1155A	M5
A-33GB	45700	M5	A-67CB	19739	M5				BK-57BB	10725	M5	IL-21CB	549SWD	M5
A-45BB	44750	M5	A-67CBPG	19739	M5				BK-70BB	60720	M5	IL-22CB	549SWD	M5
A-45CB	94924	M5	A-70GB	60700	M5				BU-40CB	80342	M5	IL-61CB	80482	M5
A-45GB	40700	M5	A-78CB	60719	M5				BU-41CB	80342	M5	IL-91CB	80351	M5
A-45PB	94926	M5	A-80BB	809	M5				BU-44CB	40004	M5	LP-10SB	42722	M5
A-46PB	94924	M5	A-86PB	94902	M5				BU-45CB	40204	M5	LP-11CB	26331	M5
A-46PPG	94924	M5	A-91AB	1560A	M5				BU-65CB	60004C	M5	LP-15SB	42722	M4
A-47PB	94993	M5	A-91BB	802	M5				BU-70CB	60204C	M5	LP-21CB	26330	M5

**PETERSON**

PETERSON PART#	TRUCK-LITE PART#	MATCH LEVEL	PETERSON PART#	TRUCK-LITE PART#	MATCH LEVEL	PETERSON PART#	TRUCK-LITE PART#	MATCH LEVEL	PETERSON PART#	TRUCK-LITE PART#	MATCH LEVEL	PETERSON PART#	TRUCK-LITE PART#	MATCH LEVEL
320	2753	M5	143R	1052	M5	717R	91244R	M5	M164R	3050	M5	M417TA-2	4050A	M5
321	2756	M5	313R	2751	M5	717R	91274R	M5	M165A	3050A	M5	M417W-2	81360	M5
324	2752	M5	334-2	2751	M4	850A	4550A	M5	M165R	3050	M5	M420R	4050	M5
325	2752	M5	337-2	2750	M5	M120A	1155A	M5	M166A	3075A	M5	M420R-2	4050	M5
335	2750	M5	417C	4060C	M5	M120R	1155	M5	M166R	3075	M5	M420R-3	4050	M5
337	2750	M5	417R-5	4050	M5	M122XR	2671	M5	M173A	1052A	M5	M420R-5	4050	M5
415	6060C	M5	417YA	4050A	M5	M139A	2660A	M5	M173R	1052	M5	M420SA-1AMP	60360R	M5
540	5050DK	M5	421R	6050	M5	M139R	2660	M5	M188A	2150A	M5	M421A	6050A	M5
907	81374	M4	4258A-1	44211R	M5	M153A	1560A	M5	M188R	2150	M5	M4260A	4050A	M5
1460	80360	M5	4258A-1	44212R	M5	M153C	15205	M5	M2875A-2	60275Y	M5	M4260R-3	4050	M5
4321	4050A	M5	4258A-2	44211Y	M5	M153R	1560	M5	M313-2R	2751	M4	M450A	4550A	M5
4409	80360	M5	4258A-2	44212Y	M5	M161A	1560A	M5	M350A	60315Y	M5	M509	80394	M5
4468	80394	M5	426A	4050A	M5	M161R	1560	M5	M416	6060C	M5	M907	81360	M5
4477	4060C	M5	426R	4050	M5	M162A	1050A	M5	M417C	4060C	M5	V339-2	2751	M4
4486	60275Y	M5	450R	4050	M5	M162R	1050	M5	M417R	4050	M5	V410-2	2751	M4
4487	6050A	M5	505K	80893	M5	M163A	10286Y	M5	M417R-2	4050	M5			
1217A-1	4050A	M5	717A	91243Y	M5	M163R	10286R	M5	M417R-3	4050	M5			
143A	1052A	M5	717A	91273Y	M5	M164A	3050A	M5	M417TA	4050A	M5			

**PHILLIPS**

PHILLIPS PART#	TRUCK-LITE PART#	MATCH LEVEL	PHILLIPS PART#	TRUCK-LITE PART#	MATCH LEVEL	PHILLIPS PART#	TRUCK-LITE PART#	MATCH LEVEL	PHILLIPS PART#	TRUCK-LITE PART#	MATCH LEVEL	PHILLIPS PART#	TRUCK-LITE PART#	MATCH LEVEL
60-2201	80251C	M5	60-2211	80251C	M5	60-2251	80251C	M5						

**PRECO**

PRECO PART#	TRUCK-LITE PART#	MATCH LEVEL	PRECO PART#	TRUCK-LITE PART#	MATCH LEVEL	PRECO PART#	TRUCK-LITE PART#	MATCH LEVEL	PRECO PART#	TRUCK-LITE PART#	MATCH LEVEL	PRECO PART#	TRUCK-LITE PART#	MATCH LEVEL
112	92903	M5	270	92924	M5	1020	92911	M5	4050	92918	M5			
230	92900	M5	360	92903	M5	1040	92905	M5	ELT 248	92910	M5			
240	92901	M5	370	92923	M5	4028	92914	M5	LDA 50	92909	M5			
250	92902	M5	380	92904	M5	4030	92916	M5	SWM 43C	92907	M5			

Additional crosses are available online within the advanced catalog search section.

PRIMA TRONICS

PRIMA TRONICS PART#	TRUCK-LITE PART #	MATCH LEVEL	PRIMA TRONICS PART#	TRUCK-LITE PART #	MATCH LEVEL	PRIMA TRONICS PART#	TRUCK-LITE PART #	MATCH LEVEL	PRIMA TRONICS PART#	TRUCK-LITE PART #	MATCH LEVEL	PRIMA TRONICS PART#	TRUCK-LITE PART #	MATCH LEVEL
PT1000A	10202Y	M5	PT2101A	29203Y	M5	PT3000R-KIT	30503R	M5	PT5175	92902	M5	PTL1013R	1050	M5
PT1000A-KIT	10519Y	M5	PT2101R	29203R	M5	PT3000RS	30222R	M5	PT5412	262	M5	PTL1313A	10276Y	M5
PT1000BK	10729	M5	PT2102A	29202Y	M5	PT4000A	40282Y	M5	PT5413	263	M5	PTL1313R	10276R	M5
PT1000G	10700	M5	PT2102R	29202R	M5	PT4000BK	40720	M5	PT5453	172	M5	PTL1503A	15250Y	M5
PT1000GK	10401	M5	PT2200A	22202Y	M5	PT4000G	40700	M5	PT5454	173	M5	PTL1503A	1560A	M5
PT1000R	10202R	M5	PT2200R	22202R	M5	PT4000R	40282R	M5	PT5469	182	M5	PTL1503R	15250R	M5
PT1000R-KIT	10519R	M5	PT2601A	1259A	M5	PT4000RF	40229R	M5	PT5471	282	M5	PTL1503R	1560	M5
PT1001BK	10728	M5	PT2601A-LN	9093A	M5	PT4000RF	40233R	M5	PT5481	283	M5	PTL1508W	15205	M5
PT1002BK	10725	M5	PT2601R	1259	M5	PT4000R-KIT	40028R	M5	PT6000A	60202Y	M5	PTL1912A	1960A	M5
PT1002G	10702	M5	PT2601R-LN	9093	M5	PT4000W	40204	M5	PT6000BK	60720	M5	PTL1912R	1960	M5
PT1003BK	10410	M5	PT2602A	1211A	M5	PT4002BK	40715	M5	PT6000G	60700	M5	PTL3009A	30285Y	M5
PT1004G	10704	M5	PT2602A-LN	9007A	M5	PT4100R	40248R	M5	PT6000R	60202R	M5	PTL3009A	3050A	M5
PT1100A	10205Y	M5	PT2602R	1211	M5	PT4212RF	80334R	M5	PT6000R-KIT	60002R	M5	PTL3009R	30285R	M5
PT1100R	10205R	M5	PT2602R-LN	9007	M5	PT4212RF-LN	99008R	M5	PT6000W	60204C	M5	PTL3009R	3050	M5
PT1300A	10203Y	M5	PT2605A	1105A	M5	PT4902P	94902	M5	PT6500A	60215Y	M5	PTL3309A	30276Y	M5
PT1300R	10203R	M5	PT2700L	26330	M5	PT4924P	94924	M5	PT9805A	47A	M5	PTL3309R	30276R	M5
PT1500BK	15412	M5	PT2702L	26335	M5	PT4925P	94925	M5	PT9806A	98006Y	M5	PTL3606A	35200Y	M5
PT1500L	15208	M5	PT2703L	15011	M5	PT4926P	94926	M5	PT9806R	98006R	M5	PTL3606R	35200R	M5
PT1500R	15200R	M5	PT2704L	26331	M5	PT4992P	94992	M5	PT9807A	52A	M5	PTL4010R	44351R	M5
PT1500W	15200C	M5	PT3000A	30200Y	M5	PT4993P	94993	M5	PT9807R	52	M5	PTL4010RF	44363R	M5
PT1500Y	15200Y	M5	PT3000AF	30221Y	M5	PT4999P	94888	M5	PT9808A	45ATD	M5	PTL4018A	4050A	M5
PT1900A	19200Y	M5	PT3000AS	30222Y	M5	PT5000A	307A	M5	PT9808R	45TD	M5	PTL4018R	4050	M5
PT1900BK	19721	M5	PT3000BK	30728	M5	PT5000A-LN	9375A	M5	PT9810A	98175Y	M5	PTL5313A	2660A	M5
PT1900R	19200R	M5	PT3000G	30700	M5	PT5021	80360	M5	PT9810R	98175R	M5	PTL5313R	2660	M5
PT1900W	19200C	M5	PT3000GK	30401	M5	PT5023	629WD	M5	PT9832A	54A	M5	PTL6056A	6050A	M5
PT2100A	21201Y	M5	PT3000R	30200R	M5	PT5024	627WD	M5	PT9832R	54	M5	PTL6056R	6050	M5
PT2100R	21201R	M5	PT3000RF	30221R	M5	PT5110	92900	M5	PTL1013A	1050A	M5	PLT1508W	15205	M4

PSE AMBER / CODE 3

PSE AMBER CODE 3 PART#	TRUCK-LITE PART #	MATCH LEVEL	PSE AMBER CODE 3 PART#	TRUCK-LITE PART #	MATCH LEVEL	PSE AMBER CODE 3 PART#	TRUCK-LITE PART #	MATCH LEVEL	PSE AMBER CODE 3 PART#	TRUCK-LITE PART #	MATCH LEVEL	PSE AMBER CODE 3 PART#	TRUCK-LITE PART #	MATCH LEVEL
2100	92678Y	M5	660CCH	92611C	M5	Beacon	92565Y	M5	S51176M	99211C	M5	T03281	99213C	M5
420AH	92642Y	M5	660CH	92612C	M5	LLPMK-1K	92565Y	M4	T01553	99201C	M5	T07891	99216R	M5
420AMH	92644Y	M5	660CRH	92602R	M5	LXEXBIF-AH	92575Y	M5	T01554	99201Y	M5	T07892	99216Y	M5
420ASH	92644Y	M5	7000H	92674Y	M5	LXEXBIF-RH	92575R	M5	T01555	99201R	M5	T07901	99215R	M5
45BZAH	92692Y	M5	8005H	92645Y	M5	LXEXIF-AH	92574Y	M5	T01556	99201B	M5	T07902	99215Y	M5
45BZRH	92692R	M5	8005MH	92646Y	M5	LXEXIF-RH	92574R	M5	T01691	99202R	M5	T07911	99214R	M5
65BZAH	92691Y	M5	85BZAH	92690Y	M5	S50204M	99210Y	M5	T01692	99202B	M5	T07912	99214Y	M5
65BZRH	92691R	M5	85BZRH	92690R	M5	S50260M	99205C	M5	T01693	99202Y	M5	T09352	99200R	M5
660AH	92602Y	M5	B20	6822A	M5	S50424M	99205Y	M5	T02104	99203Y	M5	T09354	99200Y	M5
660CAH	92602Y	M5	B20 MAG	6823A	M5	S50857M	99208C	M5	T02134	99204Y	M5	X391H	92676Y	M5
660CBH	92602B	M5	B20 SUCTION	6823A	M5	S50858M	99209C	M5	T03271	99212C	M5	X394H	92677Y	M5

RE-TRAC

RE-TRAC CODE 3	TRUCK-LITE PART #	MATCH LEVEL	RE-TRAC CODE 3	TRUCK-LITE PART #	MATCH LEVEL	RE-TRAC CODE 3	TRUCK-LITE PART #	MATCH LEVEL	RE-TRAC CODE 3	TRUCK-LITE PART #	MATCH LEVEL	RE-TRAC CODE 3	TRUCK-LITE PART #	MATCH LEVEL
60	97848	M5	396	97865	M5	954	97820	M5	1151	97860	M5	2928	97661	M5
61	97671	M5	812	97800	M5	980	97814	M5	1152	97627	M5	3975	97665	M5
63	97673	M5	821	97659	M5	982	97814	M5	1152	97860	M5	3983	97828	M5
64	97847	M5	822	97800	M5	983	97803	M5	1156	97637	M5	3984	97829	M5
67	97671	M5	872	97817	M5	986	97804	M5	1159	97822	M5	21601	97644	M5
68	97673	M5	873	97815	M5	987	97831	M5	1160	97812	M5	273120	97681	M5
70	97990	M5	876	97816	M5	991	97606	M5	1731	97660	M5	608100	97862	M5
72	97670	M5	880	97803	M5	993	97609	M5	1732	97805	M5	1143H	97650	M5
73	97672	M5	880	97814	M5	1143	97811	M5	2640	97846	M5	1152-1	97860	M5
90	97872	M5	951	97820	M5	1145	97806	M5	2732	97678	M5	1156B	97636	M5
94	97802	M5	952	97819	M5	1146	97818	M5	2762	97852	M5	1157/1162	97861	M5
95	97872	M5	953	97819	M5	1148	97808	M5	2812	97850	M5	1157H	97866	M5

Additional crosses are available online within the advanced catalog search section.

RE-TRAC

RE-TRAC CODE 3	TRUCK-LITE PART #	MATCH LEVEL	RE-TRAC CODE 3	TRUCK-LITE PART #	MATCH LEVEL	RE-TRAC CODE 3	TRUCK-LITE PART #	MATCH LEVEL	RE-TRAC CODE 3	TRUCK-LITE PART #	MATCH LEVEL	RE-TRAC CODE 3	TRUCK-LITE PART #	MATCH LEVEL
1157H-IHN	97866	M5	872-4J5	97817	M5	880-4J5	97814	M5	980H	97614	M5	991J5	97606	M5
1159DV	97635	M5	872J5	97817	M5	880H	97614	M5	980J5	97814	M5	993-4	97609	M5
1159H	97809	M5	873-4	97815	M5	880J5	97803	M5	980SP	97814	M5	993J5	97609	M5
1159HL	97827	M5	873-4J5	97815	M5	880J5	97814	M5	980SPH	97614	M5	J502	97718	M5
1162H	97866	M5	873J5	97815	M5	881-4H	97615	M5	980SPHJ5	97614	M5	J510	97868	M5
1171H	97840	M5	876-4	97816	M5	881H	97615	M5	980SPJ5	97814	M5	J511	97868	M5
398B	97666	M5	876-4J5	97816	M5	96F	97653	M5	981-3H	97615	M5	J512	97718	M5
4MKSS	97823	M5	876J5	97816	M5	97F	97653	M5	981-3HJ5	97615	M5			
661-C	97732	M5	880-4	97803	M5	980-3	97814	M5	981H	97615	M5			
6MKSS	97823	M5	880-4	97814	M5	980-3H	97614	M5	983J5	97803	M5			
762V	97655	M5	880-4H	97614	M5	980-3HJ5	97614	M5	986J5	97804	M5			
872-4	97817	M5	880-4J5	97803	M5	980-3J5	97814	M5	987J5	97831	M5			

STAR HEADLAMP

STAR HEADLAMP PART#	TRUCK-LITE PART #	MATCH LEVEL	STAR HEADLAMP PART#	TRUCK-LITE PART #	MATCH LEVEL	STAR HEADLAMP PART#	TRUCK-LITE PART #	MATCH LEVEL	STAR HEADLAMP PART#	TRUCK-LITE PART #	MATCH LEVEL	STAR HEADLAMP PART#	TRUCK-LITE PART #	MATCH LEVEL
129	92710	M5	135L	99144Y	M5	20TD	92602Y	M5	6020S	92645Y	M5	920-3	99151Y	M5
295	99149Y	M5	181D	92713	M5	211R	6820A	M5	6020SM	92646Y	M5	920-5	92721	M5
297	99149Y	M5	181D4	92714	M5	211RM	6821A	M5	620-21	99191Y	M5	920-99	92720	M5
300	99145Y	M5	181-S	92701	M5	255TC	6601A	M5	820-21	99192Y	M5	ST3901-7	92715	M5
330	99147Y	M5	181Z	92702	M5	255TS	6610A	M5	820-21	99193Y	M5	VL22	92582	M5
333	99150C	M5	200A	92513Y	M5	300S	99146Y	M5	8300H	92668Y	M5	VL22	92583	M5
425	99148Y	M5	200AD	92513Y	M5	325L	99142Y	M5	8300S	92669Y	M5	VL22	92584	M5
3300	92730	M5	200AQ	92513Y	M5	3861-3	92731	M5	8400H	92670Y	M5			
3920	92551Y	M5	200B	92513Y	M5	3901-9	92715	M5	8400S	92671Y	M5			
3920	92551B	M5	200SQ	92516Y	M5	400A	92600Y	M5	8401H	92672Y	M5			
3930	92553Y	M5	201ZMQ	92539Y	M5	400A4	92601Y	M5	8401S	92673Y	M5			
3970	92552Y	M5	201ZQ	92534Y	M5	6020H	92642Y	M5	9200SMQ	92523Y	M5			
134L	99143Y	M5	20RI	6822A	M5	6020HM	92643Y	M5	9200SQ	92522Y	M5			

TECNIQ

TECNIQ PART#	TRUCK-LITE PART #	MATCH LEVEL	TECNIQ PART#	TRUCK-LITE PART #	MATCH LEVEL	TECNIQ PART#	TRUCK-LITE PART #	MATCH LEVEL	TECNIQ PART#	TRUCK-LITE PART #	MATCH LEVEL	TECNIQ PART#	TRUCK-LITE PART #	MATCH LEVEL
S10-0G00-1	10700	M5	S15-RR00-1	1560	M5	S30-AA00-1	3050A	M5	S90-0000-1	15417	M5	T40-RR00-1	4050	M5
S10-AA00-1	1052A	M5	S21-AA00-1	2660A	M4	S30-AC00-1	3051A	M5	S90-0B00-1	15731	M5	T60-0G00-1	60700	M5
S10-RR00-1	1052	M5	S21-AC00-1	2660A	M4	S30-RC00-1	3051	M5	S99-0010-1	94992	M5	T60-RR00-1	6050	M5
S15-0B00-1	802	M5	S21-RC00-1	2660	M4	S30-RR00-1	3050	M5	T40-0BT0-1	44701	M5			
S15-0C00-1	791	M5	S21-RR00-1	2660	M4	S35-AA00-1	3550A	M5	T40-0G00-1	40700	M5			
S15-AA00-1	1560A	M5	S30-0G00-1	30700	M5	S35-RR00-1	3550	M5	T40-RC00-1	4051	M5			



Additional crosses are available online within the advanced catalog search section.

UNIBOND

UNIBOND PART#	TRUCK-LITE PART #	MATCH LEVEL	UNIBOND PART#	TRUCK-LITE PART #	MATCH LEVEL	UNIBOND PART#	TRUCK-LITE PART #	MATCH LEVEL	UNIBOND PART#	TRUCK-LITE PART #	MATCH LEVEL	UNIBOND PART#	TRUCK-LITE PART #	MATCH LEVEL
BD2000	30729	M5	KT3260R	60083R	M5	LED1225-3A	1560A	M5	LED7250A	10276Y	M5	SE1225A	1560A	M5
BD2500	10725	M5	KT3405A	40028Y	M5	LED1225-3R	1560	M5	LED7250R	10276R	M5	SE1225R	1560	M5
BM1020B	15720	M5	KT3405R	40028R	M5	LED1225-6A	1560A	M5	MB2000	30728	M5	SE2000R	3050	M5
BM1020C	791	M5	KT4060A	45002Y	M5	LED1225-6R	1560	M5	MB2238	60720	M5	SE2238A	6050A	M5
BM1020CB	802	M5	KT4060R	45002R	M5	LED2000-4A	3050A	M4	MB2500	10729	M5	SE2238R	60283R	M5
BM1020CG	790	M5	KTL1224A	15033Y	M5	LED2000-4R	3050	M4	MB4000	40720	M5	SE2238R	6050	M5
BM1020R	15728	M5	KTL1225R	15033R	M5	LED2000-9A	3050A	M4	MB4060	45720	M5	SE2238W	6060C	M5
BM1020RB	15733	M4	KTL4040R	44357R	M5	LED2000-9R	3050	M4	ML2030A-CB	2675A	M5	SE2238W	60284C	M5
BM1020RG	15733	M5	KTL4040RSS	44351R	M5	LED2040A	2660A	M5	ML2030R-CB	2675	M5	SE2500A	1050A	M5
BM1021CB	15408	M5	KTL4041A	44024Y	M5	LED2040R	2660	M5	ML2040A	2660A	M5	SE2500R	1050	M5
BM1021CG	15406	M5	KTL4041R	44363R	M4	LED2237A	6050A	M4	ML2040R	2660	M5	SE4000A	40282Y	M5
BM1040B	19721	M5	KTL4042A	44023Y	M5	LED2238-13R	6050	M4	ML7250A	1075A	M5	SE4000A	4050A	M5
BM1040BB	19726	M5	KTL4042R	44363R	M4	LED2238-27A	6050A	M4	ML7250R	1075	M5	SE4000C	40203	M5
BM1040BC	19739	M5	KTL4045A	44023Y	M4	LED2238-63A	6050A	M4	PT6020	94902	M5	SE4000R	40282R	M5
BM2238-1	60722	M5	KTL4045R	44357R	M4	LED2238-63R	6050	M4	PT6020-3	93943	M5	SE4000R	4050	M5
CL3500A	1155A	M5	KTL4050RSS	44357R	M4	LED2500-12A	1050A	M5	PT9180	94926	M5	SE4000W	4060C	M5
CL3500R	1155	M5	KTL4060ASS	44023Y	M4	LED2500-12R	1050	M5	PT9181	94840	M5	SE4000W	40204	M5
CL3501A	1155A	M5	KTR2238A	60015Y	M5	LED2500-4A	1050A	M5	PT9530	94993	M5	SE4060A	4550A	M5
CL3501R	1155	M5	LB1020R	1508R	M5	LED2500-4R	1050	M5	RF1421A	98003Y	M5	SE4060A	45202Y	M5
FM4202RA	2750	M5	LB1030A	35740Y	M4	LED4000-19C	4060C	M4	RF1421R	98003R	M5	SE4060R	4550	M5
FM5203RA	2753	M5	LB1030R	35740R	M4	LED4000-56A	4050A	M4	RF2001A	45A	M5	SE4060R	45202R	M5
FM5403RA	2753	M5	LB1225R	15741R	M5	LED4000-56R	4050	M5	RF2001R	45	M5	SR2238A	60215Y	M5
GR1225	15702	M5	LB2000R	30740R	M5	LED4000-56R	44351R	M5	RF2012A	45A	M5	SR2238R	60215R	M5
GR2000	30700	M5	LB2000RSS	30742R	M5	LED4000-61A	4050A	M4	RF2012R	45	M5	SR2500A	1052A	M5
GR2001	30702	M5	LB2040R	1215	M4	LED4000-61R	4050	M5	RF2421A	54A	M5	SR2500R	1052	M5
GR2238	60700	M5	LB2500R	10744R	M5	LED4000A	4050A	M5	RF2421R	54	M5	SR4000R	40285R	M5
GR2239	60704	M5	LB2500RSS	10745R	M5	LED4040-56R	44363R	M5	RF3001A	47A	M5	SW2238A	60283Y	M5
GR2500	10713	M5	LB7250R	26741R	M4	LED4040-61R	44363R	M5	RF3001R	47	M5	SW2238C	60284C	M5
GR2501	10714	M5	LBL1225R	1560	M5	LED4040A	44223Y	M4	RF3012A	98006Y	M5	TL6400	5060	M5
GR2502	10708	M5	LBL2000R	3050	M5	LED4060-60A	45251Y	M5	RF3012R	98006R	M5			
GR2504	10700	M5	LED0750A	35001Y	M5	LED4060-60R	45258R	M5	RF3022A	41A	M5			
GR4000	40700	M5	LED0750R	35001R	M5	LED4060A	45251Y	M5	RF3022R	41	M5			
GR4060	45700	M5	LED1040-12A	1960A	M5	LED7000A	91243Y	M5	RF3023A	41A	M5			
KT3207	30404	M5	LED1040-12R	1960	M5	LED7000R	91244R	M5	RF3023R	41	M5			
KT3257	10414	M5	LED1040-6A	1960A	M5	LED7007A	91241Y	M5	SE1040A	1960A	M5			
KT3260A	60083Y	M5	LED1040-6R	1960	M5	LED7007R	91244R	M5	SE1040R	1960	M5			

VELVEC

VELVEC PART#	TRUCK-LITE PART #	MATCH LEVEL	VELVEC PART#	TRUCK-LITE PART #	MATCH LEVEL	VELVEC PART#	TRUCK-LITE PART #	MATCH LEVEL	VELVEC PART#	TRUCK-LITE PART #	MATCH LEVEL	VELVEC PART#	TRUCK-LITE PART #	MATCH LEVEL
700064	97843	M5	708005	97861	M5	708470	97872	M5	708521	97802	M5	723047	97828	M5
704068	97733	M5	708008	97866	M5	708471	97802	M5	708525	97837	M5	723065	97990	M5
704093	97674	M5	708020	97637	M5	708474	97611	M5	708526	97836	M5	723080	97718	M5
704095	97848	M5	708022	97861	M5	708476	97621	M5	709002	97805	M5	723083	97868	M5
704159	97675	M5	708046	97866	M5	708477	97622	M5	709004	97660	M5	748216	97869	M5
705038	97627	M5	708211	97840	M5	708478	97819	M5	709218	97863	M5	704040-5	97848	M5
705050	97860	M5	708212	97840	M5	708479	97820	M5	709276	97660	M5	704152-5	97672	M5
705102	97812	M5	708331	97827	M5	708501	97803	M5	712479	97681	M5	704153-5	97670	M5
705104	97811	M5	708441	97803	M5	708502	97814	M5	712643	97862	M5			
705105	97806	M5	708442	97804	M5	708503	97804	M5	713120	97665	M5			
705107	97632	M5	708444	97814	M5	708508	97815	M5	713121	97664	M5			
705332	97837	M5	708448	97606	M5	708509	97817	M5	713444	97686	M5			
705333	97822	M5	708449	97831	M5	708510	97816	M5	713445	97829	M5			
705334	97635	M5	708457	97614	M5	708515	97819	M5	714620	97688	M5			
708001	97636	M5	708467	97618	M5	708516	97820	M5	714721	97687	M5			
708003	97637	M5	708468	97619	M5	708520	97872	M5	721090	97846	M5			

Additional crosses are available online within the advanced catalog search section.

VSM

VSM PART#	TRUCK-LITE PART #	MATCH LEVEL	VSM PART#	TRUCK-LITE PART #	MATCH LEVEL	VSM PART#	TRUCK-LITE PART #	MATCH LEVEL	VSM PART#	TRUCK-LITE PART #	MATCH LEVEL	VSM PART#	TRUCK-LITE PART #	MATCH LEVEL
VSM1010	1050	M5	VSM1045A	3075A	M5	VSM1900	1960	M5	VSM2803	2750	M5	VSM4801	2753	M5
VSM1011	1051	M5	VSM1050	1075	M5	VSM1905AX	1960A	M5	VSM3074	2751	M5	VSM6064	6050	M5
VSM1015AX	1050A	M5	VSM1055	1075	M5	VSM1905X	1960	M5	VSM3704A	2751A	M5	VSM6464	6050	M5
VSM1015X	1050	M5	VSM1055A	1075A	M5	VSM2101	2150	M5	VSM3812	2750	M5	VSM6464	6050	M5
VSM1030	3050	M5	VSM1203	2660	M5	VSM2105	2150	M5	VSM4064	4050	M5	VSM6464rc	6051	M5
VSM1035AX	3050A	M5	VSM1255AX	2660A	M5	VSM2105A	2150A	M5	VSM4464	4050	M5			
VSM1035X	3050	M5	VSM1255X	2660	M5	VSM2311	2150	M5	VSM44644	4050	M5			
VSM1040	3075	M5	VSM1500	1560	M5	VSM2702	2751	M5	VSM4464rc	4051	M5			
VSM1045	3075	M5	VSM1505X	1560	M5	VSM2702A	2751A	M5	VSM4564	4550	M5			

WAGNER

WAGNER PART#	TRUCK-LITE PART #	MATCH LEVEL	WAGNER PART#	TRUCK-LITE PART #	MATCH LEVEL	WAGNER PART#	TRUCK-LITE PART #	MATCH LEVEL	WAGNER PART#	TRUCK-LITE PART #	MATCH LEVEL	WAGNER PART#	TRUCK-LITE PART #	MATCH LEVEL
795	80564	M5	7216	270	M5	7410	256	M5	1255/H1	80563	M5	852/5X	242	M5
7210	250	M5	7220	282	M5	7410	286	M5	1255/H3	80571	M5			
7210	262	M5	7310	263	M5	7410	97201	M5	2470/H2	80561	M5			
7210	97231	M5	7316	275	M5	7510	245	M5	795X	80564	M5			
7212	97210	M5	7320	283	M5	1210/H3	80560	M5	850/5X	243	M5			

WHELEN

WHELEN PART#	TRUCK-LITE PART #	MATCH LEVEL	WHELEN PART#	TRUCK-LITE PART #	MATCH LEVEL	WHELEN PART#	TRUCK-LITE PART #	MATCH LEVEL	WHELEN PART#	TRUCK-LITE PART #	MATCH LEVEL	WHELEN PART#	TRUCK-LITE PART #	MATCH LEVEL
21	92565Y	M5	2004BLAM	6600MA	M5	5020-0000-10	99171R	M5	68-3182182-20099227B		M5	EXT5	92847	M5
02-0363445-00	92833	M5	2012BHAM	6601MA	M5	5020-0000-20	99171Y	M5	68-3182182-30099227C		M5	H50ASN12	60-50124	M5
1000-1100-20	90325Y	M5	2012BLAM	6600MA	M5	5025-0000-00	26724	M5	68-3182182-50099227R		M5	MIRRRRMT	92833	M5
1002-0000-20	99167Y	M5	2015BHAM	6601MA	M5	5050-1400-10	26354R	M5	68-3182183-10099226Y		M5	MKC29S	92687Y	M5
1003-0000-10	99168R	M5	2015BLAM	6810MA	M5	5050-1400-20	26354Y	M5	68-3182183-20099226R		M5	RB6PAM	6823A	M5
1003-0000-20	99168Y	M5	2022BHAM	6811MA	M5	68-1141474-10A99224Y		M5	68-3182183-30099226C		M5	S225CC	92844	M5
1004-0000-10	99169R	M5	2022BLAM	6810MA	M5	68-1983816-10	99228Y	M5	68-3182183-50099226B		M5	S30HACP	92846	M5
1004-0000-20	99169Y	M5	212650-02	92565Y	M4	68-1983817-10	99230Y	M5	7000-0000-01	97223	M5	S660CCCC	92845	M5
1010-1120-10	90327R	M5	212660-02	92565Y	M4	68-1983817-20	99230B	M5	8004-0000-30	99172	M5	SLPMMAA	92585	M5
1010-1120-20	90327Y	M5	5000-1400-10	26353R	M5	68-1983817-30	99230C	M5	8005-1000-30	81350	M5	STPKT54S	92841	M5
1020-1100-10	90326R	M5	5000-1400-20	26353Y	M5	68-1983817-50	99230R	M5	9M148000	92687Y	M5	STPKT55S	92842	M5
1020-1100-20	90326Y	M5	5002-0000-10	99170R	M5	68-2141859-10E99218Y		M5	9M2LAA	92687Y	M5	VB247AAA	92685Y	M5
2004BHAM	6601MA	M5	5002-0000-20	99170Y	M5	68-3182182-10099227Y		M5	9MCPA	99229Y	M5	VB447AAA	92684Y	M5

Truck-Lite Part No.	Page No.	Truck-Lite Part No.	Page No.	Truck-Lite Part No.	Page No.
00790	360	10051Y	123	10213Y	147
00791	360	10075R	122	10250R	122
00792	360	10075Y	122	10250Y	122
00793	360	10076R	122	10251R	123
00794	345	10076Y	122	10251Y	123
00798	345	10079R	123	10256R	122
00799	345	10079Y	123	10256Y	122
00801	362	10085R	122	10271Y	123
00802	361	10085Y	122	10275R	122
00808	348	10086R	122	10275Y	122
00809	361	10086Y	122	10276R	126
00814	363	10089R	123	10276Y	126
00815	356	10089Y	125	10279R	123
00816	356	10090R	123	10279Y	123
00817	348	10090Y	123	10286R	122
04115	303	10091R	125	10286Y	122
04116	302	10091Y	125	10288R	125
07021	318	10092R	125	10288Y	124
07022	371	10092Y	125	10289R	123
07080	92	10133	343	10289Y	124
07081	43	10136	343	10375R	122
07082C	206	102	513	10375Y	122
07092	43	10202B	145	10379R	123
07093	43	10202C	298	10379Y	123
07096C	206	10202G	145	10385R	122
07097	75	10202R	145	10385Y	122
07098	43	10202Y	145	10389R	124
07168	378	10203B	146	10389Y	124
07332	310	10203G	146	10391R	124
07393	140	10203R	146	10391Y	124
07394	140	10203Y	146	10400	343
07395	140	10204C	298	10401	379
07396	140	10204R	145	10402	380
10004R	146	10204Y	145	10403	379
10004Y	146	10205R	145	10404	379
10028R	147	10205Y	145	10410	343
10028Y	147	10208R	147	10412	344
10050R	122	10208Y	147	10413	344
10050Y	122	10209C	298	10414	343
10051R	123	10212Y	147	10520R	146

Truck-Lite Part No. Page No. Truck-Lite Part No. Page No. Truck-Lite Part No. Page No.

10520Y	146	1216A	171	15042	182
10525R	145	12200C	299	15043	182
10525Y	145	12200R	148	15050R	166
10700	379	12200Y	148	15050Y	166
10701	379	12201R	148	15053	182
10702	380	12201Y	148	15054	182
10704	379	12275R	126	15055	182
10706	379	12275Y	126	15056	182
10708	379	125	337	15058	182
10713	379	12723	345	15059	182
10714	380	12724	345	15060	182
10715	345	12725	345	15061	182
10718	380	13001C	149	1506W	305
10719	379	13001G	149	1508R	171
10720	342	13001R	149	15200C	299
10721	342	13011C	149	15200R	150
10722	344	13011R	149	15200Y	150
10724	342	13011Y	149	15201R	150
10725	345	131	515	15201Y	150
10727	342	13200C	149	15203Y	150
10728	342	13200R	149	15205	182
10729	342	13200Y	149	15208	185
10730	342	13210C	149	15209	185
10731	342	13210R	149	15226	182
10732	344	13210Y	149	15227	182
10738	342	14200R	150	15250R	126
10740	379	14200Y	150	15250Y	126
10744R	169	14700	380	15401	348
10745R	169	14701	380	15404	346
1105W	190	15006R	151	15405	346
12001R	148	15006Y	151	15406	346
12001Y	148	15008R	151	15407	346
12001Y	148	15008Y	151	15408	346
12003R	148	15011	185	15409	346
12003Y	148	15012	185	15412	347
12004R	148	15013	185	15414	347
12004Y	148	15033R	127	15415	151
1211W	305	15033Y	127	15416	151
1215	171	15040	182	15417	127
1216	171	15041	182	15418	127

Truck-Lite Part No.	Page No.	Truck-Lite Part No.	Page No.	Truck-Lite Part No.	Page No.
15506R	151	18300R	151	194	337
15507R	151	18300Y	151	195	337
15507Y	151	190	336	19680A	286
15702	381	19002R	152	19720	349
15720	348	19002Y	152	19721	351
15727	347	19006R	130	19721	349
15728	347	19006Y	130	19722	350
15729	346	19009R	152	19724	349
15730	346	19009Y	152	19726	351
15731	346	19016R	152	19726	349
15732	346	19016Y	152	19728	350
15733	347	19020R	130	19729	349
15736	361	19020Y	130	19737	350
15741R	169	19031R	129	19738	350
15745R	169	19031Y	129	19739	349
15745Y	169	19032R	129	19740	349
15905	182	19032Y	129	19748	350
17001	186	19036R	129	19748	350
17002	186	19036Y	129	19750	350
17003	186	19037R	129	20301Y	68
172	328	19037Y	129	20302	300
17200	185	191	336	20304Y	68
173	328	192	336	20308	300
17720	363	19200C	299	20309Y	68
18011C	128	19200R	152	20310Y	68
18011Y	128	19200Y	152	20316Y	68
18050R	128	19205Y	152	21001R	155
18050Y	128	19206	186	21001Y	155
18060R	128	1924	337	21002R	156
18060Y	128	19250R	129	21002Y	156
18070R	128	19250Y	129	21004C	188
18070Y	128	19251R	129	21005R	155
18085R	128	19251Y	129	21005Y	155
18085Y	128	19275R	129	21051R	132
18088R	128	19275Y	129	21051Y	132
18088Y	128	192D	336	21056R	132
18090R	128	19350R	129	21056Y	132
18090Y	128	19350Y	129	21075R	131
182	328	19375R	129	21075Y	131
183	328	19375Y	129	21080R	132

Truck-Lite Part No. Page No. Truck-Lite Part No. Page No. Truck-Lite Part No. Page No.

21080Y	132	22016Y	68	26311Y	158
21090Y	131	22202R	68	26312R	159
21091Y	131	22202Y	68	26312Y	159
21092Y	131	242	329	26313R	158
21093Y	131	243	329	26313Y	158
21094Y	131	245	333	26315R	158
21095Y	131	250	330	26315Y	158
21096Y	131	25062Y	157	26330	189
21200R	154	25250R	133	26331	188
21200Y	154	25250Y	133	26336	188
21201R	155	25256Y	132	2634	329
21201Y	155	256	330	26353R	158
21204C	187	25750Y	133	26353Y	158
21205R	154	25760Y	156	26354Y	160
21205Y	154	25761Y	156	26371	189
21210Y	154	25762Y	157	26380	351
21251R	132	25765Y	157	26390Y	160
21251Y	132	25766R	157	26391C	300
21256R	132	25766Y	157	26392C	300
21256Y	132	25780R	156	26393C	300
21271R	44	25784R	133	26394C	300
21275R	130	25784Y	133	264	329
21275Y	130	2584	330	266	329
21501Y	156	26001	303	26723	351
21502R	156	26002	351	26724	351
21506R	154	262	328	26740R	170
21506Y	154	26225	189	26741R	170
21507R	156	26250R	134	26760Y	159
21507Y	156	26250Y	134	26762Y	158
21720	360	26251R	134	26765R	160
21721	360	26251Y	134	26765Y	160
21722	360	26254R	160	26771R	160
21880R	132	26270R	134	26771Y	160
21880Y	132	26270Y	134	26901R	160
22002R	68	263	329	26901Y	159
22002Y	68	26302B	159	26902R	160
22004R	68	26302G	159	26902Y	160
22004Y	68	26310R	159	270	331
22006R	68	26310Y	159	27004	236
22006Y	68	26311R	158	27009	235

Truck-Lite Part No.	Page No.	Truck-Lite Part No.	Page No.	Truck-Lite Part No.	Page No.
27009-1	235	29202Y	153	30200C	300
2701	96	29203R	153	30200G	161
27010	235	29203Y	153	30200R	161
27012	236	29204C	187	30200Y	161
27012-1	236	30001R	162	30201R	163
2701A	96	30001Y	162	30201Y	163
2702	97	30050R	139	30204R	161
2702A	97	30050Y	139	30204Y	161
270Y1014	331	30051R	135	30206C	300
27270C	232	30051Y	135	30206G	161
27275C	233	30055R	139	30206R	161
27290C	234	30060R	135	30206Y	161
27291C	234	30060Y	135	30221R	163
27450C	231	30061R	137	30221Y	163
27490C	234	30061Y	137	30222R	162
27491C	234	30062Y	137	30222Y	162
275	331	30065Y	135	30223R	162
2750	94	30066R	135	30223Y	162
2751	94	30066Y	135	30230Y	161
2751A	94	30070R	139	30250R	138
2752	94	30070Y	139	30250Y	138
2753	95	30071R	135	30251R	136
2756	95	30071Y	135	30251Y	136
2758	95	30075R	139	30255Y	138
2759	95	30075Y	139	30257Y	161
276	331	30080R	137	30262R	136
27640C	230	30080Y	137	30262Y	136
27645C	230	30085R	139	30264Y	138
2801	98	30085Y	139	30265R	136
2803	100	30086R	139	30265Y	136
282	328	30086Y	139	30269Y	136
283	328	30090R	137	30270R	138
285	331	30090Y	137	30270Y	138
286	328	30091R	135	30271Y	136
29002R	153	30091Y	135	30272R	134
29002Y	153	300A	275	30272Y	134
29003R	154	30133	353	30273R	138
29003Y	154	30136	353	30273Y	138
29004C	187	301A	276	30275R	138
29202R	153	30200B	161	30275Y	138

Truck-Lite Part No. Page No. Truck-Lite Part No. Page No. Truck-Lite Part No. Page No.

30275Y	138	30722	354	33062Y	293
30276R	138	30727	352	33065B	290
30276Y	138	30728	352	33065C	290
30279R	136	30729	352	33065G	290
30279Y	136	30730	353	33065PR	290
30285R	138	30731	352	33065Y	290
30285R	138	30740R	170	33066B	291
30285Y	138	30742R	170	33066C	291
30286R	260	307A	275	33066G	291
30286R	261	3121	442	33066PR	291
30286Y	260	313A	276	33066R	291
30286Y	261	31ADB	489	33066Y	291
30288R	136	31DB	489	33067B	291
30288Y	136	32	489	33067C	291
30289R	136	328D	509	33067G	291
30289Y	136	329D	509	33067PR	291
30379R	136	32A	489	33067R	291
30379Y	136	32ADB	489	33067Y	291
30386R	136	32DB	489	33070R	142
30386Y	136	33010C	183	33071R	142
30400	354	33050Y	142	33072R	142
30401	381	33051R	141	33075R	142
30402	382	33051Y	141	33075Y	142
30404	354	33060B	292	33080R	141
30410	353	33060C	292	33080Y	141
30503R	161	33060G	292	33095G	290
30503Y	161	33060PR	290	33203R	142
30504R	162	33060R	292	33203Y	142
30504Y	162	33060Y	292	33204R	142
3055Y	139	33061B	293	33204Y	142
30700	381	33061C	293	33205R	142
30701	381	33061G	293	33205Y	142
30702	382	33061PR	293	33206R	142
30704	382	33061R	293	33206Y	142
30706	381	33061Y	293	33207R	140
30707	381	33062B	293	33207Y	141
30708	354	33062C	293	33208R	140
30711	381	33062G	293	33208Y	141
30720	353	33062PR	291	33209Y	142
30721	354	33062R	293	33210C	183



Truck-Lite Part No.	Page No.	Truck-Lite Part No.	Page No.	Truck-Lite Part No.	Page No.
33250R	142	35035R	167	36204C	293
33256Y	142	35036R	168	36205C	293
33260B	292	35075R	143	36213R	144
33260C	292	35075Y	143	36214C	293
33260G	292	35080R	143	36215C	293
33260PR	292	35080Y	143	36705	362
33260R	292	35200R	143	36710	357
33260Y	292	35200Y	143	36711	357
33265B	290	35201R	143	3691W	205
33265C	290	35201Y	143	3693W	205
33265G	290	35207Y	143	37	490
33265PR	290	35209Y	143	3701	96
33265R	290	35375R	143	3702	97
33265Y	290	35375Y	143	3710	96
33275R	142	35720	356	3711	96
33275Y	142	35740R	167	3711B	96
33285R	142	35740Y	167	3712	97
33285Y	142	35741R	167	3753	97
33700	382	35741Y	167	3753A	97
33702	383	35880R	143	3754	98
33705	382	35880Y	143	3755	97
33710	355	35890R	143	3755A	97
33711	356	35890Y	143	3756	98
33712	355	36041C	184	3762	97
33715	355	36042C	184	3801	98
33720	382	36100R	144	3802	98
33725	382	36100Y	144	3805Y115	100
33740R	166	36105R	144	3806	98
33751R	166	36105Y	144	3810	100
33800	355	36110R	144	3812	100
33805	356	36110Y	144	3850	101
33810	355	36115R	144	3850AA	101
35001R	143	36115Y	144	3853AA	99
35001Y	143	36130R	144	3854	100
35004R	143	36130Y	144	3860	98
35004Y	143	3613W	205	3861	99
35007Y	143	36140C	184	3862	100
35009Y	143	36145C	184	3863	100
35033R	167	36203R	144	40002R	30
35034R	168	36203Y	144	40002Y	86

Truck-Lite Part No. Page No. Truck-Lite Part No. Page No. Truck-Lite Part No. Page No.

40003	301	40229R	34	4060C	195
40004	198	4023	48	40626	108
40006R	31	40232R	31	40627	108
40009R	30	40233R	32	40637	108
40009Y	86	40233Y	86	40638	108
40011	301	4023Y106	49	4063C	196
40012	198	4024	48	40658	115
40015R	32	40241R	69	40680	359
40023	302	40241Y	69	40681	359
40024	199	40242R	35	40700	383
40028R	33	40244	200	40701	383
40028Y	87	40247R	46	40702	383
40029R	34	40248R	35	40703	383
40041Y	69	4024Y106	49	40715	358
40042R	35	40258R	36	40719	358
40044	200	40259R	36	40720	357
40048R	36	40260	200	40721	358
40058R	36	40261	200	40722	359
40071	199	40262	199	40725	358
4015	51	4027	52	40726	359
4016	51	40270C	312	40742	112
4017	52	40271C	312	40743	112
4018	52	40275C	312	40746	113
40202R	30	4027D	52	40747	113
40202Y	86	4028	49	40748	116
40203	301	40282R	33	40749	116
40204	198	40282Y	87	40754	116
40206C	198	40285R	34	40755	116
40206R	31	40302R	30	40756	114
40206Y	86	40302Y	86	40757	114
40207	301	40306	198	40759	115
40209R	30	40403	383	40762	113
40209Y	86	4050	27	40763	113
40211	301	4050A	83	40790	114
40212	198	4051	27	40791	114
40215R	31	4051A	83	40802	69
40222R	32	4053	27	40803	69
40223	302	4053A	83	40804	69
40224	199	4058	27	40805	69
40227	301	4058A	83	40808	110

Truck-Lite Part No.	Page No.	Truck-Lite Part No.	Page No.	Truck-Lite Part No.	Page No.
40809	110	44030R	14	44202R	19
40810	357	44032R	16	44203Y	78
40819	383	44034R	16	44205C	194
40850	115	44036R	16	44206C	193
40894	109	44038R	16	44207C	294
4091	72	44040C	194	44211R	261
4091A	72	44041C	193	44211Y	261
4093	72	44042C	294	44212R	262
4093A	72	44044C	195	44212Y	262
4094	73	44045C	194	44213R	263
4094A	73	44057C	294	44213Y	263
4094SW	304	44071Y	78	44214R	263
4095	73	44082R	19	44214Y	263
4095A	73	44083R	20	44216R	263
4097A	92	44091Y	76	44216Y	263
41	487	44092R	14	44217Y	260
41005R	37	44092Y	77	44218Y	260
41006R	37	44093Y	77	44221Y	59
41007R	37	44094Y	76	44222R	20
41008R	37	44095Y	77	44223Y	79
41202R	37	44101R	262	44224Y	79
41203R	37	44101Y	262	44226R	20
41A	487	44102R	262	44227Y	59
425WD	190	44102Y	262	44231Y	59
426W	190	44103R	263	44233Y	79
42722	361	44103Y	263	44235C	195
43	487	44104R	263	44237C	294
433WD	304	44104Y	263	44239C	193
434WD	304	44110Y	260	44240C	193
435W	190	44114Y	260	44248Y	260
43A	487	44121R	13	44249Y	260
44001Y	58	44141C	193	44250C	191
44002R	19	44145C	194	44266C	193
44003Y	78	44146C	194	44266R	19
44021Y	59	44180C	191	44276Y	59
44022R	20	44181C	192	44291Y	76
44023Y	79	44182C	192	44292Y	77
44024Y	79	44183C	191	44293Y	77
44026R	20	44184C	191	44294Y	76
44027Y	59	44201Y	58	44295Y	77

Truck-Lite Part No. Page No. Truck-Lite Part No. Page No. Truck-Lite Part No. Page No.

44302R	14	44808	109	45041R	239
44304C	212	44809	109	45042R	21
44308C	295	44871Y	78	45051Y	61
44322R	16	44877Y	79	45058R	21
44326R	16	44878Y	79	45063Y	61
44328R	16	44881Y	58	45202R	37
44334R	16	44882R	19	45202Y	88
44339C	295	44883R	20	45204	201
44344C	192	44887Y	59	45207R	46
44345C	192	44888Y	59	45251Y	60
44346C	192	44931R	238	45256Y	61
44347C	191	44932R	13	45258R	20
44348C	192	44936R	13	45259R	21
44349C	192	44953R	17	45263Y	60
44350R	15	44954R	17	45323	359
44351R	15	44956R	17	45333	366
44352C	295	44959R	15	45333	369
44353R	15	44960R	15	45420	111
44353R	15	44972R	15	45421	111
44354R	15	44973R	15	45422	111
44355R	15	44974R	15	45423	111
44356R	17	44975R	17	45430	111
44357R	17	44980R	17	45433	111
44360R	17	44982R	14	4550	29
44361R	17	44983R	16	4558	29
44362R	17	44986R	16	4560C	197
44363R	17	44988R	16	45626	112
44365R	17	44990C	191	45627	112
44366R	17	44991C	192	45630	112
44367R	17	44992C	192	45631	112
44438C	295	45	486	45700	384
44439C	295	45001R	70	45701	384
44550R	18	45001Y	70	45740	117
44551R	18	45002R	38	45741	117
44700	384	45002Y	88	45742	117
44701	384	45004	201	45743	117
44705	369	45007R	46	45931R	239
44708	369	45021Y	70	45932R	21
44709	369	45024	201	45933R	239
44710	384	45032R	93	45934Y	60

Truck-Lite Part No.	Page No.	Truck-Lite Part No.	Page No.	Truck-Lite Part No.	Page No.
45A	486	50211	404	50350	406
47	486	5023	49	50351	405
4701	103	50230	404	50356	406
4702	103	50231	404	50357	407
47A	486	5023Y102	50	50367	407
47ADB	486	5024	49	50368	407
47DB	486	50240	400	50373	405
4800	104	50241	400	50374	405
4801	104	50242	404	50375	405
4805	104	50243	404	50376	405
4805AAY115	105	50250	401	50377	406
4805AAY118	105	50251	401	50381	407
4805AY116	105	50266	402	50382	407
4805AY117	105	50267	402	50383	406
4810	104	50282	400	50384	406
4854	102	50283	400	50385	406
4855	102	50300	403	50388	407
4872AA	102	50301	403	50400	440
4874AY101	105	50302	407	50401	440
49002R	30	50303	405	5050DK	174
49003C	205	50304	405	5051DK	174
49202R	30	50305	405	5055D	48
49203C	204	50307	405	5056D	48
50	502	50308	403	50600	441
5013	50	50309	406	50601	441
50133	399	50310	405	50602	443
5013K	50	50319	406	50606	445
5014	50	50321	406	50607	445
5014K	50	50322	407	50608	444
5014Y101	51	50324	406	50609	444
5014Y102	50	50325	401	5070	48
50151	399	50331	406	5071	48
50200	400	50334	403	5072	48
50201	400	50335	403	5073	48
50202	400	50338	401	50776	391
50203	400	50341	403	50776	408
50204	401	50342	402	50800	440
50208	404	50343	402	50801	440
50209	404	50344	402	50805	432
50210	404	50345	402	50806	432

Truck-Lite Part No. Page No. Truck-Lite Part No. Page No. Truck-Lite Part No. Page No.

50808	434	50896	436	57	487
50809	434	50898	433	57A	487
50812	444	50969	391	5800AA	105
50816	444	51270	401	5800AAK	105
50820	445	51271	401	60-50121	322
50822	432	51325	401	60-50123	322
50830	443	51342	402	60-50124	322
50831	368	51343	402	60001R	72
50832	445	51344	402	60001Y	72
50840	446	51345	402	60002R	39
50840	446	51355	402	60002Y	90
50840	446	51356	402	60004C	202
50841	447	51375	407	60007R	39
50842	447	51409	406	60013R	47
50845	443	52	486	60015R	71
50847	446	52100	403	60015Y	71
50850	445	52200	403	60021R	93
50860	437	52203	403	60022Y	88
50861	436	52700	390	60023R	93
50863	436	52733	399	60024Y	93
50865	436	52751	399	60050R	24
50866	437	528	176	60052R	25
50867	436	529	176	60056R	25
50868	437	52A	486	60060R	44
50869	435	530DK	176	60061R	44
50872	435	5315Y101	51	60062R	45
50875	433	5316Y101	51	60072Y	65
50878	432	533DK	175	60074Y	80
50879	432	534D	175	60075Y	64
508807	434	535D	175	60080Y	62
50882	434	536	333	60082Y	63
50883	434	54	488	60083R	39
50885	439	549SWD	305	60083Y	90
50886	435	54A	488	60085R	24
50887	439	550	333	60092C	203
50888	435	552	333	60094Y	80
50889	516	5554	176	60096Y	81
50890	433	55554-1	176	60097Y	81
50892	433	55650	529	60115Y	66
50895	433	55653	529	60117Y	67

Truck-Lite Part No.	Page No.	Truck-Lite Part No.	Page No.	Truck-Lite Part No.	Page No.
60120R	265	60302R	38	6063C	197
60120Y	265	60302Y	89	60700	384
60122R	264	60303R	46	60701	384
60122Y	264	60315Y	66	60704	385
60124R	266	60317Y	67	60708	384
60124Y	266	60324R	47	60718	367
60126R	266	60340R	38	60719	367
60126Y	266	60340Y	89	60720	364
60201R	71	60344R	71	60722	364
60201Y	71	60344Y	71	60723	364
60202R	39	60345C	202	60724	364
60202Y	89	60354C	212	60728	365
60207R	39	60356R	24	60729	365
60207Y	89	60360R	264	60730	365
60213R	47	60360Y	264	60731	366
60215R	163	60362R	264	60733	365
60215Y	70	60362Y	264	60737	367
60217Y	70	60364R	265	60738	366
60250R	24	60364Y	265	60789	341
60252R	25	60366R	265	60872Y	65
60253R	24	60366Y	265	60885R	24
60255Y	64	60403	385	60891Y	64
60256R	25	6050	28	60892Y	80
60260R	44	6050A	84	610W	224
60262R	45	6051	28	612W	246
60264R	24	6051A	84	613W	245
60266R	45	6053	28	620H	340
60272Y	65	6053A	84	620W	221
60275Y	64	60550R	23	620W4	221
60276Y	65	60551R	23	627WD	224
60280Y	62	60552R	23	628WD	224
60282Y	63	60553R	23	629WD	224
60283R	38	60554R	23	630H	340
60283Y	90	60555R	22	630W	221
60284C	202	60556R	22	630W4	221
60284C	203	60557R	22	631W	244
60286Y	63	60558R	487	632W	225
60290Y	80	6058	28	633W	225
60291Y	81	6058A	84	6500	73
60292Y	81	6060C	197	6500A	73

Truck-Lite Part No.	Page No.	Truck-Lite Part No.	Page No.	Truck-Lite Part No.	Page No.
6501	73	7038	470	80208	245
6501A	73	7039	470	80209	223
6503	72	7044	470	80220	217
6503A	73	7044DB	470	80240	218
6600A	280	7048	475	80250C	296
6600B	280	7048DB	475	80253C	297
6600MA	280	7217	465	80255C	297
6600W	280	7218	465	80275	238
6601A	279	7223	464	80302R	40
6601MA	279	7224	464	80302Y	92
66050R	26	7268	464	80304	204
66052R	26	7269	464	80322R	52
66054R	26	7450	476	80324R	52
66056R	26	7460	468	80334R	40
66082R	26	7519	467	80335R	40
66085R	26	7555	465	80336R	40
66205C	196	7575	467	80339R	40
66206C	196	7618	462	80340	203
66250R	25	7619	462	80342	204
66252R	26	77825	503	80344	204
66254R	26	794	492	80345	204
66256R	26	797	492	80360	220
6660PS	327	7973D	464	80361	220
66882R	26	798	492	80364	220
66885R	26	799	492	80368	244
6810A	280	8006	318	80373	220
6810MA	280	8007	318	80374	221
6811A	279	8008	318	80375	220
6811MA	279	8013	298	80378	220
6822A	277	80162C	296	80388	222
6823A	277	80162C	296	80389	247
69002Y	74	80163C	296	80394	222
69003C	206	80164C	296	80395	222
69202Y	74	80200	221	80396	222
69203C	206	80201	244	80397	223
70300	101	80202	221	80418	306
70310R	98	80203	221	80438	220
70311	99	80205	223	80444	306
70330R	97	80206	223	80461R	40
70330Y	97	80207	223	80462R	40



Truck-Lite Part No.	Page No.	Truck-Lite Part No.	Page No.	Truck-Lite Part No.	Page No.
80463R	40	80604	322	81260	213
80490	303	80700	322	81261	212
80491	223	80720	366	81270	213
80492	223	80722	366	81290	213
80493	223	80800	254	81295	213
80494	223	80805	255	81300R	74
80497	340	80810	252	81300Y	74
80498	222	80820	252	81335C	215
80513	247	80840	376	81350	303
80514	246	80844	376	81360	213
80519	246	80848	255	81365	213
80520	247	80849	255	81371	213
80521	246	80860	253	81374	213
80522	246	80867	94	81380	213
80525	245	80870	253	81385	213
80526	245	80873	250	81390	213
80560	320	80874	250	81391	213
80561	320	80875	250	81395	213
80562	320	80878	248	8140	217
80563	320	80879	248	8150	217
80564	320	80880	248	81500	216
80567	316	80888	253	81510	216
80568	316	80893	254	81520	216
80569	316	80900	251	8155	219
80571	320	80910	251	81560	215
80572	314	80920	251	8160	219
80573	314	80940	376	8170	219
80574	314	80970	425	81701	214
80578	316	80971	425	81702	214
80579	316	80972	425	81704	214
80580	316	80973	425	81711	214
80592	375	80974	425	81712	214
80593	375	80975	425	81714	214
80594	375	80988	249	8180	218
80596	321	80989	249	81801	214
80597	321	80990	249	81804	214
80598	321	81240	213	8192	219
80599	321	81245	213	8193	218
80602	369	81250	213	84200C	297
80603	369	81255	213	84720	242

Truck-Lite Part No.	Page No.	Truck-Lite Part No.	Page No.	Truck-Lite Part No.	Page No.
84740	243	8861A	318	8938	318
84760	241	88701	390	8938A	318
84761	242	88703	390	8939A	315
84764	242	88750	392	8943	310
84770	241	88751	392	8943A	310
84780	241	88810	390	8943W	310
87357	406	88820	390	8945	310
87358	406	88824	397	8945A	310
87621	471	88892	391	8946	313
87845	326	88896	391	8946A	313
87845	503	88896	392	8946W	313
88-02210	370	88900	392	8947	315
88-2126	323	88902	395	8947A	315
88-43210	324	88905	392	8948	318
88-88130	370	88910	393	8951W	341
8810	323	88911	394	8952W	341
88100	395	88915	393	8960	318
8812	324	88930	393	8960A	318
88175C	314	88931	394	8974	311
8820	323	88932	393	89751	392
8830	324	8900	315	8977A	313
88300	396	8900A	315	89810	391
88301	397	8909	310	900	514
88303	398	8918	314	9001	314
88307	398	8918A	314	9004	318
88308	395	8919	311	9004A	318
88338	395	8919A	311	9004G	318
88342	398	8923	316	9004W	318
88357	395	8923A	316	9005	314
88358	397	8925A	316	9005A	314
88367	396	8930	315	9005W	314
88368	396	8930A	315	9006	313
88372	396	8933	313	9006A	313
88373	398	8933A	313	9007	315
88377	398	8935W	311	9007A	313
88385	398	8936	310	9007B	313
88401	398	8936A	310	9007G	313
8850	324	8936B	310	9007W	313
88601	390	8937	313	900Y114	512
8861	318	8937A	313	900Y129	513

Truck-Lite Part No.	Page No.	Truck-Lite Part No.	Page No.	Truck-Lite Part No.	Page No.
900Y166	511	9063	318	91202R	42
900Y170	511	9063A	318	91202Y	91
900Y179	511	9071	317	91205R	42
900Y180	511	9072	317	91205Y	91
900Y205	512	9074A	318	91250	515
900Y206	512	9076W	310	91315R	42
900Y209	511	9077	313	91315Y	91
900Y73	511	9077A	313	91370Y	82
901	514	9077W	313	915Y103	511
9014	431	9078A	318	915Y104	513
9016	311	9079	318	915Y105	513
9016A	311	9079A	318	915Y113	510
9016B	311	9080A	315	915Y114	513
9016G	311	9081	310	915Y116	513
9016W	311	9081A	310	915Y117	513
902	514	9082	314	915Y119	510
9021	311	9082A	314	915Y124	513
9021A	311	9083	318	915Y128	510
9021W	311	9083A	318	9160	431
90251	510	9084A	318	9162	431
90251Y103	510	9087	313	9180	370
90251Y103-3	510	9087A	313	9183	410
9029	310	9088A	315	9185	411
9029A	310	9089	318	9186	334
9029B	310	9090	315	9187	334
9029W	310	9093	313	9190	376
903	514	9093A	313	9191	516
90327R	41	9093B	313	9196	516
90327Y	92	9093G	313	920	514
9041	310	9093W	313	92100	45
9041A	310	910	514	92101	45
9049	317	91002	515	92513Y	278
905	514	91002R	42	92516C	278
9057	315	91002Y	91	92516Y	278
9057A	315	9101	430	92522Y	285
9059	314	9102	431	92523Y	285
9059A	314	9103	431	92524Y	283
9059W	314	9105	430	92525B	283
9061	314	91150	515	92525Y	283
9061A	313	9120	370	92534Y	276

Truck-Lite Part No.	Page No.	Truck-Lite Part No.	Page No.	Truck-Lite Part No.	Page No.
92539Y	276	92711	323	92876Y	270
92547	326	92715	323	92877	364
92550Y	272	92716	327	92877	362
92551Y	271	92720	325	92878	364
92552Y	272	92721	325	92878	362
92553Y	272	92722	320	92879	363
92554Y	279	92760	287	9288	368
92555Y	272	927733	377	92880	363
92556Y	271	92800	325	92881	363
92557Y	271	92808	371	92883	321
92560	276	92810	321	92900	507
92563	276	92816	377	92901	507
92564C	275	92844	273	92902	507
92564Y	275	92845	273	92903	508
92565B	274	92846	270	92904	508
92565C	274	92849	287	92905	507
92565R	274	92855	267	92907	506
92565Y	274	92860Y	274	92909	506
92566Y	274	92862Y	276	9291	367
92568B	274	92863Y	276	92910	507
92568C	274	92864Y	275	92911	506
92568R	274	92865Y	274	92914	508
92568Y	274	92866Y	282	92916	508
92590Y	282	92867Y	282	92918	508
9260	409	92868Y	286	92923	507
92602B	277	92871B	268	92924	507
92602Y	277	92871C	268	92925	506
92620Y	277	92871R	268	92927	507
92668Y	284	92871Y	268	92WD	205
92669Y	285	92872B	268	93026R	38
92670Y	284	92872C	268	9341	310
92671Y	285	92872R	268	9341A	310
92672Y	284	92872Y	268	9341B	310
92673Y	283	92873R	269	9341G	310
92674Y	284	92873Y	269	9341W	310
92676Y	287	92874R	270	9342	314
92677Y	284	92874Y	270	9342A	314
92685Y	287	92876R	269	9371	315
92695Y	267	92876R	270	9371A	315
92696Y	267	92876Y	269	9371W	315

Truck-Lite Part No.	Page No.	Truck-Lite Part No.	Page No.	Truck-Lite Part No.	Page No.
9372	316	94840	424	950	102
9372A	316	94841	424	95001	419
9373W	316	94848	422	95002	419
93745	417	94850	422	95051	416
9382	318	94851	423	95119	410
9410BL	449	94853	416	95121	413
9414BL	449	94854	422	95122	413
9415BL	449	94861	417	95123	413
94236	412	94862	417	95124	413
94237	418	94865	421	95125	413
94609	417	94868	423	9520	370
9462	416	94882	424	9521	370
94624	417	94888	418	9522	370
9463	416	94897	421	95220	419
9467	431	94902	422	9523	370
9470	412	94909	422	95306	418
94706	415	94916	422	95332	408
94707	419	94919	422	9536	110
94718	417	94920	422	9537	110
94727	408	94922	416	95399	419
94729	408	94923	413	95400	420
94736	417	94924	423	95407	431
94750	415	94925	426	95410	420
94751	415	94926	426	95415	431
94759	419	94931	424	95424	419
94760	416	94932	415	95450	429
94766	419	94937	430	95451	429
94768	424	94938	430	95452	429
94769	415	94940	430	95453	429
94770	415	94948	426	95454	429
94789	414	94949	426	95455	429
94802	424	94954	409	95456	429
94811	409	94961	426	95457	429
94812	409	94962	426	95460	428
94813	409	94964	423	95461	428
94821	408	94966	417	95462	428
94831	417	94972	422	95463	428
94837	423	94991	423	95464	428
94838	423	94992	423	95465	428
94839	424	94993	424	95466	428

Truck-Lite Part No. Page No. Truck-Lite Part No. Page No. Truck-Lite Part No. Page No.

95467	428	96630	420	9710R	312
955	103	9674	326	9710W	312
956AA	103	9676	316	97126	378
957AA	103	96820	327	97140	523
95809	396	96904	408	97141	523
95846	420	96919	408	97142	523
95879	397	96927	421	97151	438
95910	377	96930	427	97153	438
95911	377	96932	427	97158	439
960Y100	512	96934	427	97159	439
960Y101	510	96936	427	97160	438
96106	414	97003	446	97161	438
96107	414	97005	418	9719A	310
96108	414	97006	418	9720	311
96193	501	97011	447	97201	332
96199	522	9702	326	9720A	311
961Y100	512	97020	520	9720B	311
96247	419	97020B	520	9720W	311
96248	408	97022	522	97224	375
96249	422	97029	523	97231	332
96250	426	97031	371	97232	332
96251	414	97032	371	97233	332
96252	418	97034	371	97235	330
96253	413	97035	371	9723A	312
96254	421	97036	371	97251	330
96255	421	97038	371	97253	330
96256	421	97039	372	97254	331
96257	500	97046	372	97270	332
96258	502	97050	372	97271	332
96259	500	9705A	312	97272	332
96260	500	9705B	312	97282	501
962Y100	512	9705R	312	97283	333
962Y101	512	9705W	312	97288	378
962Y102	510	97073	372	97300	335
963Y100	512	97079	372	97302	335
963Y101	512	97080	372	97322	501
963Y102	512	97093	372	97330	500
964Y100	512	97094	372	97334	368
96511	442	97100	500	97337	368
96512	442	97101	501	97340	411

Truck-Lite Part No.	Page No.	Truck-Lite Part No.	Page No.	Truck-Lite Part No.	Page No.
97342	411	97611	462	97669	453
97344	427	97612	462	97670	476
97345	411	97614	473	97671	476
97349	411	97615	473	97672	467
97364	410	97618	470	97674	466
97365	411	97619	470	97675	466
97366	427	97620	470	97676	466
97376	524	97622	471	97678	463
97377	524	97623	471	97680	469
97378	526	97624	459	97681	469
97379	527	97625	460	97682	469
97380	526	97627	455	97686	472
97381	525	97628	455	97687	472
97382	503	97629	455	97688	473
97383	525	97630	456	97693	457
97384	465	97631	456	97694	456
97388	503	97632	454	97695	478
97389	448	97633	457	97701	373
97390	448	97634	455	97706	374
97391	448	97635	457	97718	479
97392	503	97636	458	97719	480
97405	525	97637	458	9771A	315
97406	528	97643	454	97720	481
97408	528	97644	454	97721	482
97432	378	97650	461	97722	482
97437	410	97652	454	97724	316
97480	528	97653	462	97725	478
97482	524	97654	462	97726	478
97483	524	97655	463	97730	480
97484	526	97656	463	97731	481
97485	527	97657	463	97732	482
97486	527	97659	467	97733	482
97487	525	97660	468	97748	481
97488	525	97661	468	97750	466
97489	525	97662	468	97794	466
97602	476	97664	472	97799	502
97603	476	97665	472	97802	471
97606	473	97666	479	97803	474
97609	475	97667	475	97804	474
97610	475	97668	453	97805	468

Truck-Lite Part No. Page No. Truck-Lite Part No. Page No. Truck-Lite Part No. Page No.

97806	459	97882	522	98020B	521
97807	462	97905	373	98021	522
97808	459	97912	444	98022	522
97809	458	97913	446	98031R	488
97811	459	97913	447	98031Y	488
97812	455	97920	520	98033R	489
97814	474	97920B	520	98033Y	489
97815	472	97921	373	98034R	489
97816	472	97925	373	98034Y	489
97817	472	97927	373	98035R	488
97819	471	97929	444	98035Y	488
97820	471	97933	373	98050	499
97822	458	97940	498	98051	499
97823	483	97943	498	98052	499
97826	460	97944	498	98053	499
97827	460	97945	373	98054	499
97828	479	97946	498	98056	499
97829	479	97947	373	98057	499
97831	474	97948	498	98058	499
97835	475	97955	448	98100	490
97836	458	97956	448	98101	490
97837	460	97960	502	98102	490
97839	458	97973	467	98104	490
97840	461	97980	340	98105	490
97843	478	97987	374	98107	490
97845	483	97989	340	98108	490
97846	453	98000	522	98111	490
97847	467	98001R	488	98113	490
97848	476	98001Y	488	98126	490
97849	483	98003R	488	98127	490
97852	469	98003RB	488	98136	490
97860	455	98003Y	488	98137	490
97861	458	98003YB	488	98138	490
97862	474	98004R	487	98144	490
97863	474	98004Y	487	98146	490
97865	476	98006C	486	98153	489
97866	459	98006R	486	98154R	489
97869	481	98006Y	486	98155	489
97872	471	98013	498	98165	491
97876	480	98020	521	98167	491



Truck-Lite Part No.	Page No.	Truck-Lite Part No.	Page No.	Truck-Lite Part No.	Page No.
98168	491	99035Y	310	99127R	316
98170	491	99039R	318	99143C	312
98175RB	486	99039Y	318	99143Y	312
98175RB	486	99041R	313	99147Y	310
98175Y	486	99041Y	313	99150C	311
98175YB	486	99043R	313	99151Y	317
98176R	489	99043Y	313	99152	317
98176RB	489	99044R	310	99158Y	314
98176Y	489	99044Y	310	99160C	314
98176YB	489	99050R	313	99160R	315
9832	318	99050Y	313	99160Y	315
9832W	318	99051R	313	99165Y	318
9834	318	99051Y	313	99167Y	312
9834A	318	99063R	318	99168C	312
99001R	310	99063Y	318	99168R	312
99001Y	310	99066Y	311	99168Y	312
99005C	310	99067R	313	99169R	312
99005R	310	99067Y	313	99169Y	312
99005Y	310	99074Y	312	99170R	315
99007C	310	99080C	311	99170Y	315
99007R	310	99082C	311	99172	316
99007Y	310	99082R	311	99176C	311
99008C	311	99083R	311	99184C	314
99008R	311	99086R	316	99184R	314
99008Y	311	99086Y	316	99184Y	314
99009R	310	99087R	316	99192Y	317
99009Y	310	99087Y	316	99193Y	317
99010C	311	99088C	312	99200C	314
99010R	311	99088R	312	99200Y	314
99010Y	311	99090R	310	99203Y	317
99011R	313	99090Y	310	99204Y	317
99011Y	313	99101R	311	99205Y	317
99012R	315	99104R	310	99205Y	317
99012Y	315	99105R	310	99220B	312
99021R	312	99107Y	310	99220R	312
99021Y	312	99108Y	312	99220W	312
99027Y	313	99120B	310	99221B	312
99034R	310	99120C	310	99221R	312
99034Y	310	99120R	310	99221W	312
99035R	310	99126R	316	99221Y	312

## Truck-Lite Part No.      Page No.

99226Y	317
99227Y	317
99233C	315
99234C	315
99235C	316
99236C	316
99238R	315
99238Y	315
99245C	317
99250B	312
99250C	312
99250Y	312
99252C	312
99252Y	312
L48SM	523
L4HEADER	521
LENDCAPHEADER	521
P340	523
P440	523



## MARKER & CLEARANCE LIGHTS

### ROUND

Pages 3-4

#### LED

SERIES	COMMON SIZE	PAGES
Signal-Stat	2"	3
Signal-Stat	2.5"	3

#### INCANDESCENT

SERIES	COMMON SIZE	PAGES
Signal-Stat	2"	4
Signal-Stat	2.5"	4

### RECTANGULAR

Pages 5-8

#### LED

SERIES	COMMON SIZE	PAGES
Signal-Stat	1"x2"	5
Signal-Stat	1"x4"	5
Signal-Stat	2"x3"	6
Signal-Stat	2"x4"	6
Signal-Stat	2"x6"	6

#### INCANDESCENT

SERIES	COMMON SIZE	PAGES
Signal-Stat	1"x2"	7
Signal-Stat	2"x3"	7
Signal-Stat	2"x4"	7-8
Signal-Stat	2"x6"	8

### OVAL

Page 9

#### INCANDESCENT

SERIES	COMMON SIZE	PAGES
Signal-Stat	1"x3"	9
Signal-Stat	1"x4"	9
Signal-Stat	2"x4"	9

### TRIANGULAR

Page 10

#### INCANDESCENT

SERIES	COMMON SIZE	PAGES
Signal-Stat	1"x4"	10
Signal-Stat	1"x5"	10
Signal-Stat	2"x3"	10
Signal-Stat	3"x4"	10

### BEEHIVE

Page 11

#### LED

SERIES	COMMON SIZE	PAGES
Signal-Stat	2"	11
Signal-Stat	2.5"	11
Signal-Stat	3"x4"	11

#### INCANDESCENT

SERIES	COMMON SIZE	PAGES
Signal-Stat	2"	11

**!** Look up by part number on the next page. **→**

# NUMERICAL INDEX

Truck-Lite Part No. Page No.

1001	11
1001A	11
1050	3
1050A	3
1051	3
1051A	3
1052	3
1052A	3
1053	3
1053A	3
1058	3
1058A	3
1070	3
1070A	3
1075	11
1075A	11
1076	11
1076A	11
1101	7
1101A	7
1102	7
1102A	7
1105	7
1105A	7
1115	4
1115A	4
1116	4
1116A	4
1150	10
1150A	10
1155	11
1155A	11
1203	7
1203A	7
1211	8
1211A	8
1213	8
1213A	8
1222	8
1222A	8

Truck-Lite Part No. Page No.

1233	8
1233A	8
1259	7
1259A	7
1259B	9
1259G	9
1264	9
1264A	9
1312A	10
1313A	10
1319	4
1319A	4
1320A	10
1350A	8
1506	7
1506A	7
1507	7
1507A	7
1520AHT	10
1520HT	10
1550	9
1550A	9
1551	9
1551A	9
1555	9
1555A	9
1560	5
1560A	5
1561	5
1561A	5
1570	7
1570A	7
1571	8
1571A	8
1590A	4
1960	5
1960A	5
1961	5
1961A	5
2150	6

Truck-Lite Part No. Page No.

2150A	6
2152	6
2152A	6
2660	6
2660A	6
2661	6
2661A	6
2671	6
2671A	6
2672A	5
2673	5
2673A	5
2674	6
2674A	6
2675	6
2675A	6
3050	3
3050A	3
3051	3
3051A	3
3053	3
3053A	3
3058	3
3058A	3
3059A	3
3070	3
3070A	3
3075	11
3075A	11
3076	11
3076A	11
3550	5
3550A	5
5052AD	6

# SIGNAL-STAT, LED, 2", ROUND

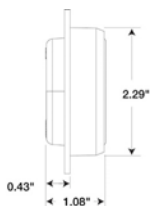

FLANGE

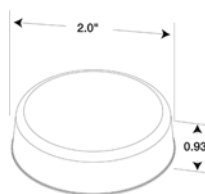

GROMMET

LED  
2 IN ROUND

Part Number	Mount Type	Mount Color	Lens Color	Lamp Connector	Volts	Amps	Diodes	Lighting Codes	Reflectorized
3058	Grommet		Red	PL-10	12	0.05	1	P2 PC	No
3050	Grommet		Red	PL-10	12	0.05	10	P2 PC	No
3058A	Grommet		Yellow	PL-10	12	0.05	1	P2 PC	No
3050A	Grommet		Yellow	PL-10	12	0.05	10	P2 PC	No
3051	Grommet		Clear Red	PL-10	12	0.05	10	P2 PC	No
3051A	Grommet		Clear Yellow	PL-10	12	0.05	10	P2 PC	No
3059A	Grommet		Yellow	PL-10	12	0.05	10	P2	No
3070	Flange	Gray	Red	PL-10	12	0.05	10	P2 PC	No
3070A	Flange	Gray	Yellow	PL-10	12	0.05	10	P2 PC	No
3053	Flange	Gray	Red	PL-10	12	0.06	10	P2 PC	No
3053A	Flange	Gray	Yellow	PL-10	12	0.06	10	P2 PC	No

# SIGNAL-STAT, LED, 2.5", ROUND

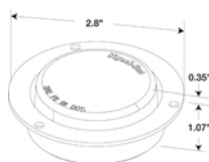

FLUSH

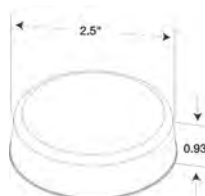

GROMMET

LED  
2.5 IN ROUND

Part Number	Mount Type	Mount Color	Lens Color	Lamp Connector	Volts	Amps	Diodes	Lighting Codes	Reflectorized
1050	Grommet		Red	PL-10	12	0.01	13	P2 PC	No
1050A	Grommet		Yellow	PL-10	12	0.01	13	P2 PC	No
1058	Grommet		Red	PL-10	12	0.05	1	P2 PC	No
1058A	Grommet		Yellow	PL-10	12	0.05	1	P2 PC	No
1051	Grommet		Clear Red	PL-10	12	0.01	13	P2 PC	No
1051A	Grommet		Clear Yellow	PL-10	12	0.01	13	P2 PC	No
1052	Grommet		Red	PL-10	12	0.01	4	A P2	Yes
1052A	Grommet		Yellow	PL-10	12	0.01	4	A P2	Yes
1070	Flush	Gray	Red	PL-10	12	0.01	13	P2 PC	No
1070A	Flush	Gray	Yellow	PL-10	12	0.01	13	P2 PC	No
1053	Flush	Gray	Red	PL-10	12	0.11	13	P2 PC	No
1053A	Flush	Gray	Yellow	PL-10	12	0.11	13	P2 PC	No

## SIGNAL-STAT, INCANDESCENT, 2", ROUND



Part Number	Mount Type	Mount Color	Lens Color	Lamp Connector	Plug Side 1	Plug Side 2	Volts	Amps	Diodes	Lighting Codes	Reflectorized
1115	Flange	Silver	Red	Socket Assembly	Socket Assembly	Stripped End	12	0.05	1	PC	No
1115A	Flange	Silver	Yellow	Socket Assembly	Socket Assembly	Stripped End	12	0.05	1	PC	No

## SIGNAL-STAT, INCANDESCENT, 2.5", ROUND



2 SCREW

2 STUD

FLANGE

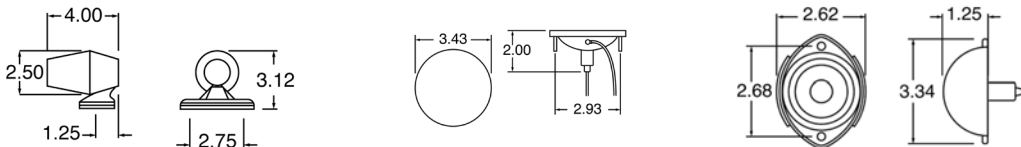

Part Number	Mount Type	Mount Color	Lens Color	Lamp Connector	Plug Side 1	Plug Side 2	Volts	Amps	Diodes	Lighting Codes	Reflectorized
1319	2 Screw	Chrome	Red	Hardwired	Hardwired	Stripped End	12	0.35	1	P2 PC	No
1319A	2 Screw	Chrome	Yellow	Hardwired	Hardwired	Stripped End	12	0.35	1	P2 PC	No
1590A	2 Stud		Yellow	Hardwired	Hardwired	Ring Terminal	12	0.35	1	A P2	Yes
1116	Flange	Silver	Red	Socket Assembly	Socket Assembly	Stripped End	12	0.59	1	P2 PC	No
1116A	Flange	Silver	Yellow	Socket Assembly	Socket Assembly	Stripped End	12	0.59	1	P2 PC	No

## SIGNAL-STAT, LED, 1"X 2", RECTANGULAR

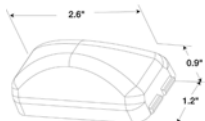

1561



1561A



1560



1560A

Part Number	Mount Type	Lens Color	Lamp Connector	Volts	Amps	Diodes	Lighting Codes
1561	Grommet	Clear Red	PL-10	12	0.05	1	P2 PC
1561A	Grommet	Clear Yellow	PL-10	12	0.05	10	P2 PC
1560	Grommet	Red	PL-10	12	0.05	1	P2 PC
1560A	Grommet	Yellow	PL-10	12	0.05	10	P2 PC

LED  
1X2 IN RECTANGULAR

## SIGNAL-STAT, LED, 1"X 4", RECTANGULAR

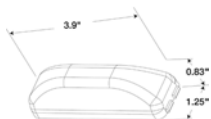

1960



1960A



3550



1960A



1961A



3550A

Part Number	Mount Type	Mount Color	Lens Color	Lamp Connector	Plug Slide 1	Plug Slide 2	Volts	Amps	Diodes	Lighting Codes
1960	Bracket		Red	Male Pin			12	0.05	4	P2 PC
1960A	Bracket		Yellow	19 Series Male Pin			12	0.05	4	P2 PC
1961	Bracket		Clear Red	19 Series Male Pin			12	0.05	4	P2 PC
1961A	Bracket		Clear Yellow	19 Series Male Pin			12	0.05	4	P2 PC
3550	2 Screw	Red	Red	Hardwired	Hardwired	Ring Terminal  Stripped End	12	0.05	2	P2 PC
3550A	2 Screw	Yellow	Yellow	Hardwired	Hardwired	Ring Terminal  Stripped End	12	0.05	2	P2 PC

LED  
1X4 IN RECTANGULAR

## SIGNAL-STAT, LED, 1"X 4", RECTANGULAR, KIT

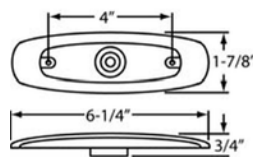

2672A



2673



2673A

Part Number	Mount Type	Mount Color	Lens Color	Lamp Connector	Plug Slide 1	Plug Slide 2	Volts	Amps	Diodes	Lighting Codes
2672A	2 Screw	Chrome	Yellow	Hardwired	Hardwired	Ring Terminal  Stripped End	12	0.05	2	P2 PC
2673	2 Screw	Chrome	Red	Hardwired	Hardwired	Ring Terminal  Stripped End	12	0.05	12	P2 PC
2673A	2 Screw	Chrome	Yellow	Hardwired	Hardwired	Ring Terminal  Stripped End	12	0.05	12	P2 PC

LED  
1X4 IN RECTANGULAR  
KIT

**SIGNAL-STAT, LED, 2" X 3", RECTANGULAR**

LED  
2X3 IN RECTANGULAR  
LED  
2X4 IN RECTANGULAR  
LED  
2X6 IN RECTANGULAR

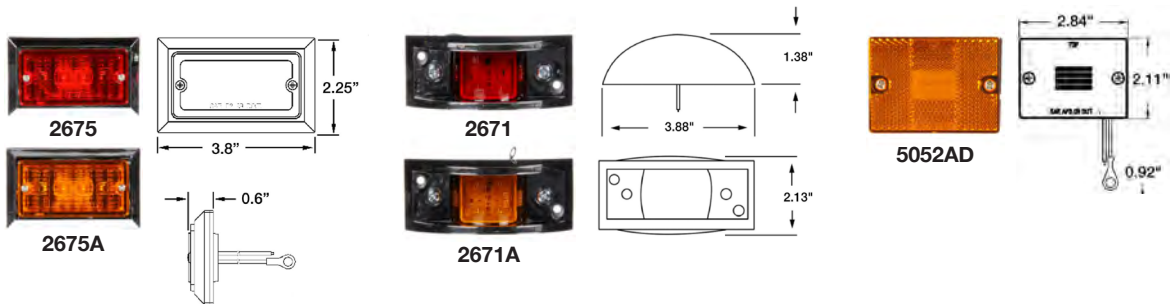

Part Number	Mount Type	Mount Color	Lens Color	Lamp Connector	Plug Side 1	Plug Side 2	Volts	Amps	Diodes	Lighting Codes
2675	2 Screw	Red	Red	Hardwired	Hardwired	Ring Terminal  Stripped End	12	0.06	2	P2 PC
2675A	2 Screw	Yellow	Yellow	Hardwired	Hardwired	Ring Terminal  Stripped End	12	0.06	2	P2 PC
2671	Rail	Chrome	Red	Hardwired	Hardwired	Stripped End  Ring Terminal	12	0.07	4	P2 PC
2671A	Rail	Chrome	Yellow	Hardwired	Hardwired	Stripped End  Ring Terminal	12	0.07	4	P2 PC
5052AD	1 Stud	Silver	Yellow	Hardwired	Hardwired	Stripped End  Ring Terminal	12	0.05	6	P2 PC

**SIGNAL-STAT, LED, 2" X 4", RECTANGULAR**



Part Number	Mount Type	Mount Color	Lens Color	Lamp Connector	Plug Side 1	Plug Side 2	Volts	Amps	Diodes	Lighting Codes
2661	2 Screw		Clear Red	Hardwired	Hardwired	Blunt Cut	12	0.08	16	P2 PC
2661A	2 Screw		Clear Yellow	Hardwired	Hardwired	Blunt Cut	12	0.08	16	P2 PC
2660	2 Screw		Red	Hardwired	Hardwired	Blunt Cut	12	0.08	16	P2 PC
2660A	2 Screw		Yellow	Hardwired	Hardwired	Blunt Cut	12	0.08	16	P2 PC
2674	2 Screw	Red	Red	Hardwired	Hardwired	Stripped End	12	0.07	8	P2 PC
2674A	2 Screw	Yellow	Yellow	Hardwired	Hardwired	Stripped End	12	0.07	8	P3

**SIGNAL-STAT, LED, 2" X 6", RECTANGULAR**



Part Number	Mount Type	Mount Color	Lens Color	Lamp Connector	Plug Side 1	Plug Side 2	Volts	Amps	Diodes	Lighting Codes	Reflectorized
2152	2 Screw		Clear Red	Hardwired	Hardwired	Stripped End	12	0.12	8	P2, PC	No
2152A	2 Screw		Clear Yellow	Hardwired	Hardwired	Stripped End	12	0.12	8	P2, PC	No
2150	2 Screw	Red	Red	Hardwired	Hardwired	Stripped End	12	0.12	8	A P2	Yes
2150A	2 Screw	Yellow	Yellow	Hardwired	Hardwired	Stripped End	12	0.12	8	A P2	Yes



# SIGNAL-STAT, INCANDESCENT, 1" X 2", RECTANGULAR

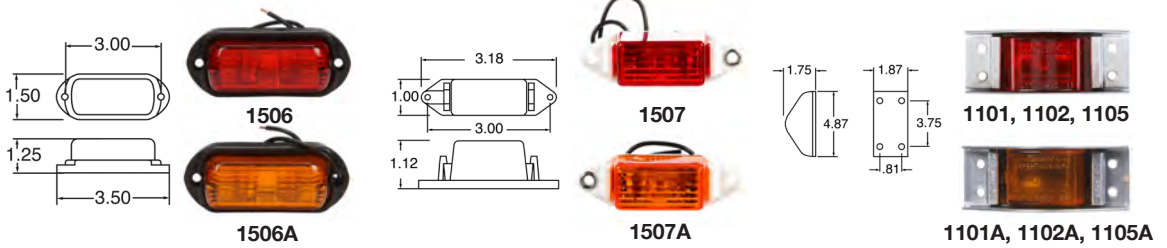

Part Number	Mount Type	Mount Color	Lens Color	Lamp Connector	Plug Side 1	Plug Side 2	Volts	Amps	Diodes	Lighting Codes
1101	4 Screw	Silver	Red	Hardwired	Hardwired	Stripped End	12	0.35	1	P2 PC
1101A	4 Screw	Silver	Yellow	Hardwired	Hardwired	Stripped End	12	0.35	1	P2 PC
1102	4 Screw	Silver	Red	Hardwired	Hardwired	Stripped End	12	0.35	1	P2 PC
1102A	4 Screw	Silver	Yellow	Hardwired	Hardwired	Stripped End	12	0.35	1	P2 PC
1105	4 Screw	Silver	Red	Hardwired	Hardwired	Stripped End	12	0.27	1	P2 PC
1105A	4 Screw	Silver	Yellow	Hardwired	Hardwired	Stripped End	12	0.27	1	P2 PC
1507	2 Screw	White	Red	Hardwired	Hardwired	Stripped End	12	0.27	1	P2
1507A	2 Screw	White	Yellow	Hardwired	Hardwired	Stripped End	12	0.27	1	P2
1506	2 Screw		Red	Hardwired	Hardwired	Stripped End	12	0.07	2	P2 PC
1506A	2 Screw		Yellow	Hardwired	Hardwired	Stripped End	12	0.07	2	P2 PC

# SIGNAL-STAT, INCANDESCENT, 2" X 3", RECTANGULAR



Part Number	Mount Type	Mount Color	Lens Color	Lamp Connector	Plug Side 1	Plug Side 2	Volts	Amps	Diodes	Lighting Codes
1570	1 Stud		Red	Hardwired	Hardwired	Stripped End	12	0.33	1	A P2
1570A	1 Stud	Yellow	Yellow	Hardwired	Hardwired	Stripped End	12	0.33	1	A P2

# SIGNAL-STAT, INCANDESCENT, 2" X 4", RECTANGULAR, KIT

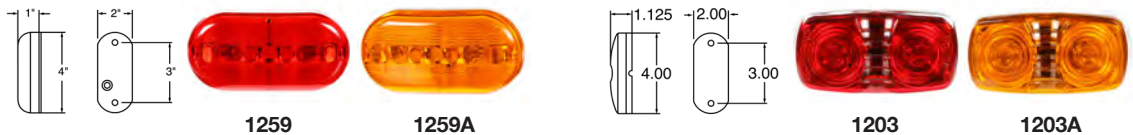

Part Number	Mount Type	Lens Color	Lamp Connector	Plug Side 1	Plug Side 2	Volts	Amps	Diodes	Lighting Codes	Replacement Parts
1203	Bracket	Red	Hardwired	Hardwired	Blunt Cut	12	0.33	2	P2 PC	9006 lamp, 9523 pad, 9180 O-ring
1203A	Bracket	Yellow	Hardwired	Hardwired	Blunt Cut	12	0.33	2	P2 PC	9006A lamp, 9523 pad, 9180 O-ring
1259	Bracket	Red	Hardwired	Hardwired	Stripped End	12	0.27	2	P2 PC	9093 lamp, 9522 pad
1259A	Bracket	Yellow	Hardwired	Hardwired	Stripped End	12	0.27	2	P2 PC	9093A lamp, 9522 pad

# SIGNAL-STAT, INCANDESCENT, 2" X 4", RECTANGULAR

INCANDESCENT

2X4 IN RECTANGULAR

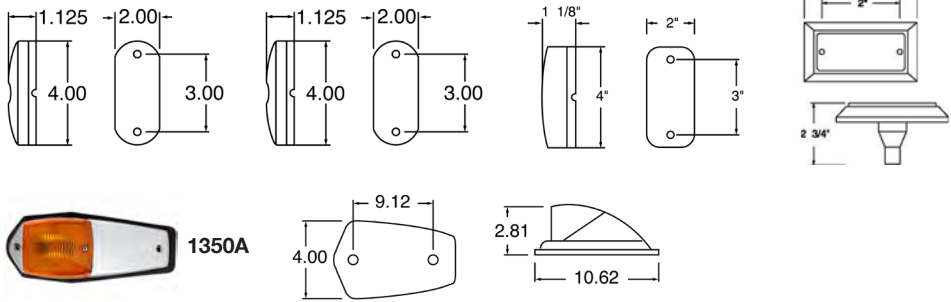
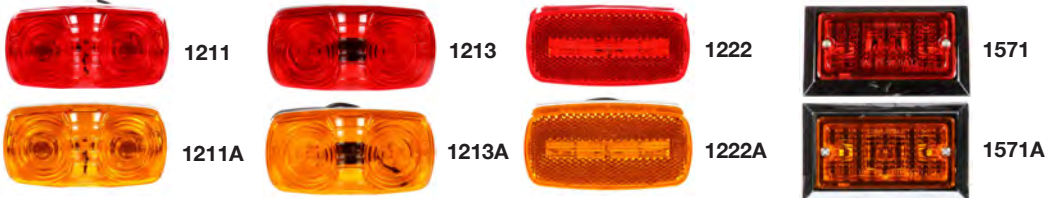

Part Number	Mount Type	Mount Color	Lens Color	Lamp Connector	Plug Side 1	Plug Side 2	Volts	Amps	Diodes	Lighting Codes	Reflectorized
1211	2 Screw		Red	Hardwired	Hardwired	Blunt Cut	12	0.27	2	P2 PC	No
1211A	2 Screw		Yellow	Hardwired	Hardwired	Blunt Cut	12	0.27	2	P2 PC	No
1213	2 Screw		Red	Hardwired	Hardwired	Blunt Cut	12	0.35	2	P2 PC	No
1213A	2 Screw		Yellow	Hardwired	Hardwired	Blunt Cut	12	0.35	2	P2 PC	No
1350A	2 Screw	Silver	Yellow	Hardwired	Hardwired	Stripped End	12	0.35	1	P2 PC	No
1222	2 Screw		Red	Hardwired	Hardwired	Stripped End	12	0.27	8	A P2	Yes
1222A	2 Screw	Red	Yellow	Hardwired	Hardwired	Stripped End	12	0.27	8	P2	Yes
1571A	2 Screw	Silver	Yellow	Hardwired	Hardwired	Stripped End	12	0.33	8	P2	No
1571	2 Screw	Chrome	Red	Hardwired	Hardwired	Stripped End	12	0.27	8	P2	No

# SIGNAL-STAT, INCANDESCENT, 2" X 6", RECTANGULAR

INCANDESCENT

2X6 IN RECTANGULAR

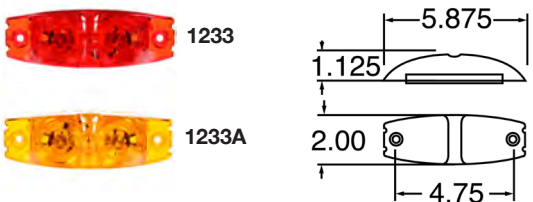

Part Number	Mount Type	Mount Color	Lens Color	Lamp Connector	Plug Side 1	Plug Side 2	Volts	Amps	Diodes	Lighting Codes
1233	2 Screw	Red	Red	Hardwired	Hardwired	Stripped End	12	0.33	2	P2 PC
1233A	2 Screw	Yellow	Yellow	Hardwired	Hardwired	Stripped End	12	0.33	2	P2 PC

# SIGNAL-STAT, INCANDESCENT, 1"X 3", OVAL

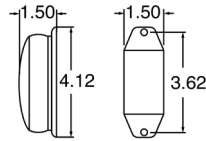
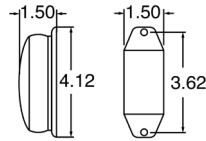

Part Number	Mount Type	Mount Color	Lens Color	Lamp Connector	Volts	Amps	Diodes	Lighting Codes
1550	2 Screw	White	Red	2 Female .156 Bullet Terminal	12	0.05	1	P2 PC
1550A	2 Screw	White	Yellow	2 Female .156 Bullet Terminal	12	0.05	1	P2 PC
1551	Rail	White	Yellow	2 Female .156 Bullet Terminal	12	0.05	1	P2 PC
1551A	Rail	White	Yellow	2 Female .156 Bullet Terminal	12	0.05	1	P2 PC

INCANDESCENT

1X3 IN OVAL

# SIGNAL-STAT, INCANDESCENT, 1"X 4", OVAL

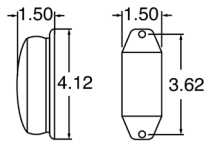

Part Number	Mount Type	Lens Color	Lamp Connector	Plug Side 1	Plug Side 2	Volts	Amps	Diodes	Lighting Codes
1555	2 Screw	Red	Hardwired	Hardwired	Stripped End	12	0.27	1	P2 PC
1555A	2 Screw	Yellow	Hardwired	Hardwired	Stripped End	12	0.27	1	P2 PC

INCANDESCENT

1X4 IN OVAL

# SIGNAL-STAT, INCANDESCENT, 2"X 4", OVAL

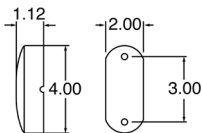

Part Number	Mount Type	Lens Color	Lamp Connector	Plug Side 1	Plug Side 2	Volts	Amps	Diodes	Lighting Codes	Reflectorized
1259B	Bracket	Blue	Hardwired	Hardwired	Stripped End	12	0.27	2	P2 PC	No
1259G	Bracket	Green	Hardwired	Hardwired	Stripped End	12	0.27	2	P2 PC	No
1264	Bracket	Red	Hardwired	Hardwired	Stripped End	12	0.33	2	A P2	Yes
1264A	Bracket	Yellow	Hardwired	Hardwired	Stripped End	12	0.33	2	A P2	Yes

INCANDESCENT

2X4 IN OVAL

## SIGNAL-STAT, INCANDESCENT, 1"X 4", TRIANGULAR, KIT

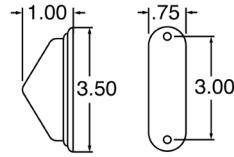

Part Number	Mount Type	Lens Color	Lamp Connector	Plug Side 1	Plug Side 2	Volts	Amps	Diodes	Lighting Codes	Replacement Parts
1520AHT	2 Screw	Yellow	Hardwired	Hardwired	.180 Bullet	12	0.27	1	P2 PC	9082 lens
1520HT	2 Screw	Red	Hardwired	Hardwired	.180 Bullet	12	0.27	1	P2 PC	9082A lens

## SIGNAL-STAT, INCANDESCENT, 1"X 5", TRIANGULAR

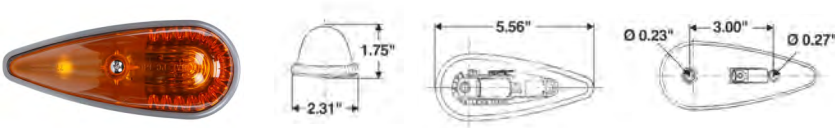

Part Number	Mount Type	Lens Color	Lamp Connector	Plug Side 1	Plug Side 2	Volts	Amps	Diodes	Lighting Codes
1320A	2 Screw	Yellow	Socket Assembly	Socket Assembly	Stripped End	12	0.59	1	P2 PC

## SIGNAL-STAT, INCANDESCENT, 2"X 3", TRIANGULAR

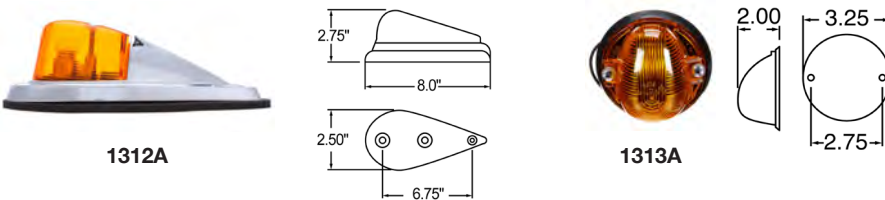

Part Number	Mount Type	Mount Color	Lens Color	Lamp Connector	Plug Side 1	Plug Side 2	Volts	Amps	Diodes	Lighting Codes
1312A	2 Screw	Chrome	Yellow	Hardwired	Hardwired	Stripped End	12	0.59	1	P2 PC
1313A	2 Screw		Yellow	Hardwired	Hardwired	Stripped End	12	0.35	1	P2 PC

## SIGNAL-STAT, INCANDESCENT, 3"X 4", TRIANGULAR

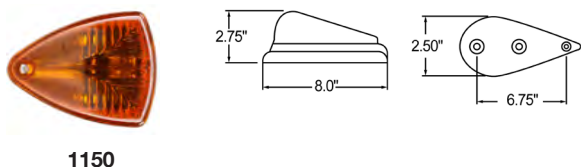

Part Number	Mount Type	Mount Color	Lens Color	Lamp Connector	Plug Side 1	Plug Side 2	Volts	Amps	Diodes	Lighting Codes
1150	2 Screw	Chrome	Yellow	Hardwired	Hardwired	Stripped End	12	0.59	1	P2 PC
1150A	2 Screw		Yellow	Hardwired	Hardwired	Stripped End	12	0.35	1	P2 PC

## SIGNAL-STAT, LED, 2", BEEHIVE

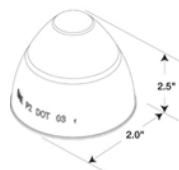

3076/3076A 3075 3075A

Part Number	Mount Type	Mount Color	Lens Color	Lamp Connector	Plug Side 1	Plug Side 2	Volts	Amps	Diodes	Lighting Codes
3075	Grommet		Red	PL-10	No Plug	No Plug	12	0.1	10	P2 PC
3075A	Grommet		Yellow	PL-10	No Plug	No Plug	12	0.1	10	P2 PC
3076	Grommet		Clear Red	PL-10	No Plug	No Plug	12	0.1	10	P2 PC
3076A	Grommet		Clear Yellow	PL-10	No Plug	No Plug	12	0.1	10	P2 PC

## SIGNAL-STAT, LED, 2.5", BEEHIVE



1076/1076A 1075 1075A

Part Number	Mount Type	Mount Color	Lens Color	Lamp Connector	Plug Side 1	Plug Side 2	Volts	Amps	Diodes	Lighting Codes
1075	Grommet		Red	PL-10	No Plug	No Plug	12	0.1	13	P2 PC
1075A	Grommet		Yellow	PL-10	No Plug	No Plug	12	0.1	13	P2 PC
1076	Grommet		Clear Red	PL-10	No Plug	No Plug	12	0.1	13	P2 PC
1076A	Grommet		Clear Yellow	PL-10	No Plug	No Plug	12	0.1	13	P2 PC

## SIGNAL-STAT, LED, 3" X 4", BEEHIVE

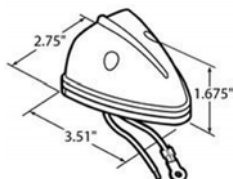

1155 1155A

Part Number	Mount Type	Mount Color	Lens Color	Lamp Connector	Plug Side 1	Plug Side 2	Volts	Amps	Diodes	Lighting Codes
1155	Grommet	Red	Red	Hardwired	Hardwired	Stripped End	12	0.12	13	P2 PC
1155A	Grommet	Yellow	Yellow	Hardwired	Hardwired	Stripped End	12	0.12	13	P2 PC

## SIGNAL-STAT, INCANDESCENT, 2", BEEHIVE

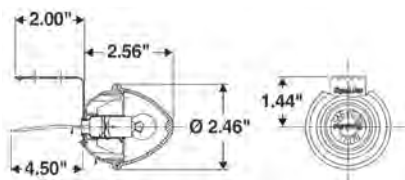

3076/3076A 3075 3075A 1001 1001A

Part Number	Mount Type	Mount Color	Lens Color	Lamp Connector	Plug Side 1	Plug Side 2	Volts	Amps	Diodes	Lighting Codes
1001	2 Screw	Silver	Red	Hardwired	Hardwired	Stripped End	12	0.59	1	P2 PC
1001A	2 Screw	Silver	Yellow	Hardwired	Hardwired	Stripped End	12	0.35	1	P2 PC
3075	Grommet		Red	PL-10	No Plug	No Plug	12	0.1	10	P2 PC
3075A	Grommet		Yellow	PL-10	No Plug	No Plug	12	0.1	10	P2 PC
3076	Grommet		Clear Red	PL-10	No Plug	No Plug	12	0.1	10	P2 PC
3076A	Grommet		Clear Yellow	PL-10	No Plug	No Plug	12	0.1	10	P2 PC



# FIND IT ON TRUCK-LITE.COM

With over 8,000 available parts,  
you'll be sure to find what you need.  
Visit [www.truck-lite.com](http://www.truck-lite.com) today.



**Powerful Search**



**360° Product Images**



**Easy-To-Find  
Replacement  
Parts**





## Corporate

corporate@truck-lite.com  
(800) 888-7095

## Customer Service

customerservice@truck-lite.com  
(800) 562-5012

## Technical Support

tltech@truck-lite.com  
(888) 562-5012



[truck-lite.com](http://truck-lite.com)

SEE & BE SEEN®



DESIGNED & PRINTED  
IN THE USA